

PRODUCT CATALOG

Microwave Connectivity for Military, Space and Laboratory Testing Applications

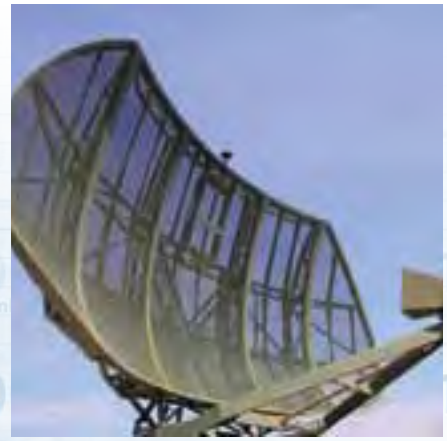
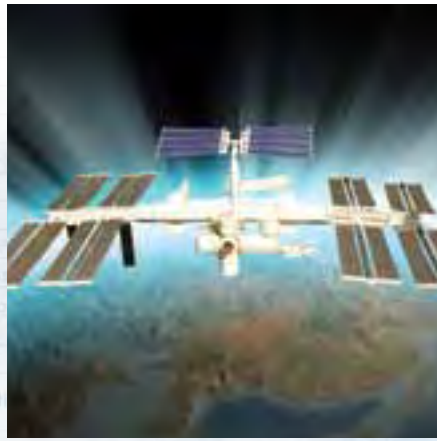

EMERSON
Network Power

Midwest Microwave
Connectivity Solutions

Emerson Network Power Connectivity Solutions has a wide range of cable assemblies and connectors suited for RF, Microwave and Fiber Optic signal transmission. Connectivity Solutions is a vertically integrated supplier of custom, fixed length and semi-rigid cable assemblies from DC to 50 GHz. Our product lines deliver custom-engineered products and solutions to satisfy the most demanding and complex requirements.

AIM-Cambridge

Connectivity Solutions



Aim-Cambridge has a universal line of products that offer cost effective, high quality solutions for connectivity. Our connectors are available in BNC, Type N, F Type, RCA, UHF, Mini-UHF, TNC, D-Sub and Modular Plugs for Data/Telecom applications. In addition, we stock a wide variety of cables for A/V, SATV, CATV, computer and LAN applications, as well as a complete line of termination tools and structured cabling products. AIM-Cambridge promises that its product will provide you with unmatched consistency, quality, reliability and ease of use.

Johnson

Connectivity Solutions



Johnson designs and manufactures an industry leading line of RF coaxial connectors and adapters, which are available in both 50 and 75 ohm versions. Johnson connectors are designed to provide the highest quality data transmission for audio, video and data applications. The Johnson line of products can address frequency ranges from DC to 46GHz and all sizes from Ultra-miniature interfaces (UMC), Micro-miniature, (MCX, MMCX, SMP), Subminiature (SMA, SMB, SMK, kwiQMate™), Medium connectors (Type N connectors) through to large connectors (DIN7/16). The breadth of products available within the Johnson range includes board and cable mount connectors as well as semi-rigid, conformable, and flexible RF coaxial cables.

Midwest Microwave

Connectivity Solutions



Midwest Microwave manufactures passive coaxial microwave components that are known for their precision performance and high quality that meets the precise requirements of the RF/Microwave industry. Our broad product portfolio includes: Attenuators, Precision Adapters, Terminations, DC Blocks, Power Dividers, Couplers, Equalizers, Phase Shifters, Connectors, Custom Cable Assemblies and Test Cables that are designed and manufactured for both military and commercial applications.

Midwest also offers a wide variety of Qualified Product List (QPL) approved products in the M3933, M39030 and M39012 series, as well as many DESC/DSCC approved models.

Semflex

Connectivity Solutions



Semflex designs and manufactures low loss, flexible, microwave coaxial cable and custom cable assemblies for the military/aerospace, commercial OEM and test instrumentation markets. Semflex offers cables ranging from DC to 50 GHz, available with ultra low insertion loss, power ratings up to 21 KW, and available with all popular connectors.

Stratos

Connectivity Solutions



Stratos optical connectivity products is globally recognized as highly reliable, cost-effective, and provides optical connectivity solutions that are virtually immune to dust, mud, oil, water, and other contaminants.

Our expanded beam connectivity products are ideal for harsh environment applications in the broadcast, industrial, petrochemical and military/aerospace markets where high reliability, low maintenance and quick serviceability are critical requirements. Our optical active products are used mainly in military, aerospace and industrial markets where high speed/high reliable performance is mission critical. The active product line includes optical transceivers, optical media converters and custom devices tailored to your application.

Trompeter

Connectivity Solutions



Trompeter is recognized as a global leader in delivering best in class RF connectivity products. The Trompeter line of patch jacks, RF connectors, cable assemblies, HDTV digital technology and DS3 connectivity solutions is unrivalled. Our mission is to provide products that continually deliver the highest quality signal integrity for the most demanding applications in Telecom, Central Office, Broadcast, Military Aerospace, and Instrumentation markets worldwide. Our extensive line of cost-effective products are rigorously designed and tested to provide the critically engineered solutions necessary to enhance the end-user's overall experience.

Vitelec

Connectivity Solutions



Vitelec provides a comprehensive range of RF coaxial interconnect products and cable assemblies. The company has a long established reputation for offering quality and innovation with a wide range of both standard and custom designed products for the electronic and communication industries.

Attenuators

General Information.....	4
Definition of Parameters	5
2.9mm DC – 40 GHz.....	6
SMA Subminiature “MINIPAD”	7
SMA Miniature Type	11
SMA Ultraminiature Type	13
SMA Flanged Miniature “MINIPAD”	14
3.5mm High Performance.....	15
SMA Medium Power Types	16
7mm Precision Types.....	19
Type N.....	20
Type N – Medium Power.....	21
TNC Type.....	24
TNC Type – Medium Power	25
BNC Type	26
SSMA Type	27
SMB & SMC Type	28
Calibrated Sets.....	29
Adapter Pads.....	30

3 Attenuators

31 Terminations

58 DC Blocks

61 Couplers

73 Power Dividers

81 Equalizers

85 Phase Shifters

87 Between Series Adapters

116 In-Series Adapters

127 Connectors

177 QPL Approved Products & Tools for Assembly

200 Appendix

209 Index

While every precaution has been taken to ensure accuracy and completeness herein, Emerson Network Power Connectivity Solutions assumes no responsibility, and disclaims all liability for damages resulting from use of this information or for any errors or omissions. Specifications subject to change without notice.

General Information

- MIL-DTL-3933 Qualified (QPL) Parts
- DC - 4, DC - 8, DC - 12.4, DC - 18, DC - 26 GHz, and DC - 40 GHz Performance
- Small Size, Light Weight, Rugged Construction
- Average Power up to 20 Watts
- SMA, BMA, N, TNC, BNC, SC, 2.9mm, 3.5mm, and 7mm Connector Configurations
- Designed to Meet Military and Space Environmental Specs, see appendix for details

Attenuators are passive components designed for the purpose of reducing the input power in a matched transmission line system by a predictable amount on a linear basis. Midwest Microwave offers this complete product line of fixed coaxial attenuators, ruggedly designed for system or laboratory test use. These units exhibit low VSWR and high accuracy attenuation performance over the temperature range of -55°C to $+125^{\circ}\text{C}$ and meet the environmental requirements as outlined in the appendix. Medium power attenuators with average power levels of up to 20 Watts are available in up to 30 dB levels in .5 dB increments providing broadband performance and low frequency sensitivity while exhibiting very stable operation over temperature extremes. Standard catalog units are available off the shelf for immediate delivery and special units can be custom designed by Midwest's engineering staff to accommodate unique system needs.



All Midwest Attenuators are completely manufactured in-house and are 100% tested to insure only the highest quality performance whether for military or space use or for commercial applications.

Typical Fixed Attenuator Performance Characteristics

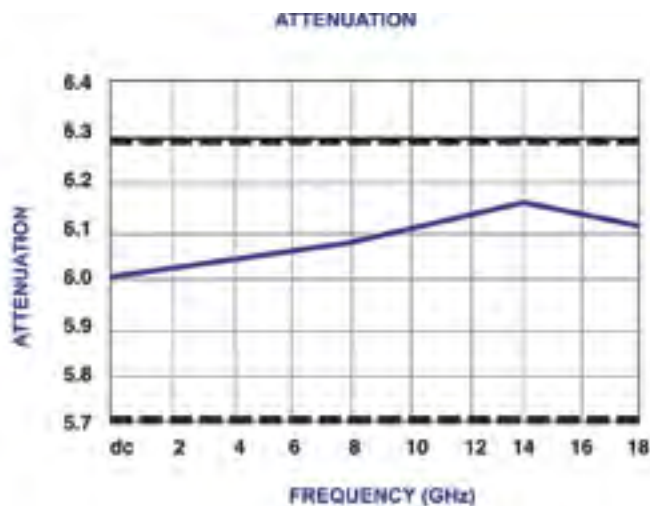
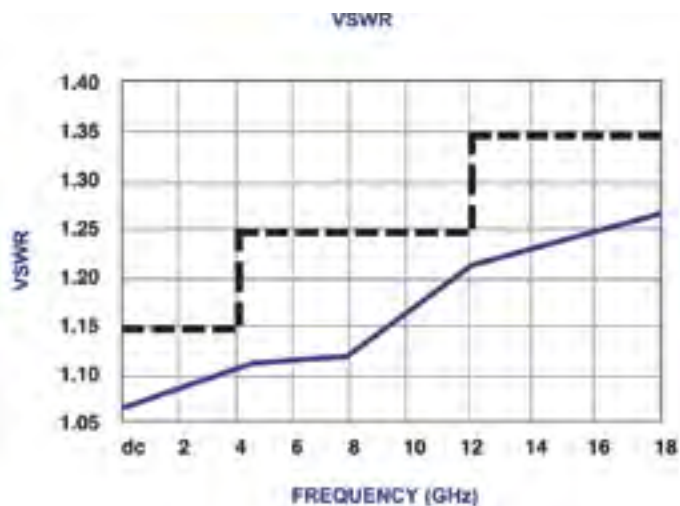

Attenuation

The technical term is most often used in connection with loss or insertion loss in a transmission line. Insertion loss is a combination of two types of losses; impedance mismatch loss (reflective) and attenuation loss (dissipative). Mismatch loss is the ratio of power that would be absorbed by a unit or device under test, if it were perfectly impedance matched, to the actual power absorbed by the device. Attenuation is the ratio of power into a component to the power out under impedance matched conditions, and represents the actual power dissipated within the component. Thereby, Insertion loss is the ratio of the power delivered to a matched load by a matched generator before and after the insertion of a component into the transmission line. When a component is perfectly matched to the transmission line and to the load, the mismatch loss is zero and the insertion loss is the same as the attenuation.

Average Power

The maximum average (cw) power is the maximum input power specified and applied for one hour minimum at the specified temperature of 25° C with the output terminated in a matched impedance such that the specified properties of the attenuator will not be altered or changed after the unit is returned to ambient temperature at a power level that is 20 dB below the maximum specified input power. If the attenuator is operated at higher temperatures then it is necessary to derate the power rating accordingly. The derating curve and specifications shown below describes this specifically.

Peak Power

The maximum peak power at a pulse width or duty cycle of 5 microseconds together with the average power when applied for a minimum period of one hour with the output terminated with a matched load will not damage or permanently alter the specified properties of the attenuator.

Temperature Coefficient

The maximum change of insertion loss in dB per °C from 20° C over the maximum operating temperature range. To obtain the change in insertion loss, multiply the temperature coefficient by the temperature change and then by the value in dB of the attenuator.

Custom Design Availability

In addition to the wide variety of standard model attenuators available on an off the shelf basis, Midwest Microwave retains an extensive engineering staff to accommodate your special requirements. A complete in-house design and manufacturing facility is provided including all testing and documentation for high reliability aerospace applications.

- Frequency applications that are extended
- Attenuation values in .5 dB increments
- Higher power requirements
- High performance, narrow bandwidth applications
- Connector interfaces and mounting requirements that are extraordinary

Temperature Specifications

Operating Temperature Range: -55° C to +125° C

Temperature Coefficient: 1/10,000 dB /dB/ °C

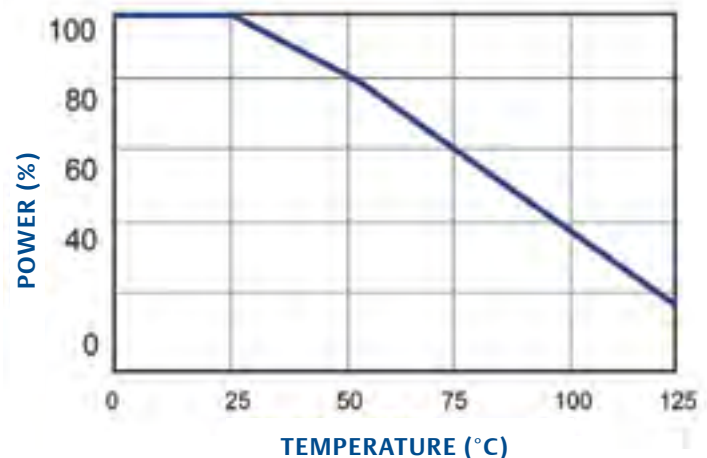

2.9mm DC - 40.0 GHz

2.9mm DC - 40.0 GHz

Midwest Microwave's 2.9mm subminiature series of fixed coaxial attenuators provide temperature stable, ruggedly built, precision performance in a compact lightweight package size.



Specifications		
Series	ATT-0640	
Frequency, (GHz)	DC - 40	
Attenuation Accuracy, (dB):	Attenuator Value	Tolerance (max)
	3 & 6 (DC - 18 GHz)	± 0.5
	3 & 6 (18-40 GHz)	± 0.8
	10 & 20 (DC - 18 GHz)	± 0.6
	10 & 20 (18-40 GHz)	± 1.0
VSWR table, (max.):	Freq. (GHz)	VSWR
	DC - 18.0	1.3
	18.0-40.0	1.4
Average Power*, (W):	1	
Operating Temperature, (°C)	-65 to +125	
Finish:	Passivated Stainless Steel	

* Rated @25°C, derated linearly to 0.5W @ 125°C

DC - 40 GHz 640 Series		
Male/Female	Female/Female	Male/Male
ATT-0640-XX-29M-02	ATT-640F-XX-29M-02	ATT-640M-XX-29M-02

XX = Attenuation Value : Select 3, 6, 10, 20 dB
 For Attenuators with Hex Body substitute HEX for 29M in Model No.

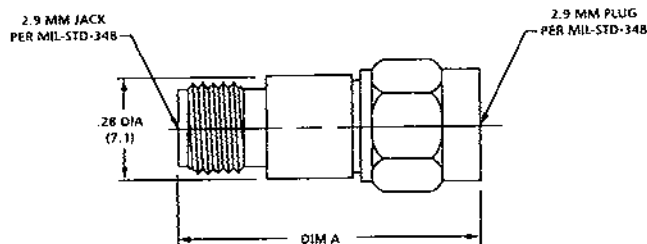

Attenuation Value	Length A
3, 6, 10 & 20 dB	0.86 (21.8)

DC - 26.5 GHz High Performance

- DC - 2, DC - 8, DC - 12.4, and DC - 18 GHz Units
- Rugged Stainless Steel Construction
- Any Male/Female Combinations
- Economical Alternatives

Midwest Microwave's SMA subminiature series of fixed coaxial attenuators provide temperature stable, ruggedly built, precision performance in a compact lightweight package size. Attenuation values up through 30 dB in 1 dB increments are available with any of the units described and with any combination of female or male SMA connectors.



Specifications					
Series	ATT-0298	ATT-0290	ATT-0291	ATT-0292	ATT-0294
Frequency, (GHz)	DC - 26.5	DC - 18.0	DC - 12.4	DC - 8.0	DC - 2.0
Attenuation Accuracy, (dB):	Attenuator Value		Tolerance (max)		
	1-6		± 0.5		
	7-20		± 0.7		
	21-30		± 1.0		
VSWR formula, (max.):	1.07 + 0.015(f GHz)				
VSWR table, (max.):	Freq. (GHz)		VSWR		
	DC - 8.0		1.19		
	8.0-18.0		1.34		
	18.0-26.5		1.47		
Average Power*, (W):	2				
Peak Power, (W):	200				
Operating Temperature, (°C)	-65 to +125				
Finish:	Passivated Stainless Steel				

* Rated @25°C, derated linearly to 0.5W @ 125°C

DC - 26.5 GHz 298 Series		
Male/Female	Female/Female	Male/Male
ATT-0298-XX-SMA-02	ATT-298F-XX-SMA-02	ATT-298M-XX-SMA-02

XX = Attenuation Value : Select 01-30 dB in 1 dB increments (.5 dB increments available)
HIGH PERFORMANCE

DC - 18.0 GHz 290 Series		
Male/Female	Female/Female	Male/Male
ATT-0290-XX-SMA-02	ATT-290F-XX-SMA-02	ATT-290M-XX-SMA-02

XX = Attenuation Value : Select 01-30 dB in 1 dB increments (.5 dB increments available)
HIGH PERFORMANCE

DC - 12.4 GHz 291 Series		
Male/Female	Female/Female	Male/Male
ATT-0291-XX-SMA-02	ATT-291F-XX-SMA-02	ATT-291M-XX-SMA-02

XX = Attenuation Value : Select 01-30 dB in 1 dB increments (.5 dB increments available)
HIGH PERFORMANCE

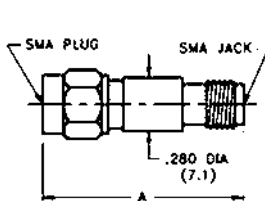

Attenuation Value	Length A
1-12 dB	0.86 (21.8)
13-30 dB	1.02 (25.9)

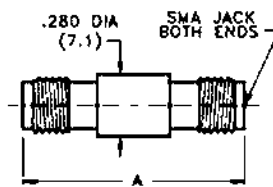

Attenuation Value	Length A
1-12 dB	0.90 (22.9)
13-30 dB	1.02 (25.9)

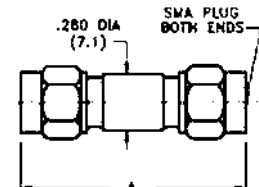

Attenuation Value	Length A
1-12 dB	0.98 (24.9)
13-30 dB	1.12 (28.4)

SMA Subminiature “MINIPAD”

Continued from previous page

DC - 8.0 GHz 292 Series		
Male/Female	Female/Female	Male/Male
ATT-0292-XX-SMA-02	ATT-292F-XX-SMA-02	ATT-292M-XX-SMA-02

XX = Attenuation Value : Select 01-30 dB in 1 dB increments (.5 dB increments available)

HIGH PERFORMANCE

DC - 2.0 GHz 294 Series		
Male/Female	Female/Female	Male/Male
ATT-0294-XX-SMA-02	ATT-294F-XX-SMA-02	ATT-294M-XX-SMA-02

XX = Attenuation Value : Select 01-30 dB in 1 dB increments (.5 dB increments available)

HIGH PERFORMANCE

Low VSWR Version

Specifications		
Series	ATT-451	
Frequency, (GHz)	DC - 18.0	
Attenuation Accuracy, (dB):	Attenuator Value	Tolerance (max)
	1-6	± 0.3
	7-20	± 0.5
	21-30	± 1.0
	31-40	± 1.5
VSWR table, (max.):	Freq. (GHz)	VSWR
	DC-4.0	1.12
	4.0-8.0	1.15
	8.0-18.0	1.2
Average Power*, (W):	2	
Peak Power, (W):	200	
Operating Temperature, (°C)	-65 to +125	
Finish:	Passivated Stainless Steel	

* Rated @25°C, derated linearly to 0.5W @ 125°C



DC - 18.0 GHz 451 Series		
Male/Female	Female/Female	Male/Male
ATT-0451-XX-SMA-02	ATT-0451F-XX-SMA-02	ATT-451M-XX-SMA-02

XX = Attenuation Value : Select 01-30 dB in 1 dB increments (.5 dB increments available)

LOW VSWR

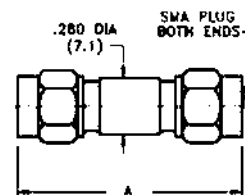
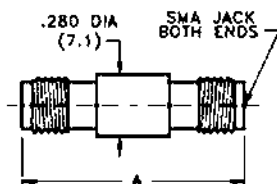
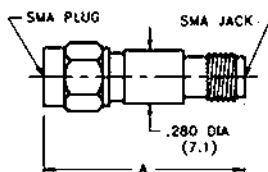

Attenuation Value	Length A
1-12 dB	0.86 (21.8)
13-30 dB	1.02 (25.9)

Attenuation Value	Length A
1-12 dB	0.90 (22.9)
13-30 dB	1.03 (25.9)

Attenuation Value	Length A
1-12 dB	0.98 (24.9)
13-30 dB	1.12 (28.4)



Hex Body Types - High Performance

Specifications					
Series, Hex	ATT-0298	ATT-0290	ATT-0291	ATT-0292	ATT-0294
Frequency, (GHz)	DC - 26.5	DC - 18.0	DC - 12.4	DC - 8.0	DC - 2.0
Attenuation Accuracy, (dB):	Attenuator Value		Tolerance (max)		
	1-6		± 0.5		
	7-20		± 0.7		
	21-30		± 1.0		
VSWR formula, (max.):	$1.07 + 0.015(f \text{ GHz})$				
VSWR table, (max.):	Freq. (GHz)		VSWR		
	DC-8.0		1.19		
	8.0-18.0		1.34		
	18.0-26.5		1.47		
Average Power*, (W):	2				
Peak Power, (W):	200				
Operating Temperature, (°C)	-65 to +125				
Finish:	Passivated Stainless Steel				

* Rated @25°C, derated linearly to 0.5W @ 125°C

DC - 26.5 GHz Hex Body 298 HEX Series		
Male/Female	Female/Female	Male/Male
ATT-0298-XX-HEX-02	ATT-298F-XX-HEX-02	ATT-298M-XX-HEX-02

XX = Attenuation Value : Select 01-30 dB in 1 dB increments (.5 dB increments available) HIGH PERFORMANCE

DC - 18.0 GHz Hex Body 290 HEX Series		
Male/Female	Female/Female	Male/Male
ATT-0290-XX-HEX-02	ATT-0290F-XX-HEX-02	ATT-290M-XX-HEX-02

XX = Attenuation Value : Select 01-30 dB in 1 dB increments (.5 dB increments available) HIGH PERFORMANCE

DC - 12.4 GHz Hex Body 291 HEX Series		
Male/Female	Female/Female	Male/Male
ATT-0291-XX-HEX-02	ATT-0291F-XX-HEX-02	ATT-291M-XX-HEX-02

XX = Attenuation Value : Select 01-30 dB in 1 dB increments (.5 dB increments available) HIGH PERFORMANCE

DC - 8.0 GHz Hex Body 292 HEX Series		
Male/Female	Female/Female	Male/Male
ATT-0292-XX-HEX-02	ATT-0292F-XX-HEX-02	ATT-292M-XX-HEX-02

XX = Attenuation Value : Select 01-30 dB in 1 dB increments (.5 dB increments available) HIGH PERFORMANCE

DC - 2.0 GHz Hex Body 294 HEX Series		
Male/ Female	Female/Female	Male/ Male
ATT-0294-XX-HEX-02	ATT-0294F-XX-HEX-02	ATT-294M-XX-HEX-02

XX = Attenuation Value : Select 01-30 dB in 1 dB increments (.5 dB increments available) HIGH PERFORMANCE

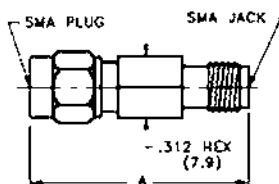

Attenuation Value	Length A
1-12 dB	0.86 (21.8)
13-30 dB	1.02 (25.9)

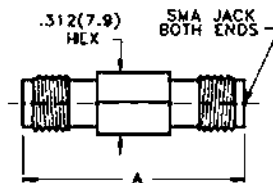

Attenuation Value	Length A
1-12 dB	0.90 (22.9)
13-30 dB	1.03 (25.9)

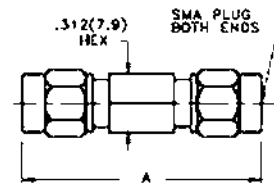

Attenuation Value	Length A
1-12 dB	0.98 (24.9)
13-30 dB	1.12 (28.4)

SMA Subminiature "MINIPAD"

Round Body - Economical Version

Specifications		
Series	ATT-444	
Frequency, (GHz)	DC - 18.0	
Attenuation Accuracy, (dB):	Attenuator Value	Tolerance (max)
	1-4	± 0.75
	5-8	± 1.0
	9-12	± 1.25
	13-20	± 1.5
VSWR table, (max.):	Freq. (GHz)	VSWR
	DC - 4.0	1.25
	4.0-12.4	1.45
	12.4-18.0	1.65
Average Power*, (W):	2	
Operating Temperature, (°C)	-65 to +125	
Finish:	Passivated Stainless Steel	



* Rated @25°C, derated linearly to 0.5W @ 125°C

DC - 18.0 GHz 444 Series		
Male/Female	Female/Female	Male/Male
ATT-0444-XX-SMA-02	ATT-444F-XX-SMA-02	ATT-444M-XX-SMA-02

XX = Attenuation Value : Select 01-30 dB in 1 dB increments

ECONOMICAL

Note: Economical Models are available in Hex Body - Designate by substituting "HEX" for SMA in Model No.

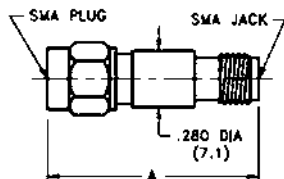

Attenuation Value	Length A
1-12 dB	0.86 (21.8)
13-30 dB	1.02 (25.9)

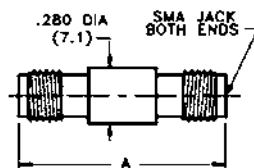

Attenuation Value	Length A
1-12 dB	0.90 (22.9)
13-30 dB	1.03 (25.9)

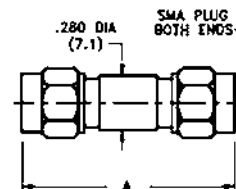

Attenuation Value	Length A
1-12 dB	0.98 (24.9)
13-30 dB	1.12 (28.4)

DC - 18.0 GHz High Performance

- DC - 4.0 and DC - 12.4 Units
- 0 - 60 dB Attenuation Values
- Rugged Stainless Steel Construction
- Any Male/Female Combinations
- Economical Alternatives

Midwest Microwave's SMA miniature series of fixed coaxial attenuators provide temperature stable, ruggedly built, precision performance in a small light weight package size. Attenuation values up through 60 dB in 1 dB increments are available with any of the units described and with any combination of female or male SMA connectors.



Specifications			
Series	ATT-0263	ATT-0205	ATT-0238
Frequency, (GHz)	DC - 18.0	DC - 12.4	DC - 4.0
Attenuation Accuracy, (dB):	Attenuator Value	Tolerance (max)	
	1-10	± 0.3	
	11-20	± 0.5	
	21-40	± 1.0	
	41-60	± 1.5	
VSWR formula, (max.):	1.07 + 0.015(f GHz)		
VSWR table, (max.):	Freq. (GHz)	VSWR	
	DC - 4.0	1.13	
	4.0-8.4	1.19	
	8.0-18.0	1.34	
Average Power*, (W):	2		
Operating Temperature, (°C)	-65 to +125		
Finish:	Passivated Stainless Steel		

* Rated @25°C, derated linearly to 0.5W @ 125°C

DC - 18.0 GHz 263 Series		
Male/Female	Female/Female	Male/Male
ATT-0263-XX-SMA-02	ATT-263F-XX-SMA-02	ATT-263M-XX-SMA-02

XX = Attenuation Value: Select 01-30 dB in 1 dB increments (.5 dB increments available)
HIGH PERFORMANCE

DC - 12.4 GHz 205 Series		
Male/Female	Female/Female	Male/Male
ATT-0205-XX-SMA-02	ATT-205F-XX-SMA-02	ATT-205M-XX-SMA-02

XX = Attenuation Value: Select 01-30 dB in 1 dB increments (.5 dB increments available)
HIGH PERFORMANCE

DC - 4.0 GHz 238 Series		
Male/Female	Female/Female	Male/Male
ATT-0238-XX-SMA-02	ATT-238F-XX-SMA-02	ATT-238M-XX-SMA-02

XX = Attenuation Value : Select 01-30 dB in 1 dB increments (.5 dB increments available)
HIGH PERFORMANCE

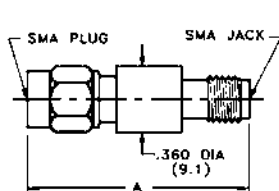

Attenuation Value	Length A
1-20 dB	1.20 (30.5)
21-60 dB	1.49 (37.8)

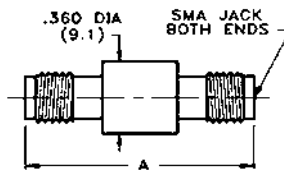

Attenuation Value	Length A
1-20 dB	1.07 (27.2)
21-60 dB	1.36 (34.5)

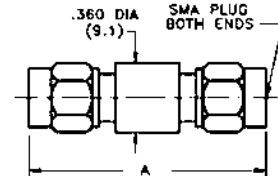

Attenuation Value	Length A
1-30 dB	1.33 (33.8)
31-60 dB	1.44 (36.6)

SMA Miniature Type

Economical Version

Specifications		
Series	ATT-0333	
Frequency, (GHz)	DC - 18.0	
Attenuation Accuracy, (dB):	Attenuator Value	Tolerance (max)
	0.5-4	± 0.75
	4.5-8	± 1.0
	8.5-12	± 1.25
	12.5-20	± 1.5
VSWR table, (max.):	Freq. (GHz)	VSWR
	DC - 4.0	1.25
	4.0-12.4	1.45
	12.4-18.0	1.65
Average Power*, (W):	2	
Operating Temperature, (°C)	-65 to +125	
Finish:	Passivated Stainless Steel	



* Rated @25°C, derated linearly to 0.5W @ 125°C

DC - 18.0 GHz 333 Series		
Male/Female	Female/Female	Male/Male
ATT-0333-XX-SMA-02	ATT-333F-XX-SMA-02	ATT-333M-XX-SMA-02

XX = Attenuation Value : Select 01-30 dB in 1 dB increments
ECONOMICAL

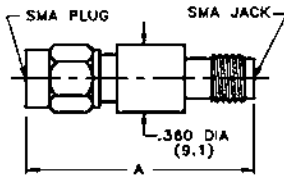

Attenuation Value	Length A
1-20 dB	1.20 (30.5)
21-60 dB	1.30 (33.0)

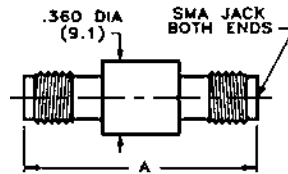

Attenuation Value	Length A
1-20 dB	1.07 (27.2)
21-60 dB	1.36 (34.5)

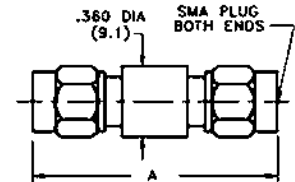

Attenuation Value	Length A
1-20 dB	1.33 (33.8)
21-60 dB	1.62 (36.6)

DC - 18.0 GHz High Performance

- DC - 8 and DC - 12.4 Units
- 0 - 30 dB Attenuation Values
- Rugged Stainless Steel Construction
- Any Male / Female Combinations
- Small Size – Light Weight



Midwest Microwave's SMA Ultraminiature series of fixed coaxial attenuators provide temperature stable, ruggedly built, precision performance in a very small light weight package size. Attenuation values up through 30 dB in 1 dB increments are available with any of the units described and with any combination of female or male SMA connectors.

Specifications			
Series	ATT-0275	ATT-0276	ATT-0277
Frequency, (GHz)	DC - 18.0	DC - 12.4	DC - 8.0
Attenuation Accuracy, (dB):	Attenuator Value	Tolerance (max)	
	1-6	± 0.3	
	7-20	± 0.5	
	21-30	± 1.0	
VSWR formula, (max.):	1.07 + 0.015(f GHz)		
VSWR table, (max.):	Freq. (GHz)	VSWR	
	DC - 8.0	1.19	
	8.0-12.4	1.25	
	12.4-18.0	1.34	
Average Power*, (W):	2		
Operating Temperature, (°C)	-65 to +125		
Finish:	Passivated Stainless Steel		

* Rated @25°C, derated linearly to 0.5W @ 125°C

DC - 18.0 GHz 275 Series		
Male/Female	Female/Female	Male/Male
ATT-0275-XX-SMA-02	ATT-275F-XX-SMA-02	ATT-275M-XX-SMA-02

XX = Attenuation Value: Select 01-30 dB in 1 dB increments (.5 dB increments available)
HIGH PERFORMANCE

DC - 12.4 GHz 276 Series		
Male/Female	Female/Female	Male/Male
ATT-0276-XX-SMA-02	ATT-276F-XX-SMA-02	ATT-276M-XX-SMA-02

XX = Attenuation Value: Select 01-30 dB in 1 dB increments (.5 dB increments available)
HIGH PERFORMANCE

DC - 8.0 GHz 277 Series		
Male/Female	Female/Female	Male/Male
ATT-0277-XX-SMA-02	ATT-277F-XX-SMA-02	ATT-277M-XX-SMA-02

XX = Attenuation Value: Select 01-30 dB in 1 dB increments (.5 dB increments available)
HIGH PERFORMANCE

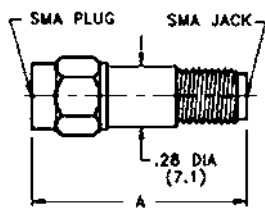

Attenuation Value	Length A
1-12 dB	0.750 (19.0)
13-30 dB	0.875 (22.2)

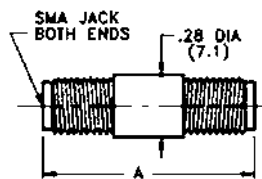

Attenuation Value	Length A
1-12 dB	0.700 (17.8)
13-30 dB	0.825 (21.0)

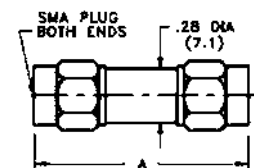

Attenuation Value	Length A
1-12 dB	0.875 (22.2)
13-30 dB	1.00 (25.4)

SMA Flanged Miniature “MINIPAD”

Flange Mount Types – High Performance

- Extended Frequency Performance
- Any Male / Female Connector Configuration
- Rugged Stainless Steel Construction

Midwest Microwave’s SMA subminiature series of fixed coaxial attenuators (MINIPAD®) provide temperature stable, ruggedly built, precision performance in a compact lightweight package size. Attenuation values up through 30 dB in 1 dB increments are available with any of the units described and with any combination of female or male SMA connectors.



Specifications		
Series	ATT-0523	
Frequency, (GHz)	DC - 18.0	
Attenuation Accuracy, (dB):	Attenuator Value	Tolerance (max)
	1-6	± 0.3
	7-20	± 0.5
	21-30	± 1.0
VSWR formula, (max.):	1.07 + 0.015 (f GHz)	
VSWR table, (max.):	Freq. (GHz)	VSWR
	DC - 8.0	1.19
	8.0-12.4	1.25
	12.4-18.0	1.34
Average Power*, (W):	2	
Operating Temperature, (°C)	-65 to +125	
Finish:	Passivated Stainless Steel	

* Rated @25°C, derated linearly to 0.5W @ 125°C

DC - 18.0 GHz Flange Mount 523 Series		
Male/Female	Female/Female	Male/Male
ATT-0523-XX-SMA-02	ATT-523F-XX-SMA-02	ATT-523M-XX-SMA-02

XX = Attenuation Value

Select 01 - 30 dB in 1 dB increments.

For all other dB values in the range of 0 - 60 dB in 1 and 0.5 dB increments, please contact customer service for pricing and availability.

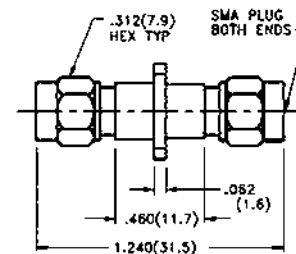
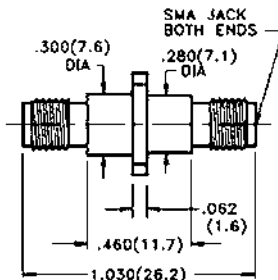
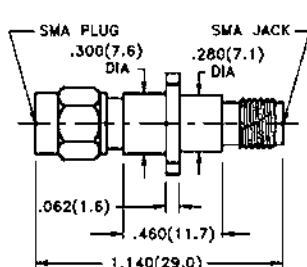

DC - 26.5 GHz 3.5mm High Performance



- Extended Frequency Performance
- 0 - 30 dB Attenuation Values
- 3.5 mm Precision Connectors (Mates with SMA)
- Small Size – Light Weight
- Any Male / Female Connector Configurations
- Rugged Stainless Steel Construction

Midwest Microwave’s 3.5 mm subminiature series of precision fixed coaxial attenuators provide extended frequency operation of up to 26.5 GHz when mated with connector interfaces of the same family. These temperature stable, ruggedly built, precision attenuators allow high performance in a very small light weight package size Attenuation values up through 30 dB in 1 dB increments are available with any combination of female or male 3.5mm connectors.

Specifications		
Series	ATT-0550	
Frequency, (GHz)	DC - 26.5	
Attenuation Accuracy, (dB):	Attenuator Value	Tolerance (max)
	0-6.5	± 0.5
	7-20	± 0.7
	21-30	± 1.5
VSWR table, (max.):	Freq. (GHz)	VSWR
	DC - 8.0	1.19
	8.0-18.0	1.34
	18.0-26.4	1.47
Average Power*, (W):	2	
Operating Temperature, (°C)	-65 to +125	
Finish:	Passivated Stainless Steel	

* Rated @25°C, derated linearly to 0.5W @ 125°C

DC - 26.5 GHz 550 Series		
Male/Female	Female/Female	Male/Male
ATT-0550-XX-35M-02	ATT-550F-XX-35M-02	ATT-550M-XX-35M-02

XX = Attenuation Value

Standard dB values are 01-10, 15, 20 & 30.

For all other dB values in the range of 0 - 60 dB in 1 and 0.5 dB increments, please contact customer service for pricing and availability.

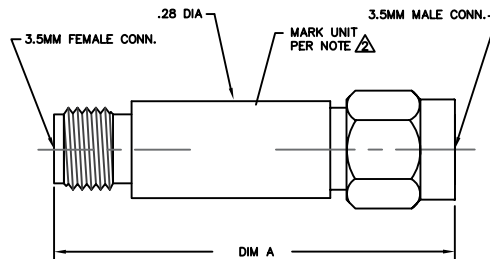

Attenuation Value	Length A
0-29 dB	1.35 (34.5)
30-40 dB	1.47 (37.3)

SMA Medium Power Types

DC – 18.0 GHz High Performance, 5W

- DC - 18.0 GHz Performance
- Rugged Stainless Steel Interface Construction
- Any Male / Female Combinations
- Low VSWR – High Performance

Midwest Microwave's SMA series of medium power fixed coaxial attenuators provide temperature stable, ruggedly built, precision performance in light weight reasonably sized packages. Attenuation values range through 40 dB in 1 dB increments and are available with any combination of female or male SMA connectors.



Specifications		
Series	ATT-0473	ATT-0475
Frequency, (GHz)	DC - 18.0	DC - 6.0
Attenuation Accuracy, (dB):	Attenuator Value	Tolerance (max)
	1-10	± 0.3
	11-20	± 0.5
	21-30	± 0.7
	31-40	± 1.0
VSWR table, (max.):	Freq. (GHz)	VSWR
	DC - 4.0	1.1
	4.0-8.0	1.15
	8.0-12.4	1.2
	12.4-18.0	1.3
Average Power*, (W):	5	
Operating Temperature, (°C)	-65 to +125	
Finish Body:	Black Anodized Aluminum	
Finish Connectors:	Passivated Stainless Steel	

* Rated @25°C, derated linearly to 1W @ 125°C

DC - 18.0 GHz 473 Series		
Male/Female	Female/Female	Male/Male
ATT-0473-XX-SMA-07	ATT-473F-XX-SMA-07	ATT-473M-XX-SMA-07

XX = Attenuation Value: Select 01-40 in 1 dB increments
 Standard dB values are 01-10, 15, 20 & 30. For all other dB values in the range of 1- 40 dB in 1 and 0.5 dB increments, please contact customer service for pricing and availability.

DC - 6.0 GHz 475 Series		
Male/Female	Female/Female	Male/Male
ATT-0475-XX-SMA-07	ATT-475F-XX-SMA-07	ATT-475M-XX-SMA-07

XX = Attenuation Value: Select 01-20 in 1 dB increments
 Standard dB values are 01-10, 15, 20 & 30. For all other dB values in the range of 1- 40 dB in 1 and 0.5 dB increments, please contact customer service for pricing and availability.

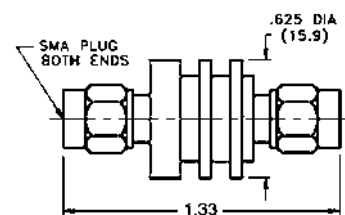
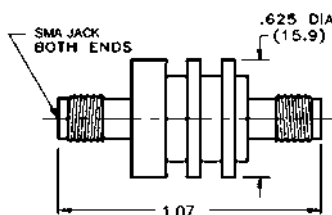
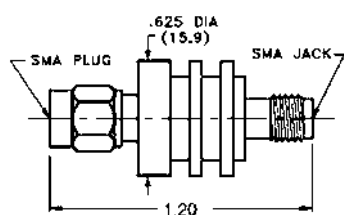

DC – 18.0 GHz High Performance, 10W

Specifications		
Series	ATT-0303	ATT-0472
Frequency, (GHz)	DC - 18.0	DC - 6.0
Attenuation Accuracy, (dB):	Attenuator Value	Tolerance (max)
	1-10	± 0.5
	11-20	± 0.7
	21-40	± 1.0
VSWR table, (max.):	Freq. (GHz)	VSWR
	DC - 18.0	1.5
Average Power*, (W):	10	
Peak Power, (W):	50	
Operating Temperature, (°C)	-65 to +125	
Finish Body:	Black Anodized Aluminum	
Finish Connectors:	Passivated Stainless Steel	

* Rated @40°C, derated linearly to 0.5W @ 125°C



DC - 18.0 GHz 303 Series		
Male/Female	Female/Female	Male/Male
ATT-0303-XX-SMA-07	ATT-303F-XX-SMA-07	ATT-303M-XX-SMA-07

XX = Attenuation Value: Select 01-40 in 1 dB increments

Standard dB values are 01-10, 15, 20 & 30. For all other dB values in the range of 1- 40 dB in 1 and 0.5 dB increments, please contact customer service for pricing and availability.

DC - 6.0 GHz 472 Series		
Male/Female	Female/Female	Male/Male
ATT-0472-XX-SMA-07	ATT-472F-XX-SMA-07	ATT-472M-XX-SMA-07

XX = Attenuation Value: Select 01-40 in 1 dB increments

Standard dB values are 01-10, 15, 20 & 30. For all other dB values in the range of 1- 40 dB in 1 and 0.5 dB increments, please contact customer service for pricing and availability.

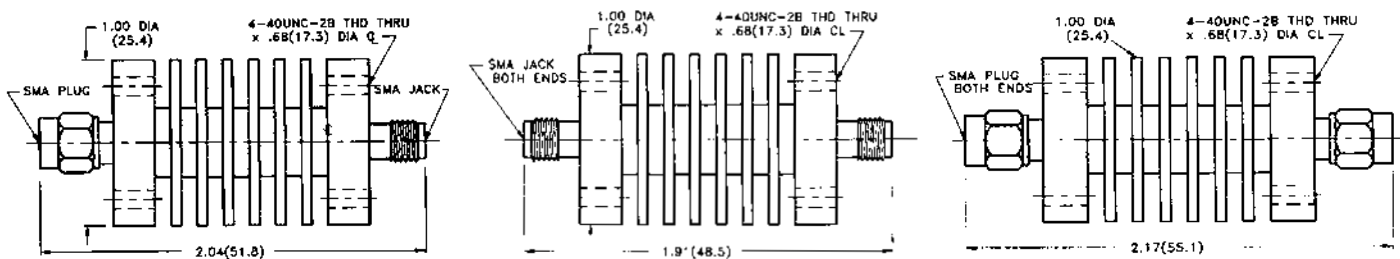

SMA Medium Power Type

DC – 15.0 GHz High Performance, 20W

Specifications		
Series	ATT-0553	ATT-0554
Frequency, (GHz)	DC - 15.0	DC - 6.0
Attenuation Accuracy, (dB):	Attenuator Value	Tolerance (max)
	1-6	± 0.5
	7-10	± 0.75
	11-20	± 1.0
	21-40	± 1.5
VSWR table, (max.):	Freq. (GHz)	VSWR
	DC - 12.4	1.35
	12.4-15.0	1.5
Average Power*, (W):	20	
Peak Power, (W):	500	
Operating Temperature, (°C)	-65 to +125	
Finish Body:	Black Anodized Aluminum	
Finish Connectors:	Passivated Stainless Steel	

* Rated @40°C, derated linearly to 5W @ 125°C



DC - 15.0 GHz 553 Series		
Male/Female	Female/Female	Male/Male
ATT-0553-XX-SMA-07	ATT-553F-XX-SMA-07	ATT-553M-XX-SMA-07

XX = Attenuation Value: Select 01-40 in 1 dB increments
 Standard dB values are 01-10, 15, 20 & 30. For all other dB values in the range of 1- 40 dB in 1 and 0.5 dB increments, please contact customer service for pricing and availability.

DC - 6.0 GHz 554 Series		
Male/Female	Female/Female	Male/Male
ATT-0554-XX-SMA-07	ATT-554F-XX-SMA-07	ATT-554M-XX-SMA-07

XX = Attenuation Value: Select 01-40 in 1 dB increments
 Standard dB values are 01-10, 15, 20 & 30. For all other dB values in the range of 1- 40 dB in 1 and 0.5 dB increments, please contact customer service for pricing and availability.

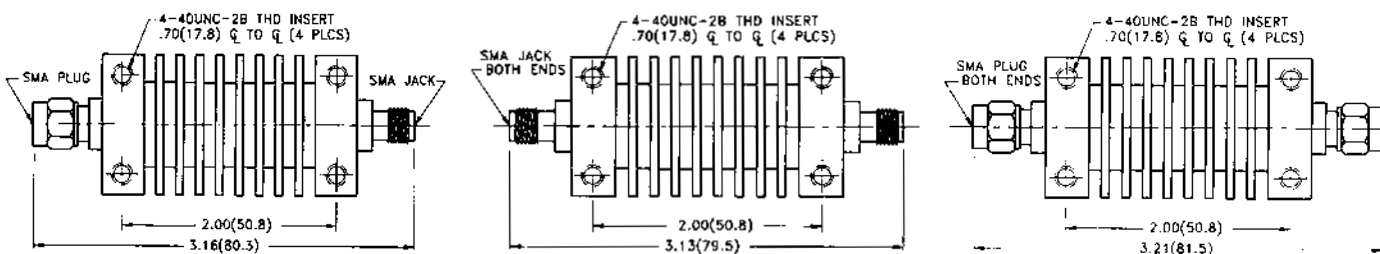



DC – 18.0 GHz 7mm Lab Precision

Specifications				
Series	ATT-0431		ATT-0220	
Frequency, (GHz)	DC - 18.0		DC - 18.0	
Attenuation Accuracy, (dB):	Attenuator Value	Tolerance (max)	Attenuator Value	Tolerance (max)
	3 & 6	± 0.3	1-6	± 0.3
	10 & 20	± 0.5	7-20	± 0.5
			21-40	± 1.0
			41-60	± 1.5
VSWR formula, (max.):	N/A		1.07 + 0.015 (f GHz)	
VSWR table, (max.):	Freq. (GHz)	VSWR	Freq. (GHz)	VSWR
	DC - 4.0	1.12	DC - 8.0	1.19
	4.0-8.0	1.15	8.0-12.4	1.25
	8.0-18.0	1.2	12.4-18.0	1.34
Average Power*, (W):	2		2	
Calibration supplied at, GHz	N/A		4.0, 8.0, 12.0, 18.0	
Operating Temperature, (°C)	-65 to +125		-65 to +125	
Finish Connectors:	Passivated Stainless Steel		Passivated Stainless Steel	

* Rated @40°C, derated linearly to 0.5W @ 125°C

DC - 18.0 GHz 431 Series	
ATT-0431-XX-7MM-02	Low VSWR

XX = Attenuation Value: Select 3, 6, 10 or 20 dB

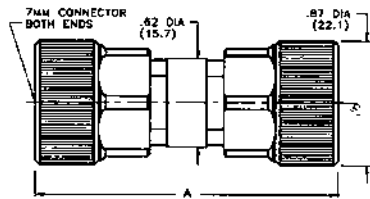

Attenuation Value	Length A
1 - 20 dB	1.83 (46.5)
21-60 dB	2.24 (56.9)

DC - 18.0 GHz 220 Series	
ATT-0220-XX-7MM-02	Broadband Performance

XX = Attenuation Value: Select 1-60 dB in 1 dB increments

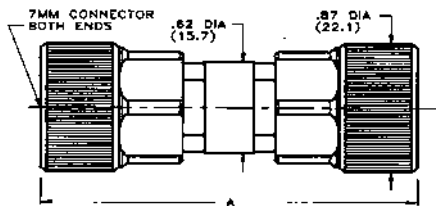

Attenuation Value	Length A
1 - 20 dB	2.19 (55.6)
21-60 dB	2.47 (62.7)

Type N

DC – 18.0 GHz N Type, Lab Precision

Specifications				
Series	ATT-0389		ATT-0219	ATT-0218
Frequency, (GHz)	DC - 18.0		DC - 18.0	DC - 12.4
Attenuation Accuracy, (dB):	Attenuator Value	Tolerance (max)	Attenuator Value	Tolerance (max)
	3 & 6	± 0.3	1-6	± 0.3
	10 & 20	± 0.5	7-20	± 0.5
			21-40	± 1.0
		41-60	± 1.5	
VSWR formula, (max.):	N/A		1.07 + 0.015 (f GHz)	
VSWR table, (max.):	Freq. (GHz)	VSWR	Freq. (GHz)	VSWR
	DC - 4.0	1.12	DC - 8.0	1.19
	4.0-8.0	1.15	8.0-12.4	1.25
	8.0-18.0	1.2	12.4-18.0	1.34
Average Power*, (W):	2		2	
Calibration supplied at, GHz	4.0, 8.0, 12.0, 18.0		N/A	
Operating Temperature, (°C)	-65 to +125		-65 to +125	
Finish Connectors:	Passivated Stainless Steel		Passivated Stainless Steel	



* Rated @40°C, derated linearly to 0.5W @ 125°C

DC - 18.0 GHz 389 Series	
ATT-0389-XX-NNN-02	Low VSWR

XX = Attenuation Value: Select 3, 6, 10 or 20 dB

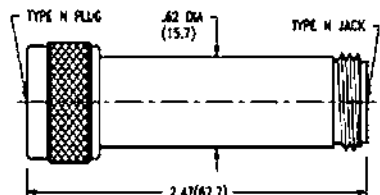

DC - 18.0 GHz 219 Series		
Male/Female	Female/Female	Male/Male
ATT-0219-XX-NNN-02	ATT-219F-XX-NNN-02	ATT-219M-XX-NNN-02

XX = Attenuation Value: Select 01-60 in 1 dB increments
Standard dB values are 01-10, 15, 20 & 30. For all other dB values in the range of 1- 60 dB in 1 and 0.5 dB increments, please contact customer service for pricing and availability.

DC - 12.4 GHz 218 Series		
Male/Female	Female/Female	Male/Male
ATT-0218-XX-NNN-02	ATT-218F-XX-NNN-02	ATT-218M-XX-NNN-02

XX = Attenuation Value: Select 01-60 in 1 dB increments
Standard dB values are 01-10, 15, 20 & 30. For all other dB values in the range of 1- 60 dB in 1 and 0.5 dB increments, please contact customer service for pricing and availability.

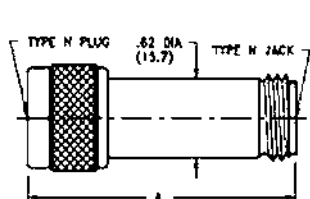

Attenuation Value	Length A
21 - 60 dB	2.05 (52.1)
0 - 20 dB	1.77 (45.0)

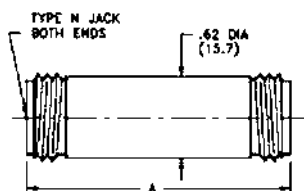

Attenuation Value	Length A
1 - 20 dB	1.77 (45.0)
21-60 dB	2.05 (52.1)

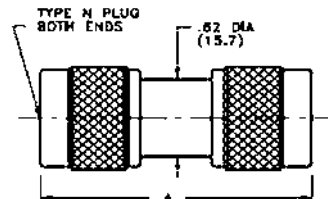

Attenuation Value	Length A
1 - 20 dB	1.74 (44.2)
21-60 dB	2.02 (51.3)

DC – 15.0 GHz, N Type, 5W

Specifications		
Series	ATT-0390	ATT-0391
Frequency, (GHz)	DC - 15.0	DC - 12.4
Attenuation Accuracy, (dB):	Attenuator Value	Tolerance (max)
	1-6	± 0.5
	7-20	± 0.75
	21-40	± 1.0
VSWR formula, (max.):	1.06 + 0.02 (f GHz)	
VSWR table, (max.):	Freq. (GHz)	VSWR
	DC - 12.4	1.3
	12.4-15.0	1.36
Average Power*, (W):	5	
Operating Temperature, (°C)	-65 to +125	
Finish Body:	Black Anodized Aluminum	
Finish Connectors:	Passivated Stainless Steel	

* Rated @40°C, derated linearly to 1W @ 125°C



DC - 15.0 GHz 390 Series		
Male/Female	Female/Female	Male/Male
ATT-0390-XX-NNN-07	ATT-390F-XX-NNN-07	ATT-390M-XX-NNN-07

XX = Attenuation Value: Select 01-40 in 1 dB increments

Standard dB values are 01-10, 15, 20 & 30. For all other dB values in the range of 1- 40 dB in 1 and 0.5 dB increments, please contact customer service for pricing and availability.

DC - 12.4 GHz 391 Series		
Male/Female	Female/Female	Male/Male
ATT-0391-XX-NNN-07	ATT-391F-XX-NNN-07	ATT-391M-XX-NNN-07

XX = Attenuation Value: Select 01-40 in 1 dB increments

Standard dB values are 01-10, 15, 20 & 30. For all other dB values in the range of 1- 40 dB in 1 and 0.5 dB increments, please contact customer service for pricing and availability.

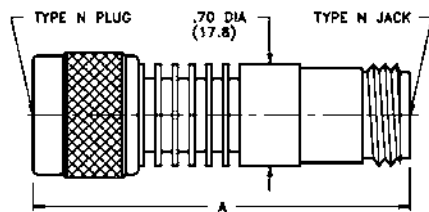

Attenuation Value	Length A
1 - 6 dB	2.38 (60.5)
7 - 40 dB	2.82 (71.6)

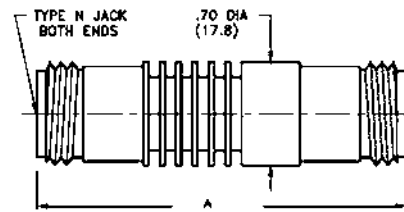

Attenuation Value	Length A
1 - 6 dB	2.32 (59.0)
7 - 40 dB	2.75 (69.9)

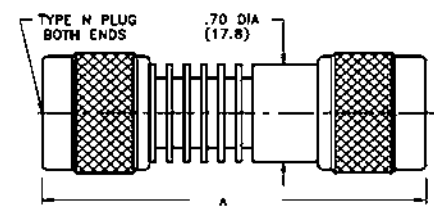

Attenuation Value	Length A
1 - 6 dB	2.48 (53.0)
7 - 40 dB	2.91 (74.0)

Type N – Medium Power

DC – 15.0 GHz, N Type, 10W

Specifications		
Series	ATT-0397	ATT-0392
Frequency, (GHz)	DC - 15.0	DC - 12.4
Attenuation Accuracy, (dB):	Attenuator Value	Tolerance (max)
	1-6	± 0.5
	7-20	± 0.75
	21-40	± 1.0
VSWR formula, (max.):	1.06 + 0.02(f GHz)	
VSWR table, (max.):	Freq. (GHz)	VSWR
	DC - 12.4	1.3
	12.4-15.0	1.36
Average Power*, (W):	10	
Operating Temperature, (°C)	-65 to +125	
Finish Body:	Black Anodized Aluminum	
Finish Connectors:	Passivated Stainless Steel	

* Rated @40°C, derated linearly to 1W @ 125°C



DC - 15.0 GHz 397 Series		
Male/Female	Female/Female	Male/Male
ATT-0397-XX-NNN-07	ATT-397F-XX-NNN-07	ATT-397M-XX-NNN-07

XX = Attenuation Value: Select 01-40 in 1 dB increments

Standard dB values are 01-10, 15, 20 & 30. For all other dB values in the range of 1- 40 dB in 1 and 0.5 dB increments, please contact customer service for pricing and availability.

DC - 12.4 GHz 392 Series		
Male/Female	Female/Female	Male/Male
ATT-0392-XX-NNN-07	ATT-392F-XX-NNN-07	ATT-392M-XX-NNN-07

XX = Attenuation Value: Select 01-40 in 1 dB increments

Standard dB values are 01-10, 15, 20 & 30. For all other dB values in the range of 1- 40 dB in 1 and 0.5 dB increments, please contact customer service for pricing and availability.

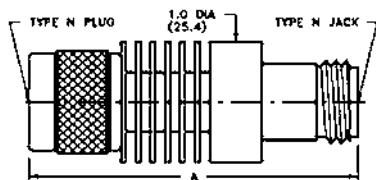

Attenuation Value	Length A
1 - 6 dB	2.38 (60.5)
7 -40 dB	2.82 (71.6)

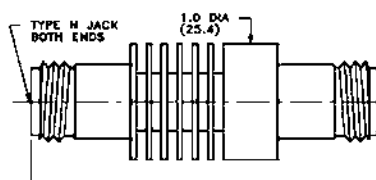

Attenuation Value	Length A
1 - 6 dB	2.32 (58.9)
7 -40 dB	2.75 (69.9)

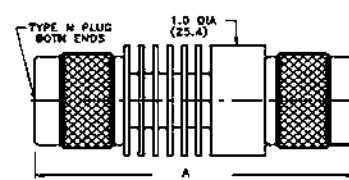

Attenuation Value	Length A
1 - 6 dB	2.48 (63.0)
7 - 40 dB	2.91 (73.9)

DC – 15.0 GHz, N Type, 20W

Specifications		
Series	ATT-0547	ATT-0528
Frequency, (GHz)	DC - 15.0	DC - 12.4
Attenuation Accuracy, (dB):	Attenuator Value	Tolerance (max)
	1-6	± 0.5
	7-10	± 0.75
	11-20	± 1.0
VSWR table, (max.):	Freq. (GHz)	VSWR
	DC - 12.4	1.35
	12.4-15.0	1.5
Average Power*, (W)	20	
Peak Power, (W):	500	
Operating Temperature, (°C)	-65 to +125	
Finish Body:	Black Anodized Aluminum	
Finish Connectors:	Passivated Stainless Steel	

* Rated @70°C, derated linearly to 5W @ 125°C



DC - 15.0 GHz 547 Series		
Male/Female	Female/Female	Male/Male
ATT-0547-XX-NNN-07	ATT-547F-XX-NNN-07	ATT-547M-XX-NNN-07

XX = Attenuation Value: Select 01-40 in 1 dB increments

Standard dB values are 01-10, 15, 20 & 30. For all other dB values in the range of 1- 40 dB in 1 and 0.5 dB increments, please contact customer service for pricing and availability.

DC - 12.4 GHz 528 Series		
Male/Female	Female/Female	Male/Male
ATT-0528-XX-NNN-07	ATT-528F-XX-NNN-07	ATT-528M-XX-NNN-07

XX = Attenuation Value: Select 01-40 in 1 dB increments

Standard dB values are 01-10, 15, 20 & 30. For all other dB values in the range of 1- 40 dB in 1 and 0.5 dB increments, please contact customer service for pricing and availability.

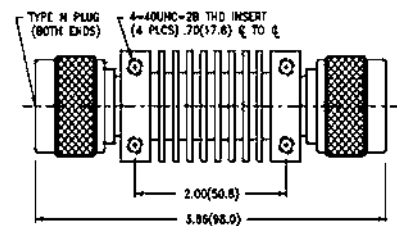
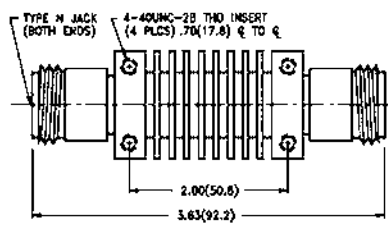
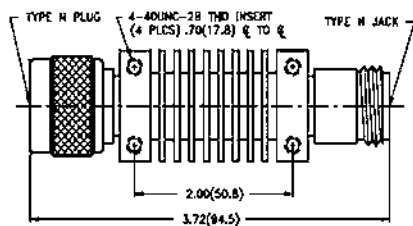

TNC Type

DC – 18.0 GHz, TNC Type

Specifications		
Series	ATT-0225	ATT-0224
Frequency, (GHz)	DC - 18.0	DC - 12.4
Attenuation Accuracy, (dB):	Attenuator Value	Tolerance (max)
	1-6	± 0.3
	7-20	± 0.5
	21-40	± 1.0
VSWR formula, (max.):	1.07 + 0.015 (f GHz)	
VSWR table, (max.):	Freq. (GHz)	VSWR
	DC - 12.4	1.25
	12.4-18.0	1.34
Average Power*, (W):	2	
Operating Temperature, (°C)	-65 to +125	
Finish Connectors:	Passivated Stainless Steel	

* Rated @25°C, derated linearly to 0.5W @ 125°C



DC - 18.0 GHz 225 Series		
Male/Female	Female/Female	Male/Male
ATT-0225-XX-TNC-02	ATT-225F-XX-TNC-02	ATT-225M-XX-TNC-02

XX = Attenuation Value: Select 01-40 in 1 dB increments
 Standard dB values are 01-10, 15, 20 & 30. For all other dB values in the range of 1- 40 dB in 1 and 0.5 dB increments, please contact customer service for pricing and availability.

DC - 12.4 GHz 224 Series		
Male/Female	Female/Female	Male/Male
ATT-0224-XX-TNC-02	ATT-224F-XX-TNC-02	ATT-224M-XX-TNC-02

XX = Attenuation Value: Select 01-40 in 1 dB increments
 Standard dB values are 01-10, 15, 20 & 30. For all other dB values in the range of 1- 40 dB in 1 and 0.5 dB increments, please contact customer service for pricing and availability.

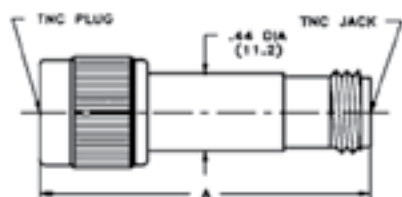

Attenuation Value	Length A
1 - 20 dB	1.57 (39.9)
21 -60 dB	1.84 (46.7)

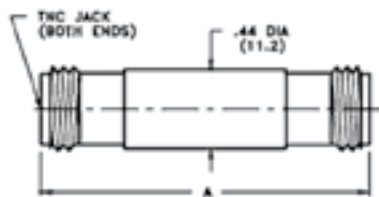

Attenuation Value	Length A
1 - 20 dB	1.66 (42.2)
21 -60 dB	1.84 (49.0)

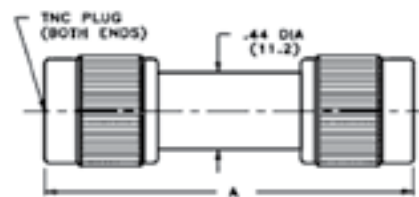

Attenuation Value	Length A
1 - 20 dB	1.71 (43.4)
21 -60 dB	1.98 (50.3)

DC – 18.0 GHz, TNC Type, 10W

Specifications		
Series	ATT-0480	ATT-0479
Frequency, (GHz)	DC - 18.0	DC - 12.4
Attenuation Accuracy, (dB):	Attenuator Value	Tolerance (max)
	1-6	± 0.5
	7-20	± 0.75
	21-40	± 1.5
VSWR table, (max.):	Freq. (GHz)	VSWR
	DC - 12.4	1.25
	12.4-18.0	1.5
Average Power*, (W)	10	
Peak Power, (W):	100	
Operating Temperature, (°C)	-65 to +125	
Finish Body:	Black Anodized Aluminum	
Finish Connectors:	Passivated Stainless Steel	



* Rated @40°C, derated linearly to 1W @ 125°C

DC - 18.0 GHz 480 Series		
Male/Female	Female/Female	Male/Male
ATT-0480-XX-TNC-07	ATT-480F-XX-TNC-07	ATT-480M-XX-TNC-07

XX = Attenuation Value: Select 01-40 in 1 dB increments

Standard dB values are 01-10, 15, 20 & 30. For all other dB values in the range of 1- 40 dB in 1 and 0.5 dB increments, please contact customer service for pricing and availability.

DC - 12.4 GHz 479 Series		
Male/Female	Female/Female	Male/Male
ATT-0479-XX-TNC-07	ATT-479F-XX-TNC-07	ATT-479M-XX-TNC-07

XX = Attenuation Value: Select 01-40 in 1 dB increments

Standard dB values are 01-10, 15, 20 & 30. For all other dB values in the range of 1- 40 dB in 1 and 0.5 dB increments, please contact customer service for pricing and availability.

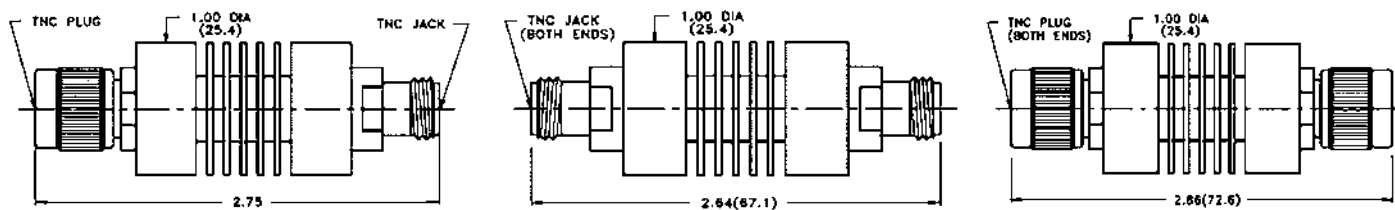

BNC Type

DC – 4.0 GHz, BNC Type, 2W and 5 W

Specifications				
Series	ATT-0581		ATT-0313	ATT-0314
Frequency, (GHz)	DC - 4.0		DC - 4.0	DC - 2.0
Attenuation Accuracy, (dB):	Attenuator Value	Tolerance (max)	Attenuator Value	Tolerance (max)
	1-6	± 0.3	1-6	± 0.3
	7-20	± 0.5	7-20	± 0.5
	11-20	± 0.75	21-40	± 0.8
	21-40	± 1.0		
VSWR table, (max.):	Freq. (GHz)	VSWR	Freq. (GHz)	VSWR
	DC - 4.0	1.25	DC-4.0	1.25
Average Power*, (W):	5		2	
Operating Temperature, (°C)	-65 to +125		-65 to +125	
Finish Body:	Black Anodized Aluminum		Nickel Plated Brass	
Finish Connectors:	Nickel Plated Brass		Nickel Plated Brass	

* Rated @25°C, derated linearly to 0.5W @ 125°C



DC - 4.0 GHz 313 Series		
Male/Female	Female/Female	Male/Male
ATT-0313-XX-BNC-10	ATT-313F-XX-BNC-10	ATT-313M-XX-BNC-10

XX = Attenuation Value: Select 01-40 in 1 dB increments
 Standard dB values are 01-10, 15, 20 & 30. For all other dB values in the range of 1- 40 dB in 1 and 0.5 dB increments, please contact customer service for pricing and availability.

DC - 2.0 GHz 314 Series		
Male/Female	Female/Female	Male/Male
ATT-0314-XX-BNC-10	ATT-314F-XX-BNC-10	ATT-314M-XX-BNC-10

XX = Attenuation Value: Select 01-40 in 1 dB increments
 Standard dB values are 01-10, 15, 20 & 30. For all other dB values in the range of 1- 40 dB in 1 and 0.5 dB increments, please contact customer service for pricing and availability.

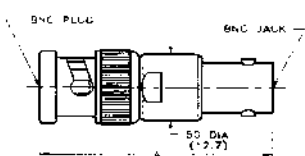

Attenuation Value	Length A
1 - 20 dB	1.36 (34.5)
21 -60 dB	1.65 (41.91)

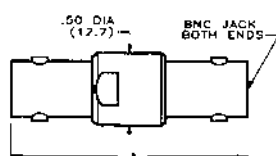

Attenuation Value	Length A
1 - 20 dB	1.43 (36.3)
21 -60 dB	1.72 (43.7)

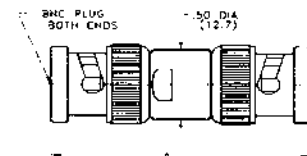

Attenuation Value	Length A
1 - 20 dB	1.55 (39.4)
21 -60 dB	1.84 (46.7)

DC - 4.0 GHz 581 Series (5 W)		
Male/Female	Female/Female	Male/Male
ATT-0581-XX-BNC-07	ATT-581F-XX-BNC-07	ATT-581M-XX-BNC-07

XX = Attenuation Value: Select 01-40 in 1 dB increments
 Standard dB values are 01-10, 15, 20 & 30. For all other dB values in the range of 1- 40 dB in 1 and 0.5 dB increments, please contact customer service for pricing and availability.

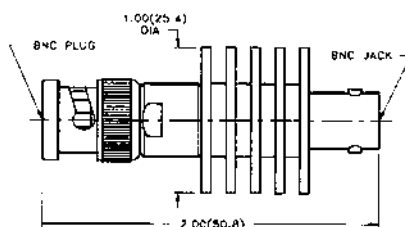

DC – 18.0 GHz, SSMA Type

Specifications		
Series	ATT-0590	
Frequency, (GHz)	DC - 18.0	
Attenuation Accuracy, (dB):	Attenuator Value	Tolerance (max)
	1-6	± 0.3
	7-10	± 0.5
VSWR table, (max.):	11-20	± 0.75
	Freq. (GHz)	VSWR
	DC - 18.0	1.25
Average Power*, (W):	2	
Operating Temperature, (°C)	-65 to +125	
Finish:	Passivated Stainless Steel	

* Rated @25°C, derated linearly to 0.5W @ 125°C



DC - 18.0 GHz 590 Series		
Male/Female	Female/Female	Male/Male
ATT-0590-XX-SSM-02	ATT-590F-XX-SSM-02	ATT-590M-XX-SSM-02

XX = Attenuation Value: Select 01-20 in 1 dB increments

Standard dB values are 01-10, 15, 20. For all other dB values in the range of 1- 20 dB in 1 and 0.5 dB increments, please contact customer service for pricing and availability.

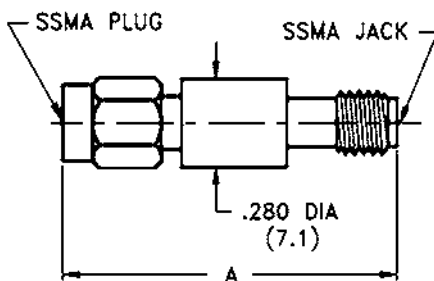

Attenuation Value	Length A
1 - 12 dB	1.10 (27.9)
13 - 20 dB	1.24 (31.5)

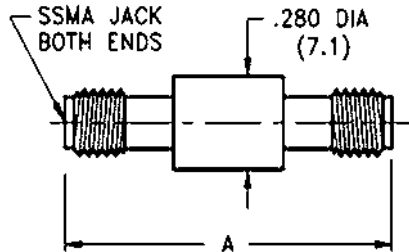

Attenuation Value	Length A
1 - 12 dB	1.11 (28.2)
13 - 20 dB	1.24 (31.5)

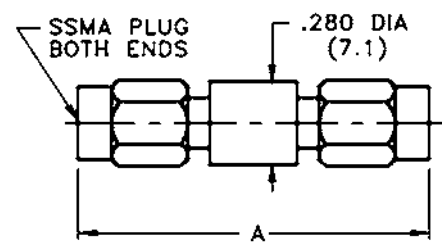

Attenuation Value	Length A
1 - 12 dB	1.04 (26.4)
13 - 20 dB	1.17 (29.7)

SMB & SMC Type

SMB and SMC

The SMB and SMC attenuators are especially suitable for use in commercial and low frequency military systems. They have been designed to withstand the same hostile environmental conditions as all of the other Midwest Microwave series of attenuators.

Specifications		
Series	ATT-0591	ATT-0592
Frequency, (GHz)	DC - 4.0	DC - 4.0
Attenuation Accuracy, (dB):	Attenuator Value	Tolerance (max)
	1-6	± 0.3
	7-10	± 0.5
	11-20	± 0.75
VSWR table, (max.):	Freq. (GHz)	VSWR
	DC - 4.0	1.25
Average Power*, (W):	2	
Peak Power, (W):	200	
Operating Temperature, (°C)	-65 to +125	
Finish:	Nickel Plated Brass	

* Rated @25°C, derated linearly to 0.5W @ 125°C

SMB Type

DC - 4.0 GHz 591 Series		
Plug/Plug	Plug/Jack	Jack/Jack
ATT-591M-XX-SMB-10	ATT-0591-XX-SMB-10	ATT-591F-XX-SMB-10

XX = Attenuation Value: Select 01-20 in 1 dB increments

Standard dB values are 01-10, 15, 20. For all other dB values in 1-20 and .5 dB increments, please contact customer service for pricing and availability.

SMC Type

DC - 4.0 GHz 592 Series		
Plug/Plug	Plug/Jack	Jack/Jack
ATT-592M-XX-SMC-10	ATT-0592-XX-SMC-10	ATT-592F-XX-SMC-10

XX = Attenuation Value: Select 01-20 in 1 dB increments

Standard dB values are 01-10, 15, 20. For all other dB values in 1-20 and .5 dB increments, please contact customer service for pricing and availability.

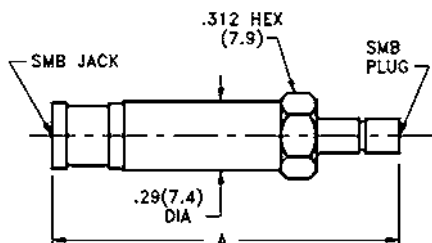

Attenuation Value	Length A
1 - 12 dB	1.42 (36.0)
13 - 20 dB	1.54 (39.1)

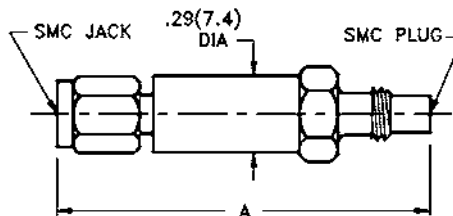

Attenuation Value	Length A
1 - 12 dB	1.42 (36.0)
13 - 20 dB	1.54 (39.1)

DC – 18.0 GHz, Calibration Sets, SMA, 7mm, N

Specifications			
Series	ATS-3554	ATS-3552	ATS-3551
Interface	SMA	7mm	N
Frequency, (GHz)	DC - 18.0	DC - 18.0	DC - 18.0
Attenuation Accuracy, (dB):	Attenuator Value	Tolerance (max)	
	3 & 6	± 0.3	
	10 & 20	± 0.5	
VSWR formula, (max.):	1.07 + 0.015(f GHz)		
VSWR table, (max.):	Freq. (GHz)	VSWR	
	DC - 12.4	1.25	
	12.4-18.0	1.34	
Average Power*, (W):	2		
Calibration supplied at, GHz	4.0, 8.0, 12.4, 18.0		
Operating Temperature, (°C)	-65 to +125		
Finish:	Passivated Stainless Steel		

* Rated @25°C, derated linearly to 0.5W @ 125°C

Midwest Microwave’s Calibrated Attenuator Sets consist of a set of four precision, broadband, fixed attenuators with values of 3, 6, 10, and 20 dB. These sets are available with a choice of SMA, N, or 7mm passivated stainless steel precision connectors.

Calibrated Attenuator Sets are intended for laboratory or field use. The precision, broadband, fixed attenuators are supplied in a shock resistant storage case. The inside cover of the storage case holds the calibration data.

The calibration data includes test results at DC, 4.0, 8.0, 12.4, and 18.0 GHz. All measurement standards used have calibration traceability to the National Bureau of Standards.



SMA

DC - 18.0 GHz
Male/Female
ATS-3554-18-SMA-02



7mm

DC - 18.0 GHz
7mm
ATS-3552-18-7MM-02



Type N

DC - 18.0 GHz
Male/Female
ATS-3551-18-NNN-02

Adapter Pads

DC – 18.0 GHz, Adapter Pads, N to SMA

Specifications				
Series	ADP-0101	ADP-0102	ADP-0103	ADP-0104
Interface	N(m)-SMA(m)	N(m)-SMA(f)	N(f)-SMA(m)	N(f)-SMA(f)
Frequency, (GHz)	DC - 18.0	DC - 18.0	DC - 18.0	DC - 18.0
Attenuation Accuracy, (dB):	Attenuator Value		Tolerance (max)	
	1-6		± 0.3	
	7-20		± 0.5	
VSWR table, (max.):	21-30		± 1.0	
	Freq. (GHz)		VSWR	
	DC - 4.0		1.1	
	4.0-10.0		1.2	
	10.0-18.0		1.3	
Average Power*, (W):	2			
Calibration supplied at, GHz	4.0, 8.0, 12.4, 18.0			
Operating Temperature, (°C)	-65 to +125			
Finish:	Passivated Stainless Steel			

* Rated @25°C, derated linearly to 0.5W @ 125°C



Type N Male to SMA

DC - 18.0 GHz	
Type N Male / SMA Male	Type N Male / SMA Female
ADP-0101-XX-000-02	ADP-0102-XX-000-02

XX = Attenuation Value
Standard dB values are 01-10, 15, 20, 30.

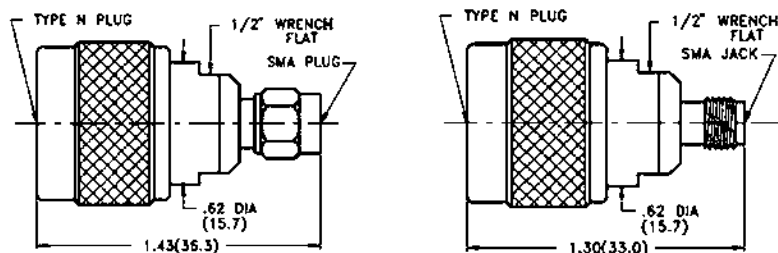

Type N Female to SMA

DC - 18.0 GHz	
Type N Female / SMA Male	Type N Female / SMA Female
ADP-0103-XX-000-02	ADP-0104-XX-000-02

XX = Attenuation Value
Standard dB values are 01-10, 15, 20, 30.

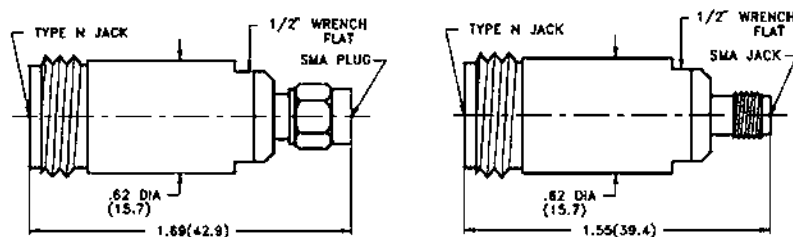

Terminations

General Information	32
SMA Miniature Male Plug	33
SMA Miniature Female Jack	34
SMA Miniature Male Plug	35
SMA Miniature Female Jack	36
SMA Miniature Male Plug	37
SMA Miniature Female Jack	38
3.5mm 26.5 GHz Type.....	39
SMA Medium Power Types	40
SSMA – SMMA.....	43
BMA Blind Mates Types	44
SMB – SMC Types	45
7mm Type	46
Type N.....	47
Type N Economical Types	48
Type N – Medium Power Types.....	49
TNC Type.....	50
TNC Medium Power Types.....	51
BNC Type	52
SC Type	53
HN Type	54
Mismatches.....	55
Short and Open Circuits	56
Feed Thru Type.....	57

3	Attenuators
----------	--------------------

31	Terminations
-----------	---------------------

58	DC Blocks
-----------	------------------

61	Couplers
-----------	-----------------

73	Power Dividers
-----------	-----------------------

81	Equalizers
-----------	-------------------

85	Phase Shifters
-----------	-----------------------

87	Between Series Adapters
-----------	--------------------------------

116	In-Series Adapters
------------	---------------------------

127	Connectors
------------	-------------------

177	QPL Approved Products & Tools for Assembly
------------	---

200	Appendix
------------	-----------------

209	Index
------------	--------------

While every precaution has been taken to ensure accuracy and completeness herein, Emerson Network Power Connectivity Solutions assumes no responsibility, and disclaims all liability for damages resulting from use of this information or for any errors or omissions. Specifications subject to change without notice.

General Information

- MIL-DTL-39030 Qualified (QPL)
- DC - 40.0 GHz Performance
- Small Size, Light Weight, Rugged Construction
- Average Power up to 20 Watts
- SMA, BMA, N, TNC, BNC, SC, 3.5mm, and 7mm Connector Configurations

Midwest Microwave Coaxial Terminations are designed to meet the extreme demands of today's microwave test or operating system applications. Standard catalog units are available off the shelf for immediate delivery, or special units can be custom designed by Midwest's engineering staff to accommodate unique system needs. All Midwest Terminations are completely manufactured in-house and are 100% tested to insure only the highest quality performance whether for military or space use or for commercial cellular or personal communication applications.

They are available in a complete assortment of connector interfaces and are small in size and light in weight. Feed thru terminations and precision shorts and opens are also available. All Midwest Microwave Terminations are ruggedly constructed of stainless steel and are 100% swept frequency tested to assure that the highest quality performance possible is attained. They possess 50 Ohm impedance and will operate successfully over the temperature range of -55°C to +125°C and will exhibit low VSWR over the entire frequency range. Midwest Microwave offers this complete product line of Coaxial Terminations, ruggedly designed for system or laboratory and that meet the toughest environmental requirements. Average power levels of up to 20 Watts are available providing broadband performance and low frequency sensitivity with good temperature stability. Other standard Terminations such as precision mismatches, short and open circuit units are also available.



Typical Coaxial Termination Performance

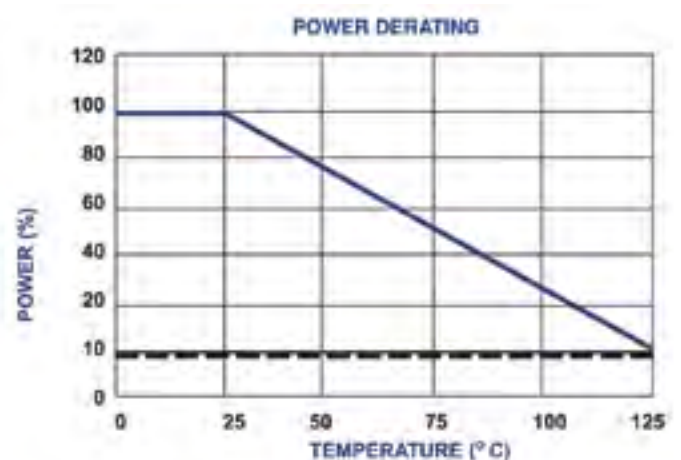
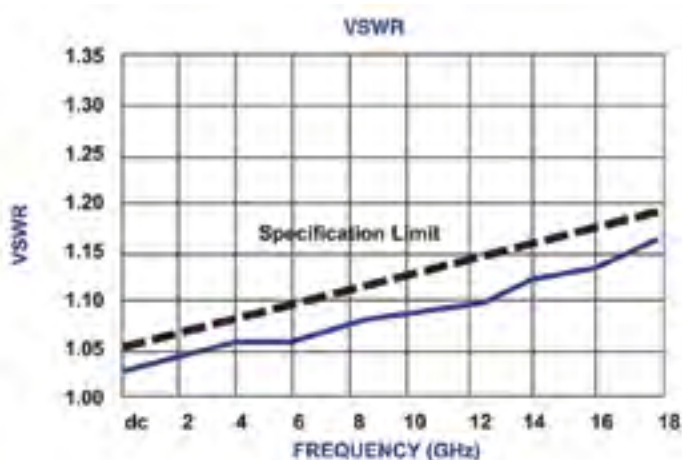

Ultra Short – 0.5 Watt High Performance

- DC - 8.0, DC - 18.0, and DC - 26.5 GHz Units
- Low VSWR
- Rugged Stainless Steel Construction
- Small Size, Light Weight
- Bead Chain Available on all Models

Midwest Microwave’s SMA miniature series of high performance coaxial terminations provide temperature stable, ruggedly built, low VSWR precision performance in a compact light weight package size. Bead Chains are available with any of the units described.



Specifications			
Series	TRM-2443	TRM-2444	TRM-2446
Frequency, (GHz)	DC - 26.5	DC - 18.0	DC - 8.0
VSWR formula, (max.):	1.05 + 0.008(f GHz) for DC-18 GHz only		
VSWR table, (max.):	Freq. (GHz)		VSWR
	DC - 8.0		1.11
	8.0-18.0		1.19
	18.0-26.5		1.3
Nominal Impedance, (Ω)	50		
Average Power*, (W):	0.5		
Operating Temperature, (°C)	-55 to +125		
Finish:	Passivated Stainless Steel		

* Rated @25°C, derated linearly to 0W @ 125°C

DC - 26.5 GHz 2443 Series	
Male Plug	Male Plug with Chain
TRM-2443-MO-SMA-02	TRM-2443-MC-SMA-02

DC - 18.0 GHz 2444 Series	
Male Plug	Male Plug with Chain
TRM-2444-MO-SMA-02	TRM-2444-MC-SMA-02

DC - 8.0 GHz 2446 Series	
Male Plug	Male Plug with Chain
TRM-2446-MO-SMA-02	TRM-2446-MC-SMA-02

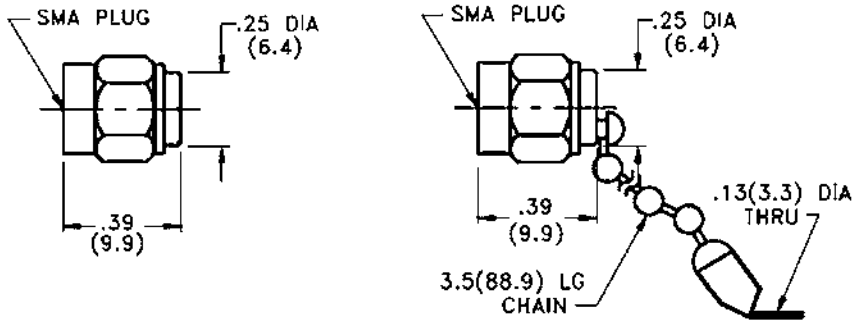

SMA Miniature Female Jack

Ultra Short – 0.5 Watt High Performance

- DC - 8.0, DC - 18.0, and DC - 26.5 GHz Units
- Low VSWR
- Rugged Stainless Steel Construction
- Small Size, Light Weight
- Bead Chain Available on all Models

Midwest Microwave's SMA miniature series of high performance coaxial terminations provide temperature stable, ruggedly built, low VSWR precision performance in a compact light weight package size. Bead Chains are available with any of the units described.



Specifications			
Series	TRM-2443	TRM-2444	TRM-2446
Frequency, (GHz)	DC - 26.5	DC - 18.0	DC - 8.0
VSWR formula, (max.):	1.05 + 0.008(f GHz) for DC-18 GHz only		
VSWR table, (max.):	Freq. (GHz)	VSWR	
	DC - 8.0	1.11	
	8.0-18.0	1.19	
	18.0-26.5	1.3	
Nominal Impedance, (Ω)	50		
Average Power*, (W):	0.5		
Operating Temperature, ($^{\circ}$ C)	-55 to +125		
Finish:	Passivated Stainless Steel		

* Rated @25 $^{\circ}$ C, derated linearly to 0W @ 125 $^{\circ}$ C

DC - 26.5 GHz 2443 Series	
Female Jack	Female Jack with Chain
TRM-2443-FO-SMA-02	TRM-2443-FC-SMA-02

DC - 18.0 GHz 2444 Series	
Female Jack	Female Jack with Chain
TRM-2444-FO-SMA-02	TRM-2444-FC-SMA-02

DC - 8.0 GHz 2446 Series	
Female Jack	Female Jack with Chain
TRM-2446-FO-SMA-02	TRM-2446-FC-SMA-02

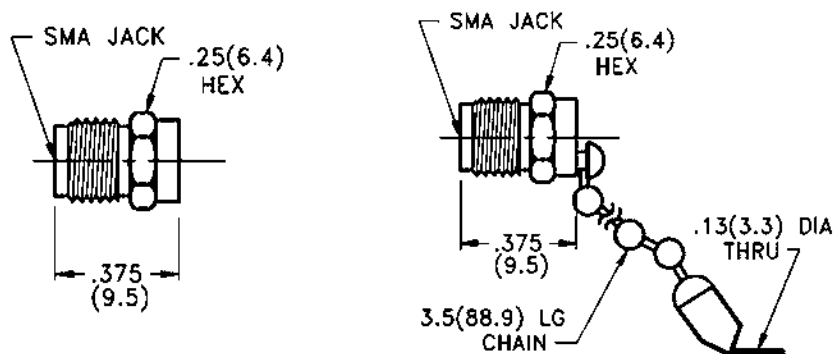

2 Watt High Performance

- DC - 8.0, DC - 18.0, and DC - 26.5 GHz Units
- Low VSWR
- Rugged Stainless Steel Construction
- Small Size, Light Weight
- Bead Chain Available on all Models

Midwest Microwave's SMA miniature series of high performance coaxial terminations provide temperature stable, ruggedly built, low VSWR precision performance in a compact light weight package size. Bead Chains are available with any of the units described.



Specifications			
Series	TRM-2054	TRM-2055	TRM-2058
Frequency, (GHz)	DC - 26.5	DC - 18.0	DC - 8.0
VSWR formula, (max.):	1.05 + 0.008(f GHz) for DC-18 GHz only		
VSWR table, (max.):	Freq. (GHz)		VSWR
	DC - 8.0		1.11
	8.0-18.0		1.19
	18.0-26.5		1.3
Nominal Impedance, (Ω)	50		
Average Power*, (W):	2		
Operating Temperature, (°C)	-65 to +125		
Finish:	Passivated Stainless Steel		

* Rated @25°C, derated linearly to 1W @ 125°C

DC - 26.5 GHz 2054 Series	
Male Plug	Male Plug with Chain
TRM-2054-MO-SMA-02	TRM-2054-MC-SMA-02

DC - 18.0 GHz 2055 Series	
Male Plug	Male Plug with Chain
TRM-2055-MO-SMA-02	TRM-2055-MC-SMA-02

DC - 8.0 GHz 2058 Series	
Male Plug	Male Plug with Chain
TRM-2058-MO-SMA-02	TRM-2058-MC-SMA-02

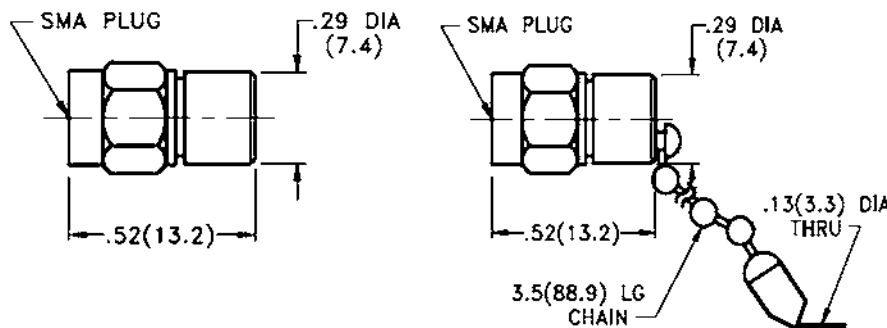

SMA Miniature Female Jack

Low VSWR – 2 Watt High Performance

- DC - 8.0, DC - 18.0, and DC - 26.5 GHz Units
- Low VSWR
- Rugged Stainless Steel Construction
- Small Size, Light Weight
- Bead Chain Available on all Models

Midwest Microwave's SMA miniature series of high performance coaxial terminations provide temperature stable, ruggedly built, low VSWR precision performance in a compact light weight package size. Bead Chains are available with any of the units described.



Specifications			
Series	TRM-2054	TRM-2055	TRM-2058
Frequency, (GHz)	DC - 26.5	DC - 18.0	DC - 8.0
VSWR formula, (max.):	1.05 + 0.008(f GHz) for DC-18 GHz only		
VSWR table, (max.):	Freq. (GHz)	VSWR	
	DC - 8.0	1.11	
	8.0-18.0	1.19	
	18.0-26.5	1.3	
Nominal Impedance, (Ω)	50		
Average Power*, (W):	2		
Operating Temperature, ($^{\circ}$ C)	-65 to +125		
Finish:	Passivated Stainless Steel		

* Rated @25 $^{\circ}$ C, derated linearly to 1W @ 125 $^{\circ}$ C

DC - 26.5 GHz 2054 Series

Female Jack	Female Jack with Chain
TRM-2054-FO-SMA-02	TRM-2443-FC-SMA-02

DC - 18.0 GHz 2055 Series

Female Jack	Female Jack with Chain
TRM-2055-FO-SMA-02	TRM-2055-FC-SMA-02

DC - 8.0 GHz 2058 Series

Female Jack	Female Jack with Chain
TRM-2058-FO-SMA-02	TRM-2058-FC-SMA-02

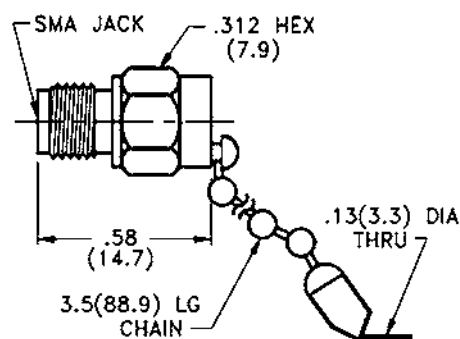
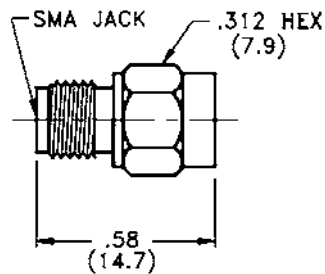

Low VSWR 2 Watt High Performance

- DC - 8.0, DC - 18.0, and DC - 26.5 GHz Units
- Low VSWR
- Rugged Stainless Steel Construction
- Small Size, Light Weight
- Bead Chain Available on all Models



Midwest Microwave's SMA miniature series of high performance coaxial terminations provide temperature stable, ruggedly built, low VSWR precision performance in a compact light weight package size. These models offer improved, lower VSWR performance over other units described on the previous page. Bead Chains are available with any of the units described.

Specifications			
Series	TRM-2089	TRM-2090	TRM-2092
Frequency, (GHz)	DC - 26.5	DC - 18.0	DC - 8.0
VSWR table, (max.):	Freq. (GHz)		VSWR
	DC - 4.0		1.05
	4.0-12.0		1.1
	12.0-18.0		1.14
	18.0-26.5		1.3
Nominal Impedance, (Ω)	50		
Average Power*, (W):	2		
Operating Temperature, (°C)	-65 to +125		
Finish:	Passivated Stainless Steel		

* Rated @25°C, derated linearly to 1W @ 125°C

DC - 26.5 GHz 2089 Series	
Male Plug	Male Plug with Chain
TRM-2089-MO-SMA-02	TRM-2089-MC-SMA-02

DC - 18.0 GHz 2090 Series	
Male Plug	Male Plug with Chain
TRM-2090-MO-SMA-02	TRM-2090-MC-SMA-02

DC - 8.0 GHz 2092 Series	
Male Plug	Male Plug with Chain
TRM-2092-MO-SMA-02	TRM-2092-MC-SMA-02

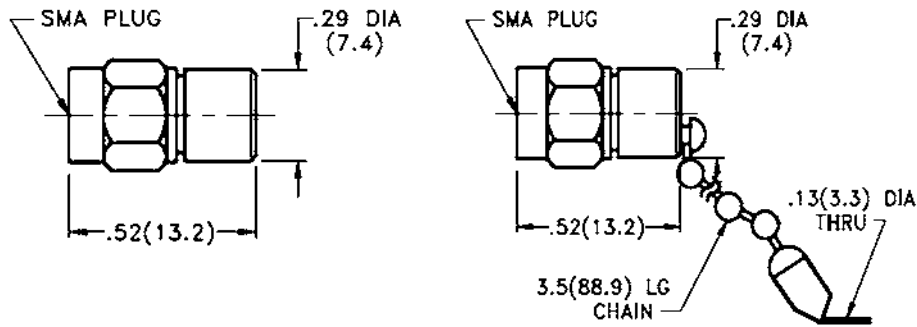

SMA Miniature Female Jack

Low VSWR – 2 Watt High Performance

- DC - 8.0, DC - 18.0, and DC - 26.5 GHz Units
- Low VSWR
- Rugged Stainless Steel Construction
- Small Size, Light Weight
- Bead Chain Available on all Models

Midwest Microwave's SMA miniature series of high performance coaxial terminations provide temperature stable, ruggedly built, low VSWR precision performance in a compact light weight package size. These models offer improved, lower VSWR performance over other units described on the previous page. Bead Chains are available with any of the units described.



Specifications			
Series	TRM-2089	TRM-2090	TRM-2092
Frequency, (GHz)	DC - 26.5	DC - 18.0	DC - 8.0
VSWR table, (max.):	Freq. (GHz)		VSWR
	DC - 4.0		1.05
	4.0-12.0		1.1
	12.0-18.0		1.14
	18.0-26.5		1.3
Nominal Impedance, (Ω)	50		
Average Power*, (W):	2		
Operating Temperature, ($^{\circ}$ C)	-65 to +125		
Finish:	Passivated Stainless Steel		

* Rated @25 $^{\circ}$ C, derated linearly to 1W @ 125 $^{\circ}$ C

DC - 26.5 GHz 2089 Series

Female Jack	Female Jack with Chain
TRM-2089-FO-SMA-02	TRM-2089-FC-SMA-02

DC - 18.0 GHz 2090 Series

Female Jack	Female Jack with Chain
TRM-2090-FO-SMA-02	TRM-2090-FC-SMA-02

DC - 8.0 GHz 2092 Series

Female Jack	Female Jack with Chain
TRM-2092-FO-SMA-02	TRM-2092-FC-SMA-02

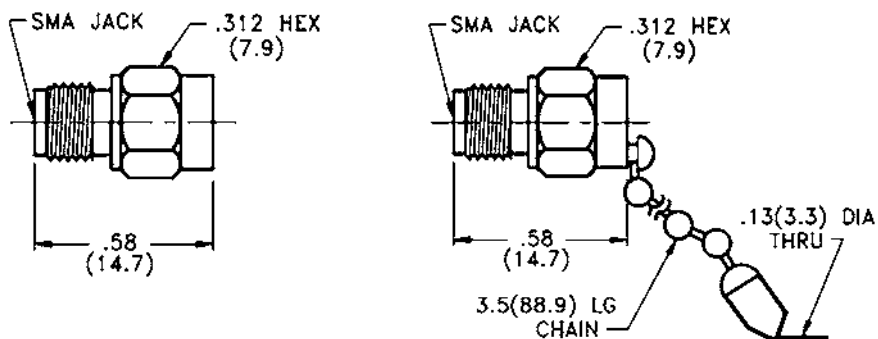

DC – 26.5 GHz – 2 Watts High Performance

- Low VSWR
- Rugged Stainless Steel Construction
- Small Size, Light Weight
- Bead Chain Available on all Models
- Mates with Standard SMA Interface



Midwest Microwave's 3.5mm series of high performance coaxial Terminations provide temperature stable, ruggedly built, low VSWR precision performance in a compact light weight package size. All Models mate non-destructively with standard SMA connector interfaces. Bead Chains are available with any of the units described.

Specifications		
Series	TRM-2160	TRM-2161
Frequency, (GHz)	DC - 26.5	DC - 18.0
VSWR table, (max.):	Freq. (GHz)	VSWR
	DC - 18.0	1.12
	18.0-26.5	1.18
Nominal Impedance, (Ω)	50	
Average Power*, (W):	2	
Operating Temperature, (°C)	-65 to +125	
Finish:	Passivated Stainless Steel	

* Rated @25°C, derated linearly to 1W @ 125°C

DC - 26.5 GHz 2160 Series			
Male Plug	Male Plug with Chain	Female Jack	Female Jack with Chain
TRM-2160-M0-35M-02	TRM-2160-MC-35M-02	TRM-2160-F0-35M-02	TRM-2160-FC-35M-02

DC - 18.0 GHz 2161 Series			
Male Plug	Male Plug with Chain	Female Jack	Female Jack with Chain
TRM-2161-M0-35M-02	TRM-2161-MC-35M-02	TRM-2161-F0-35M-02	TRM-2161-FC-35M-02

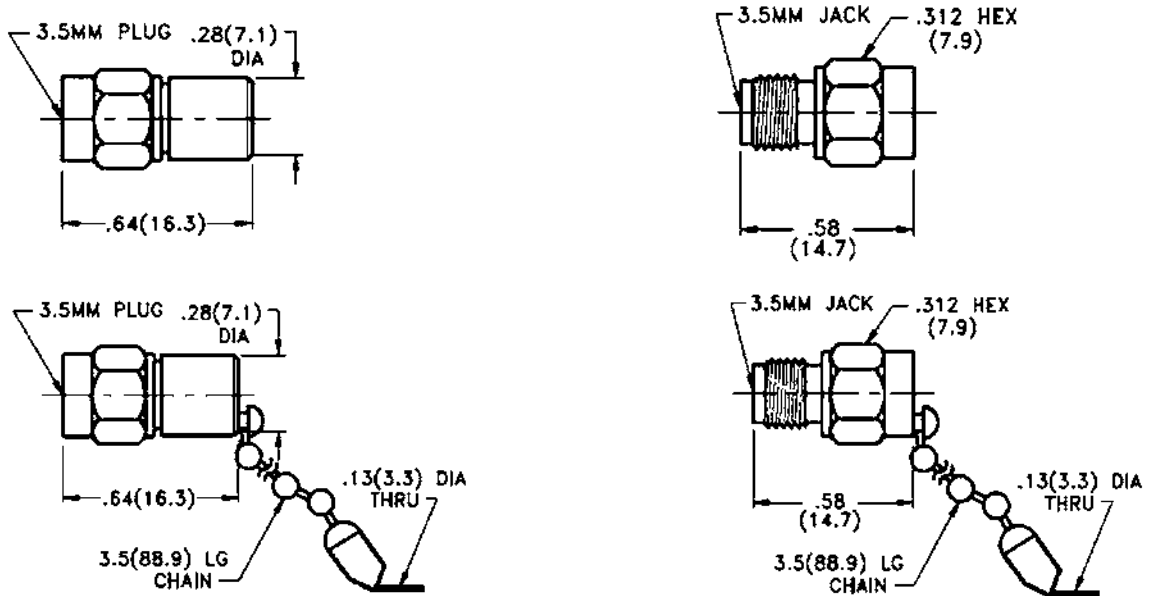

SMA Medium Power Types

DC – 18.0 GHz High Performance

- 3, 5, and 10 Watt Model Selection
- Broad Frequency Band Coverage
- Low VSWR – 50 Ohm – High Performance.
- Rugged Stainless Steel Interface Construction



Specifications			
Series	TRM-2057	TRM-2010	TRM-2013
Average Power, (W)	3*	5**	10*
Frequency, (GHz)	DC - 18.0	DC - 18.0	DC - 18.0
VSWR formula, (max.):	1.05 + 0.01 (f GHz)		
VSWR table, (max.):	Freq. (GHz)		VSWR
	DC - 8.0		1.13
	8.0-18.0		1.23
Nominal Impedance, (Ω)	50		
Operating Temperature, (°C)	-65 to +125		
Finish, Body:	Black Anodized Aluminum		
Finish, Connectors:	Passivated Stainless Steel		

* Rated @25°C, derated linearly to 1W* or 0.5W** @ 125°C

Midwest Microwave's SMA series of medium power coaxial Terminations provide temperature stable, ruggedly built, precision performance in light weight reasonably sized packages using stainless steel connectors and black anodized finned aluminum housings. Input Power levels of 3, 5, and 10 Watts are offered with low VSWR performance.

3 Watts - DC - 18.0 GHz

DC - 18.0 GHz 2057 Series			
Male Plug	Male Plug with Chain	Female Jack	Female Jack with Chain
TRM-2057-M0-SMA-07	TRM-2057-MC-SMA-07	TRM-2057-F0-SMA-07	TRM-2057-FC-SMA-07

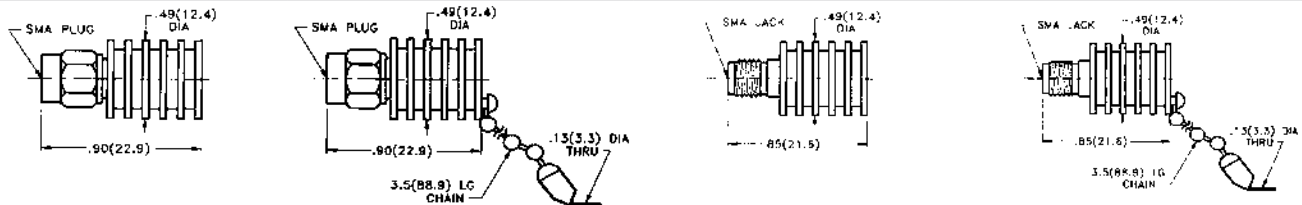

5 Watts - DC - 18.0 GHz

DC - 18.0 GHz 2010 Series			
Male Plug	Male Plug with Chain	Female Jack	Female Jack with Chain
TRM-2010-M0-SMA-07	TRM-2010-MC-SMA-02	TRM-2010-F0-SMA-07	TRM-2010-FC-SMA-02

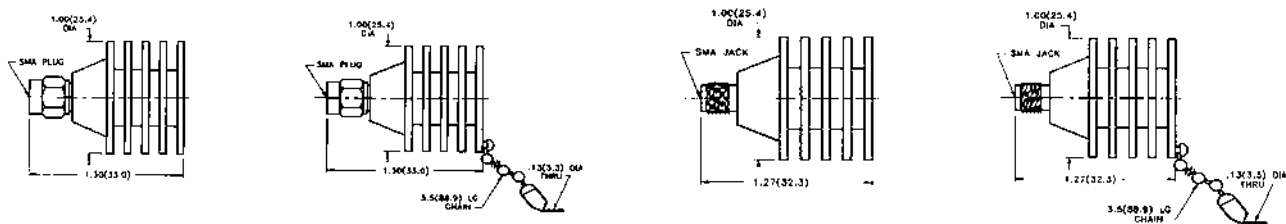

10 Watts - DC - 18.0 GHz

DC - 18.0 GHz 2013 Series			
Male Plug	Male Plug with Chain	Female Jack	Female Jack with Chain
TRM-2013-M0-SMA-07	TRM-2013-MC-SMA-072	TRM-2013-F0-SMA-07	TRM-2013-FC-SMA-072

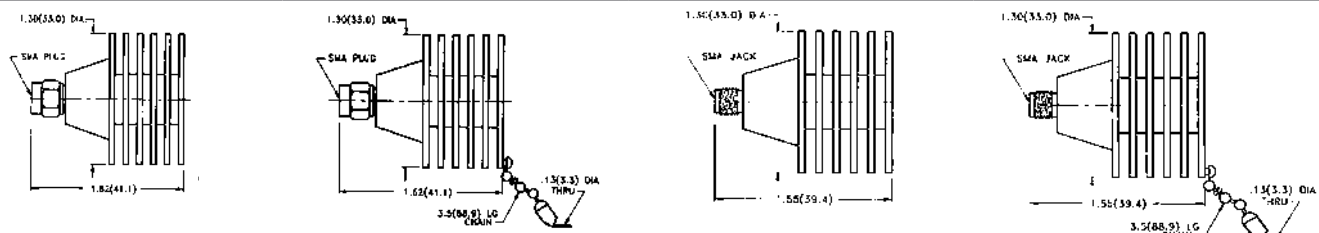



10 and 20 Watt – DC – 18.0 GHz

- 10 and 20 Watt Model Selection
- Broad Frequency Band Coverage
- Low VSWR
- Rugged Stainless Steel Interface Construction

Midwest Microwave’s SMA series of medium power coaxial Terminations provide temperature stable, ruggedly built, precision performance in light weight reasonably sized packages using stainless steel connectors and black anodized finned aluminum housings. Input Power levels of 10 and 20 Watts are offered with low VSWR performance.

Specifications		
Series	TRM-2138	TRM-2129
Average Power, (W)	10*	20**
Peak Power, (kW):	1	6
Frequency, (GHz)	DC - 18.0	DC - 18.0
VSWR table, (max.):	Freq. (GHz)	VSWR
	DC - 12.4	1.25
	12.4-18.0	1.35
Nominal Impedance, (Ω)	50	
Operating Temperature, ($^{\circ}\text{C}$)	-55 to +125	
Finish, Body:	Black Anodized Aluminum	
Finish, Connectors:	Passivated Stainless Steel	

* Rated @25°C, derated linearly to 0W @ 125°C
 ** Rated @40°C, derated linearly to 5W @ 125°C

10 Watts - DC - 18.0 GHz

DC - 18.0 GHz 2138 Series	
Male Plug	Male Plug with Chain
TRM-2138-M0-SMA-07	TRM-2138-MC-SMA-07

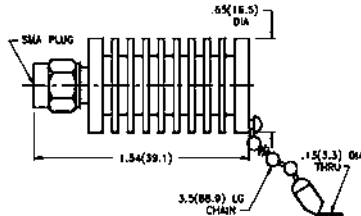
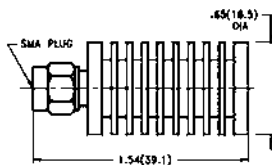

20 Watts - DC - 18.0 GHz

DC - 18.0 GHz 2129 Series	
Male Plug	Male Plug with Chain
TRM-2129-M0-SMA-07	TRM-2129-MC-SMA-07

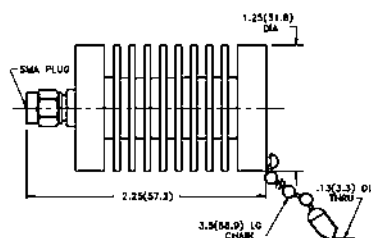
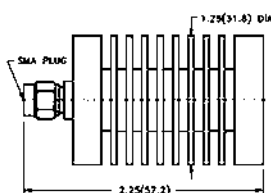

SMA Medium Power Types

10 and 20 Watt – DC – 18.0 GHz

- 10 and 20 Watt Model Selection
- Broad Frequency Band Coverage
- Low VSWR
- Rugged Stainless Steel Interface Construction

Midwest Microwave's SMA series of medium power coaxial Terminations provide temperature stable, ruggedly built, precision performance in light weight reasonably sized packages using stainless steel connectors and black anodized finned aluminum housings. Input Power levels of 10 and 20 Watts are offered with low VSWR performance.



Specifications		
Series	TRM-2138	TRM-2129
Average Power, (W)	10*	20**
Peak Power, (kW):	1	6
Frequency, (GHz)	DC - 18.0	DC - 18.0
VSWR table, (max.):	Freq. (GHz)	VSWR
	DC - 12.4	1.25
	12.4-18.0	1.35
Nominal Impedance, (Ω)	50	
Operating Temperature, ($^{\circ}\text{C}$)	-55 to +125	
Finish, Body:	Black Anodized Aluminum	
Finish, Connectors:	Passivated Stainless Steel	

* Rated @25 $^{\circ}\text{C}$, derated linearly to 0W @ 125 $^{\circ}\text{C}$

** Rated @40 $^{\circ}\text{C}$, derated linearly to 5W @ 125 $^{\circ}\text{C}$

10 Watts - DC - 18.0 GHz

DC - 18.0 GHz 2138 Series	
Female Jack	Female Jack with Chain
TRM-2138-F0-SMA-07	TRM-2138-FC-SMA-07

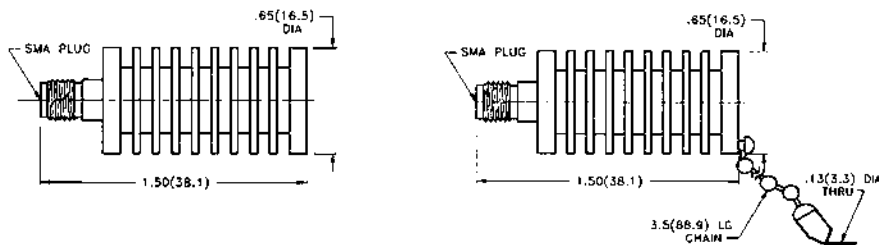

20 Watts - DC - 18.0 GHz

DC - 18.0 GHz 2129 Series	
Female Jack	Female Jack with Chain
TRM-2129-F0-SMA-07	TRM-2129-FC-SMA-07

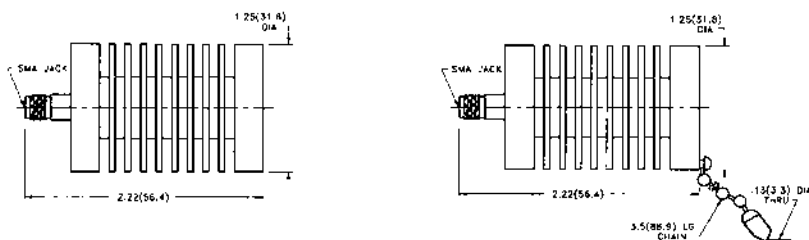

DC – 18.0 GHz – 0.5 Watts High Performance

- Low VSWR
- Rugged Stainless Steel Construction
- Small Size, Light Weight
- Bead Chain on Subminiature Models

Midwest Microwave's SSMA Subminiature and SMMA Ultraminiature series of high performance coaxial Terminations provide temperature stable, ruggedly built, low VSWR precision performance in a compact light weight package size. Bead Chains are available with the Subminiature units, but are not available with the Ultraminiature units.



Specifications		
Series	TRM-2180	TRM-2181
Interface	SSMA	SMMA
Frequency, (GHz)	DC - 18.0	DC - 18.0
VSWR formula, (max.):	1.1 + 0.01 (f GHz)	
VSWR table, (max.):	Freq. (GHz)	VSWR
	DC - 12.4	1.22
	12.4-18.0	1.28
Nominal Impedance, (Ω)	50	
Average Power*, (W):	0.5	
Operating Temperature, (°C)	-55 to +125	
Finish:	Passivated Stainless Steel	

* Rated @25°C, derated linearly to 0W @ 125°C

Subminiature

DC - 18.0 GHz 2180 Series			
Male Plug	Male Plug with Chain	Female Jack	Female Jack with Chain
TRM-2180-M0-SSM-02	TRM-2180-MC-SSM-02	TRM-2180-F0-SSM-02	TRM-2180-FC-SSM-02

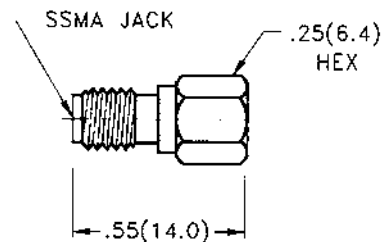
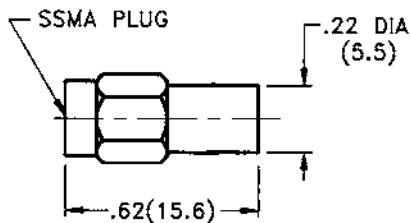

Ultraminiature

DC - 18.0 GHz 2181 Series	
Male Plug	Female Jack
TRM-2181-M0-SMM-02	TRM-2181-F0-SMM-02

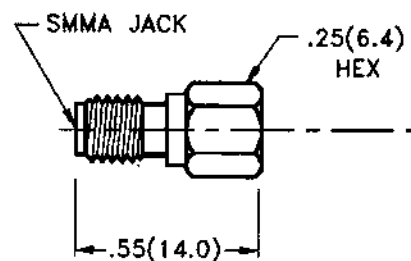
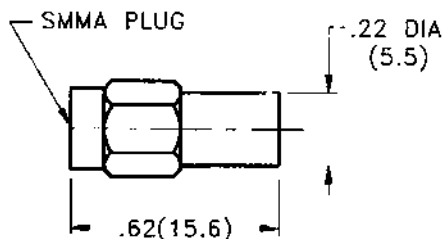

BMA Blind Mate Types

DC – 18.0 GHz – 0.5 Watt High Performance

- Low VSWR
- Rugged Stainless Steel Construction
- Small Size, Light Weight
- Bead Chain Available on all Models

Midwest Microwave's BMA Miniature series of high performance coaxial Terminations provide temperature stable, ruggedly built, low VSWR precision performance in a compact light weight package size. Bead Chains are available with all of the types described.



Specifications		
Series	TRM-2191	TRM-2193
Frequency, (GHz)	DC - 18.0	DC - 18.0
VSWR formula, (max.):	1.1 + 0.01 (f GHz)	
VSWR table, (max.):	Freq. (GHz)	VSWR
	DC - 12.4	1.22
	12.4-18.0	1.28
Nominal Impedance, (Ω)	50	
Average Power*, (W):	0.5	
Operating Temperature, ($^{\circ}$ C)	-65 to +125	
Finish:	Passivated Stainless Steel	

* Rated @25 $^{\circ}$ C, derated linearly to 0W @ 125 $^{\circ}$ C

DC - 18.0 GHz 2191 Series

Male Plug	Male Plug with Chain	Female Jack	Female Jack with Chain
TRM-2191-M0-BMA-02	TRM-2191-MC-BMA-02	TRM-2191-F0-BMA-02	TRM-2191-FC-BMA-02

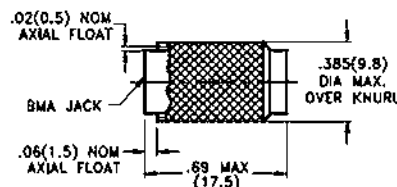
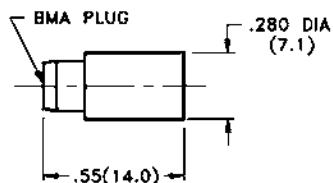

DC - 18.0 GHz 2193 Series

Female Jack

TRM-2193-F0-BMA-02

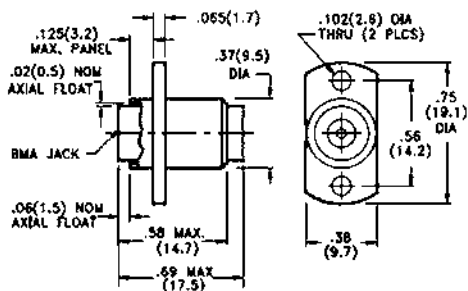

DC – 4.0 GHz – 0.5 Watt Performance

- Low VSWR
- Rugged Stainless Steel Construction
- Small Size, Light Weight
- Bead Chain Available on all Models

Midwest Microwave's SMB and SMC Subminiature series of high performance low frequency coaxial Terminations provide temperature stable, ruggedly built, low VSWR performance in a compact lightweight package size. They are useful in commercial low frequency communication systems as well as military applications. Bead Chains are available with the all of the types described.



Specifications		
Series	TRM-2198	TRM-2199
Interface	SMA	SMC
Frequency, (GHz)	DC - 4.0	DC - 4.0
VSWR table, (max.):	Freq. (GHz)	VSWR
	DC - 2.0	1.15
	2.0-4.0	1.25
Nominal Impedance, (Ω)	50	
Average Power*, (W):	0.5	
Operating Temperature, ($^{\circ}$ C)	-65 to +125	
Finish:	Passivated Stainless Steel	

* Rated @25°C, derated linearly to 0W @ 125°C

SMB Subminiature

DC - 4.0 GHz 2198 Series			
Jack	Jack with Chain	Plug	Plug with Chain
TRM-2198-F0-SMB-02	TRM-2198-FC-SMB-02	TRM-2198-M0-SMB-02	TRM-2198-MC-SMB-02

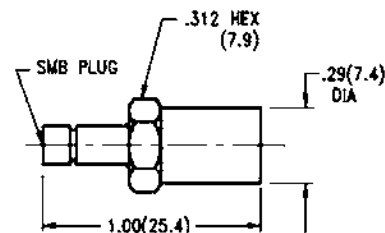
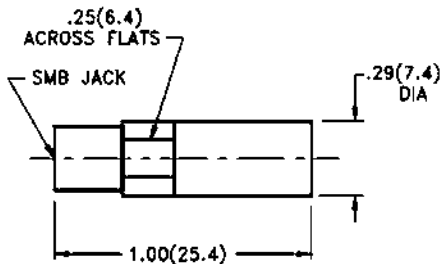

SMC Subminiature

DC - 4.0 GHz 2199 Series			
Jack	Jack with Chain	Plug	Plug with Chain
TRM-2199-F0-SMC-02	TRM-2199-FC-SMC-022	TRM-2199-M0-SMC-02	TRM-2199-MC-SMC-02

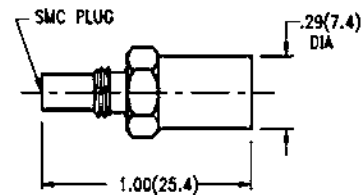
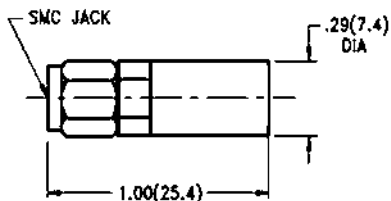

7mm Type

DC – 18.0 GHz Precision Performance

- 7mm Precision Performance
- Broad Frequency Band Coverage
- Low VSWR – 50 Ohm – High Performance
- Rugged Stainless Steel Interface Constructions

Midwest Microwave's 7mm series of coaxial Terminations provide temperature stable, ruggedly built, precision performance in light weight reasonably sized packages using stainless steel connectors. Low VSWR performance is exhibited and units are suitable for laboratory test systems as well as operating systems.



Specifications			
Series		TRM-2002	TRM-2052
Frequency, (GHz)		DC - 18.0	DC - 18.0
VSWR formula, (max.):		1.025+.002 (f GHz)	N/A
VSWR table, (max.):	Freq. (GHz)	VSWR	VSWR
	DC - 4.0	1.03	1.05
	4.0-12.0	1.05	1.1
	12.0-18.0	1.06	1.15
Nominal Impedance, (Ω)	50		
Operating Temperature, ($^{\circ}\text{C}$)	-65 to +125		
Average Power, (W)*	2		
Finish:	Passivated Stainless Steel		

* Rated @25°C, derated linearly to 0.5W @ 125°C

7mm Precision DC – 18.0 GHz

DC - 18.0 GHz 2002 Series

7mm	7mm with Chain
TRM-2002-00-7MM-02	TRM-2002-0C-7MM-02

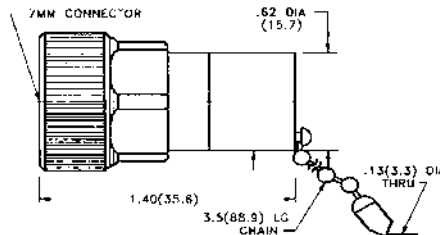
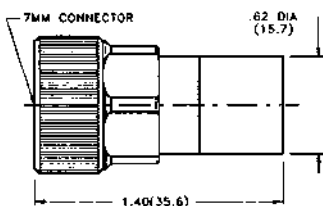

Broadband Performance DC – 18.0 GHz

DC - 18.0 GHz 2052 Series

7mm	7mm with Chain
TRM-2052-00-7MM-02	TRM-2052-0C-7MM-02

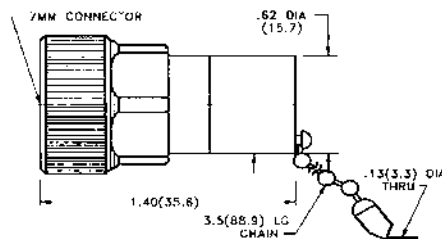
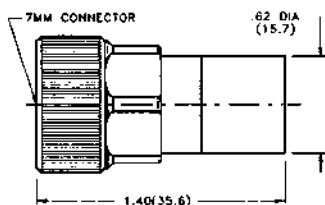

DC – 18.0 GHz – High Performance

- Precision and Broadband Model Selection
- Broad Frequency Band Coverage
- Low VSWR – 50 Ohm – High Performance
- Rugged Stainless Steel Interface Constructions

Midwest Microwave's N Type series of coaxial Terminations provide temperature stable, ruggedly built, precision performance in light weight reasonably sized packages using stainless steel connectors and housings. Input Power levels of 2 Watts is offered with low VSWR performance.



Specifications			
Series		TRM-2001	TRM-2053
Frequency, (GHz)		DC - 18.0	DC - 12.4
VSWR formula, (max.):		1.03+.005 (f GHz)	N/A
VSWR table, (max.):	Freq. (GHz)	VSWR	VSWR
	DC - 4.0	1.05	1.07
	4.0-12.4	1.09	1.12
	12.4-18.0	1.12	N/A
Nominal Impedance, (Ω)		50	
Operating Temperature, (°C)		-55 to +125	
Average Power, (W)*		2	
Finish:		Passivated Stainless Steel	

* Rated @25°C, derated linearly to 0.5W @ 125°C

DC – 18.0 GHz – Precision N Performance

DC - 18.0 GHz 2001 Series			
Male Plug	Male Plug with Chain	Female Jack	Female Jack with Chain
TRM-2001-M0-NNN-02	TRM-2001-MC-NNN-02	TRM-2001-F0-NNN-02	TRM-2001-FC-NNN-02

DC – 12.4 GHz – Broadband Performance

DC - 12.4 GHz 2053 Series			
Male Plug	Male Plug with Chain	Female Jack	Female Jack with Chain
TRM-2053-M0-NNN-02	TRM-2053-MC-NNN-02	TRM-2053-F0-NNN-02	TRM-2053-FC-NNN-02

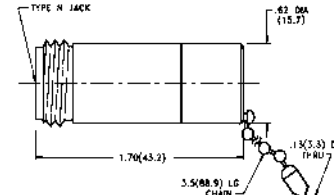
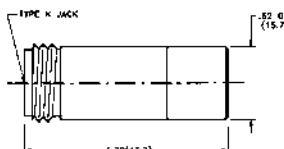
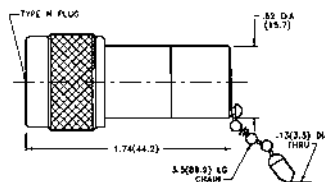
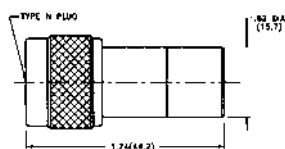

Type N Economical Types

Economical DC – 18.0 GHz Performance

- Type N
- Broad Frequency Band Coverage
- Low VSWR
- Rugged Stainless Steel Interface Construction

Midwest Microwave's Type N series of economical coaxial Terminations provide temperature stable, ruggedly built, precision performance in light weight reasonably sized packages using stainless steel connectors. The units are designed to optimize cost reduction and their performance per cost ratio is excellent. Low VSWR performance is exhibited and units are suitable for a variety of commercial operating or test systems.



Specifications			
Series		TRM-2070	TRM-2071
Frequency, (GHz)		DC - 18.0	DC - 4.0
VSWR table, (max.):	Freq. (GHz)	VSWR	VSWR
	DC - 4.0	1.25	1.25
	4.0-18.0	1.25	N/A
Nominal Impedance, (Ω)		50	
Operating Temperature, ($^{\circ}$ C)		-55 to +125	
Average Power, (W)*		2	
Finish:		Passivated Stainless Steel	

* Rated @25 $^{\circ}$ C, derated linearly to 0.5W @ 125 $^{\circ}$ C

Economical DC – 18.0 GHz

DC - 18.0 GHz 2070 Series			
N Male Plug	N Male Plug with Chain	Female Jack	Female Jack with Chain
TRM-2070-M0-NNN-07	TRM-2070-MC-NNN-072	TRM-2070-F0-NNN-07	TRM-2070-FC-NNN-0-02

Economical DC – 4.0 GHz

DC - 12.4 GHz 2071 Series			
N Male Plug	N Male Plug with Chain	Female Jack	Female Jack with Chain
TRM-2071-M0-NNN-07	TRM-2071-MC-NNN-07	TRM-2071-F0-NNN-07	TRM-2071-FC-NNN-07

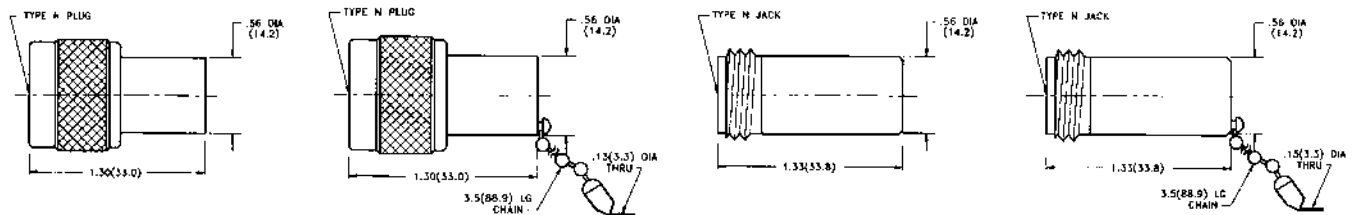



DC – 18.0 GHz – 10 Watt Performance

- DC - 12.4 and DC - 18.0 GHz Model Selection
- 10 Watts of Power Handling at 25°C
- Low VSWR – 50 Ohm – High Performance
- Rugged Stainless Steel Interface Construction

Midwest Microwave's Type N series of medium power coaxial Terminations provide temperature stable, ruggedly built, precision performance in light weight reasonably sized packages using stainless steel connectors and housings of black anodized finned aluminum for maximum heat dissipation. Input Power levels of 10 Watts is offered with low VSWR performance.

Specifications		
Series	TRM-2098	TRM-2080
Frequency, (GHz)	DC - 18.0	DC - 12.4
VSWR formula, (max.):	1.05 + 0.01 (f GHz)	
VSWR table, (max.):	Freq. (GHz)	VSWR
	DC - 12.4	1.17
	12.4-18.0	1.23
Nominal Impedance, (Ω)	50	
Average Power*, (W):	10	
Peak Power, (W):	250	
Operating Temperature, (°C)	-65 to +125	
Finish, Body :	Black Anodized Aluminum	
Finish, Connectors:	Passivated Stainless Steel	

* Rated @25°C, derated linearly to 1W @ 125°C

DC – 18.0 GHz, 10 Watts

DC - 18.0 GHz 2098 Series			
Male Plug	Male Plug with Chain	Female Jack	Female Jack with Chain
TRM-2098-M0-NNN-07	TRM-2098-MC-NNN-07	TRM-2098-F0-NNN-07	TRM-2098-FC-NNN-07

DC – 12.4 GHz, 10 Watts

DC - 12.4 GHz 2080 Series			
Male Plug	Male Plug with Chain	Female Jack	Female Jack with Chain
TRM-2080-M0-NNN-07	TRM-2080-MC-NNN-07	TRM-2080-F0-NNN-07	TRM-2080-FC-NNN-07

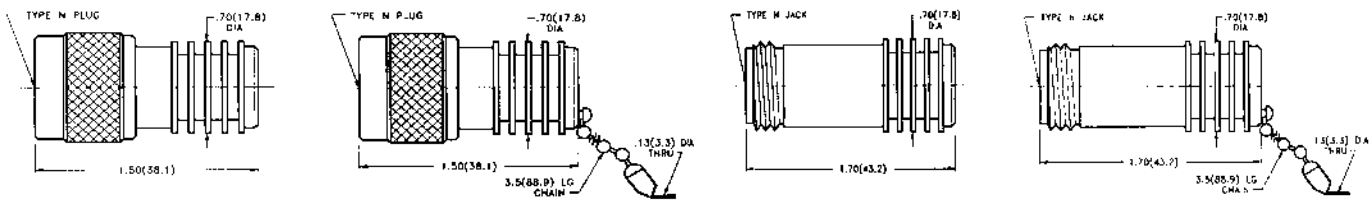

TNC Type

DC – 18.0 GHz – High Performance

- DC – 18.0 GHz and DC – 12.4 GHz Models Selection
- Broad Frequency Band Coverage
- Low VSWR
- Rugged Stainless Steel Interface Construction

Midwest Microwave's TNC Type series of coaxial Terminations provide temperature stable, ruggedly built, precision performance in light weight reasonably sized packages using stainless steel connectors and housings. Input Power levels of 2 Watts is offered with low VSWR performance.



Specifications		
Series	TRM-2108	TRM-2107
Frequency, (GHz)	DC - 18.0	DC - 12.4
VSWR table, (max.):	Freq. (GHz)	VSWR
	DC - 8.0	1.2
	8.0-18.0	1.25
Nominal Impedance, (Ω)	50	
Average Power*, (W):	2	
Peak Power, (W):	250	
Operating Temperature, ($^{\circ}$ C)	-55 to +125	
Finish:	Passivated Stainless Steel	

* Rated @25 $^{\circ}$ C, derated linearly to 0.5W @ 125 $^{\circ}$ C

DC – 18.0 GHz High Performance

DC - 18.0 GHz 2108 Series			
TNC Male Plug	TNC Male Plug with Chain	TNC Female Jack	TNC Female Jack with Chain
TRM-2108-M0-TNC-02	TRM-2108-MC-TNC-02	TRM-2108-F0-TNC-02	TRM-2108-FC-TNC-02

DC – 12.4 GHz High Performance

DC - 12.4 GHz 2107 Series			
TNC Male Plug	TNC Male Plug with Chain	TNC Female Jack	TNC Female Jack with Chain
TRM-2107-M0-TNC-02	TRM-2107-MC-TNC-02	TRM-2107-F0-TNC-02	TRM-2107-FC-TNC-02

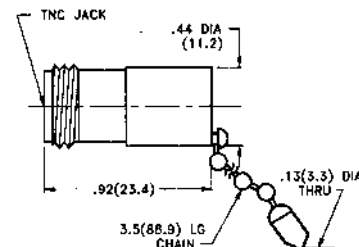
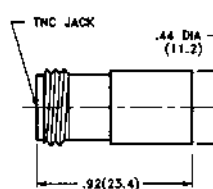
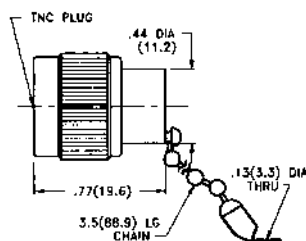
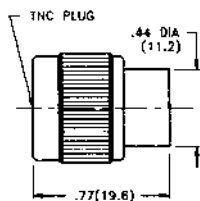

DC – 18.0 GHz – 5 Watt Performance

- Precision TNC Performance
- 5 Watt Average – 5 kW Peak Power
- Low VSWR
- Rugged Stainless Steel Interface Construction

Midwest Microwave’s TNC type series of coaxial medium power Terminations provide temperature stable, precision performance in light weight reasonably sized packages using stainless steel connectors and black anodized finned aluminum housings. The units are designed to optimize performance and reliability with low VSWR performance.



Specifications		
Series	TRM-2142	
Frequency, (GHz)	DC - 18.0	
VSWR table, (max.):	Freq. (GHz)	VSWR
	DC - 12.4	1.2
	12.4-18.0	1.3
Nominal Impedance, (Ω)	50	
Average Power*, (W):	5	
Peak Power, (W):	5	
Operating Temperature, ($^{\circ}$ C)	-55 to +125	
Finish, Body :	Black Anodized Aluminum	
Finish, Connectors:	Passivated Stainless Steel	

* Rated @25°C, derated linearly to 1W @ 125°C

5 Watts – DC – 18 GHz

DC - 18.0 GHz 2142 Series			
TNC Male Plug	TNC Male Plug with Chain	TNC Female Jack	TNC Female Jack with Chain
TRM-2142-M0-TNC-07	TRM-2142-MC-TNC-07	TRM-2142-F0-TNC-07	TRM-2142-FC-TNC-07

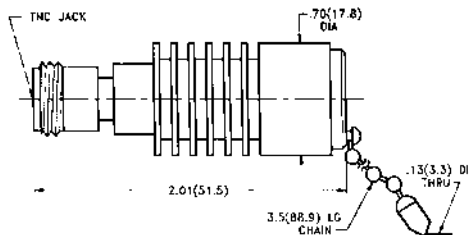
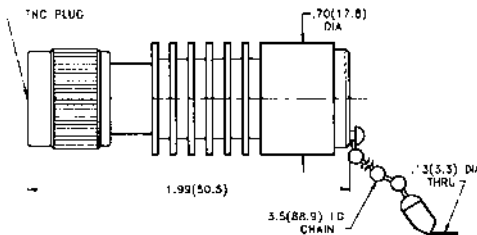
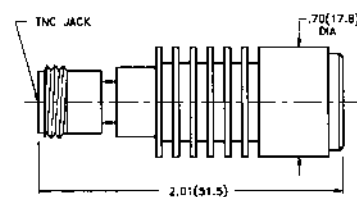
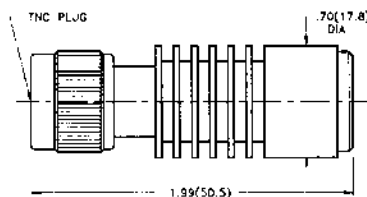

BNC Type

DC – 4.0 GHz Performance

- Economical Model Selection
- Broad Frequency Band Coverage
- Low VSWR
- 50 Ohm Performance

Midwest Microwave's BNC Type series of coaxial Terminations provide temperature stable, ruggedly performance in light weight reasonably sized packages using high quality connectors and housings. Input Power levels of 2 Watts is offered with low VSWR performance.



Specifications		
Series	TRM-2048	
Frequency, (GHz)	DC - 4.0	
VSWR table, (max.):	Freq. (GHz)	VSWR
	DC - 4.0	1.2
Nominal Impedance, (Ω)	50	
Average Power*, (W):	2	
Operating Temperature, ($^{\circ}$ C)	-55 to +125	
Finish:	Nickel Plated Brass	

* Rated @25 $^{\circ}$ C, derated linearly to 0.5W @ 125 $^{\circ}$ C

2 Watts DC – 4.0 GHz Performance

DC - 4.0 GHz 2048 Series			
BNC Male Plug	BNC Male Plug with Chain	BNC Female Jack	BNC Female Jack with Chain
TRM-2048-M0-BNC-10	TRM-2048-MC-BNC-10	TRM-2048-F0-BNC-10	TRM-2048-FC-BNC-10

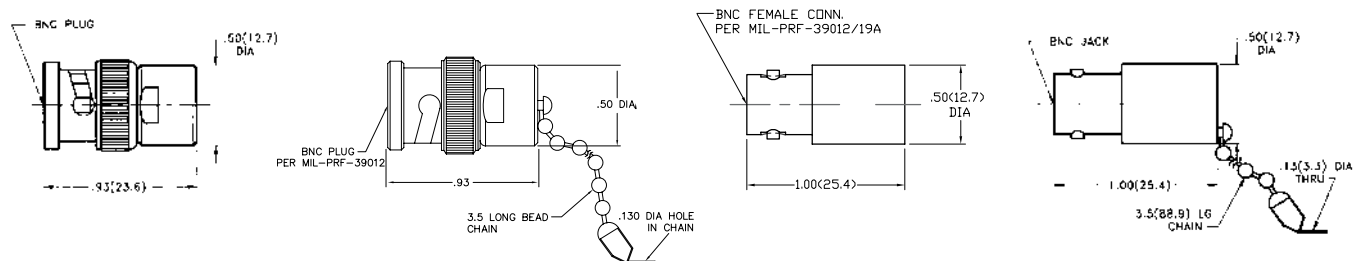

DC – 11.0 GHz Performance

- Wideband Performance
- 2W and 5W Models
- Low VSWR
- Rugged Stainless Steel Construction

Midwest Microwave's SC type series of coaxial low and medium power Terminations provide temperature stable, performance in light weight reasonably sized packages using stainless steel connectors and black anodized finned aluminum housings. The units are designed to optimize performance and reliability with low VSWR performance.



Specifications		
Series	TRM-2117	TRM-2118
Average Power, (W):	2*	5*
Peak Power, (kW):	1	5
Finish, Body:	Passivated Stainless Steel	Black Anodized Aluminum
Finish, Connectors:	Passivated Stainless Steel	Passivated Stainless Steel
Frequency, (GHz)	DC - 11.0	DC - 11.0
VSWR , (max.):	1.2	
Nominal Impedance, (Ω)	50	
Operating Temperature, (°C)	-55 to +125	

* Rated @25°C, derated linearly to 0.5W @ 125°C

** Rated @40°C, derated linearly to 1W @ 125°C

2 Watts – DC – 11.0 GHz – Performance

DC - 11.0 GHz 2117 Series			
SC Male Plug	SC Male Plug with Chain	SC Female Jack	SC Female Jack with Chain
TRM-2117-M0-SC0-02	TRM-2117-MC-SC0-02	TRM-2117-F0-SC0-02	TRM-2117-FG-SC0-02

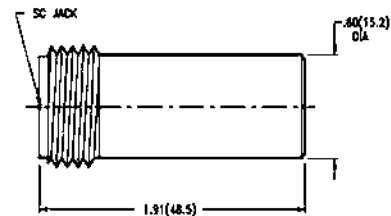
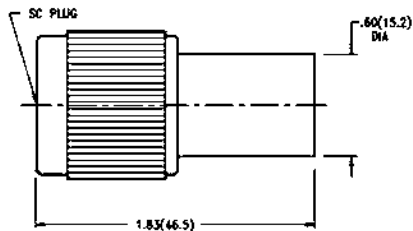

5 Watts – DC – 11.0 GHz – Performance

DC - 11.0 GHz 2118 Series			
SC Male Plug	SC Male Plug with Chain	SC Female Jack	SC Female Jack with Chain
TRM-2118-M0-SC0-07	TRM-2118-MC-SC0-07	TRM-2118-F0-SC0-07	TRM-2118-FG-SC0-07

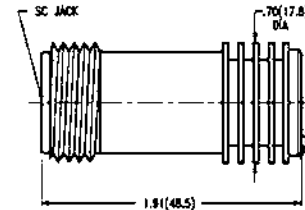
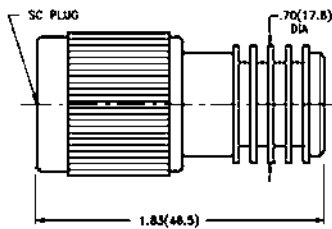

HN Type

DC – 8.0 GHz Performance

- Wideband Performance
- 2W and 5W Models
- Low VSWR
- Rugged Stainless Steel Construction

Midwest Microwave's HN type series of coaxial low and medium power Terminations provide temperature stable, performance in light weight reasonably sized packages using stainless steel connectors and black anodized finned aluminum housings. The units are designed to optimize performance and reliability with low VSWR performance and are suitable for use in military or commercial systems.



Specifications		
Series	TRM-2120	TRM-2121
Average Power, (W):	2*	5*
Finish, Body:	Passivated Stainless Steel	Black Anodized Aluminum
Finish, Connectors:	Passivated Stainless Steel	Passivated Stainless Steel
Frequency, (GHz)	DC - 8.0	DC - 8.0
VSWR, (max.):	1.25	
Nominal Impedance, (Ω)	50	
Operating Temperature, ($^{\circ}$ C)	-55 to +125	

* Rated @25 $^{\circ}$ C, derated linearly to 0.5W @ 125 $^{\circ}$ C

2 Watts – DC – 8.0 GHz Performance

DC - 8.0 GHz 2120 Series			
HN Male Plug	HN Male Plug with Chain	HN Female Jack	HN Female Jack with Chain
TRM-2120-M0-HN0-02	TRM-2120-MC-HN0-02	TRM-2120-F0-HN0-02	TRM-2120-FC-HN0-02

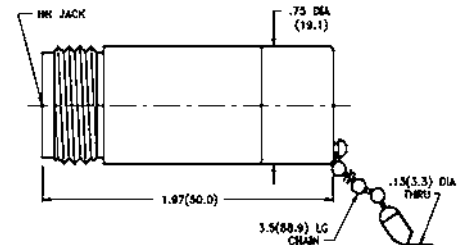
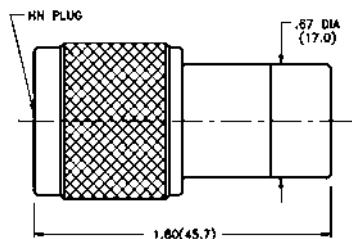

5 Watts – DC – 8.0 GHz Performance

DC - 8.0 GHz 2121 Series			
HN Male Plug	HN Male Plug with Chain	HN Female Jack	HN Female Jack with Chain
TRM-2121-M0-HN0-07	TRM-2121-MC-HN0-07	TRM-2121-F0-HN0-07	TRM-2121-FC-HN0-07

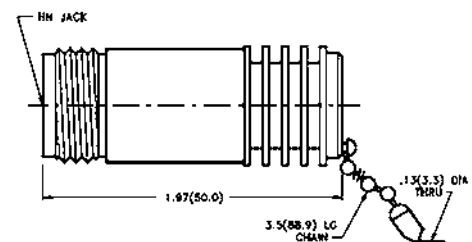
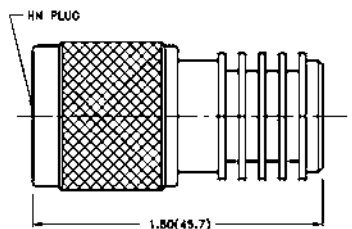

Mismatches for Testing

- SMA, N, TNC, and BMA Types
- Convenient for Phase Testing
- Small Size, Light Weight
- Bead Chain Available on all Models

Midwest Microwave's series of Plug and Jack Mismatches are conveniently offered in all of the popular connector interfaces. They are particularly useful for performing phase measurement tests. The units are available in eight standard mismatch values and special versions are available on request. All of the units are finished in passivated stainless.



Male Plug	Female Jack	Connector Type
MSM-2170-MX-SMA-02	MSM-2170-FX-SMA-02	SMA
MSM-2170-FX-BMA-02	MSM-2170-MX-BMA-02	BMA
MSM-2170-MX-NNN-02	MSM-2170-FX-NNN-02	Type N
MSM-2170-MX-TNC-02	MSM-2170-FX-TNC-02	TNC

X = Mismatch Value Dash No., select from chart below and substitute in Model No.

X Dash No.	VSWR Mismatch Value	DC – 4.0 GHz	Accuracy 4.0-18.0 GHz
- 1	1.05	± 0.05	± 0.05
- 2	1.10	± 0.05	± 0.07
- 3	1.20	± 0.05	± 0.10
- 4	1.30	± 0.05	± 0.10
- 5	1.40	± 0.05	± 0.10
- 6	1.50	± 0.05	± 0.10
- 7	1.75	± 0.05	± 0.15
- 8	2.00	± 0.10	± 0.20

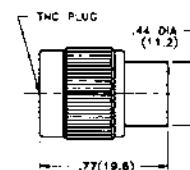
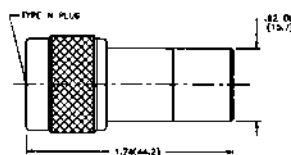
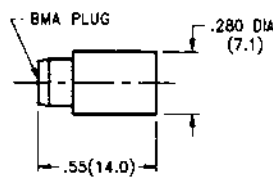
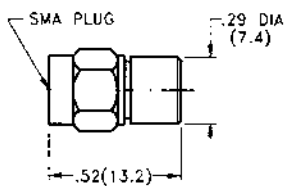

Short and Open Circuits

Short and Open Circuits for Testing

- SMA, N, TNC, and BMA Types
- Convenient for Phase Testing
- Small Size, Light Weight
- Bead Chain Available on all Models

Midwest Microwave's series of Short and Open Circuits are conveniently offered in all of the popular male and female connector interfaces. They are particularly useful for performing phase measurement tests. The units are finished in passivated stainless steel.



Short Circuit Part No.		Connector Type
Male Plug	Female Jack	
SHT-2172-M0-SMA-02	SHT-2172-F0-SMA-02	SMA
SHT-2173-F0-BMA-02	SHT-2173-M0-BMA-02	BMA
SHT-2174-M0-NNN-02	SHT-2174-F0-NNN-02	Type N
SHT-2175-M0-TNC-02	SHT-2175-F0-TNC-02	TNC

Open Circuit Part No.		Connector Type
Male Plug	Female Jack	
OPN-2182-M0-SMA-02	OPN-2182-F0-SMA-02	SMA
OPN-2183-F0-BMA-02	OPN-2183-M0-BMA-02	BMA
OPN-2184-M0-NNN-02	OPN-2184-F0-NNN-02	Type N
OPN-2185-M0-TNC-02	OPN-2185-F0-TNC-02	TNC

Notes: 1. Bead Chains are available on all units, to designate substitute a "C" for the "0" following the "M" or the "F" in Model No.

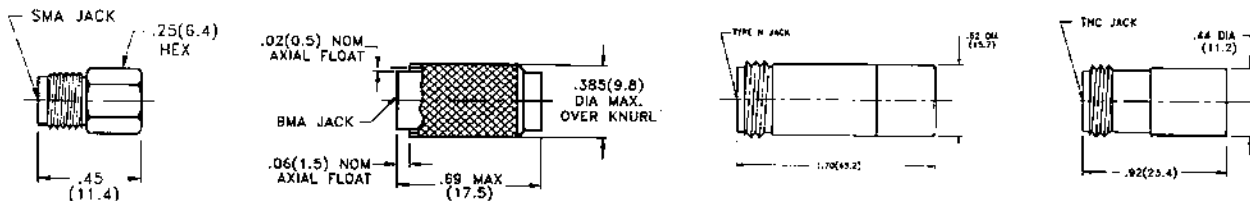



DC – 500.0 MHz Performance

- Wideband Performance
- SMA and BNC Models
- Low VSWR
- Rugged Stainless Steel Construction

Midwest Microwave's Feed Thru type series of coaxial Terminations provide temperature stable, performance in light weight reasonably sized packages using standard coaxial connector interfaces. The units are designed to allow the monitoring of a signal waveform or magnitude while terminating the signal into a matched load. By connecting a high impedance oscilloscope to the output, the signal waveform can be measured.

Specifications		
Series	TRM-2106	TRM-2050
Interface	SMA	BNC
Finish:	Passivated Stainless Steel	Nickel Plated Brass
Frequency, (GHz)	DC - 0.5	DC - 0.5
VSWR formula, (max.):	1.25	
Nominal Impedance, (Ω)	50	
Average Power*, (W):	2	
Operating Temperature, ($^{\circ}$ C)	-55 to +125	

* Rated @25 $^{\circ}$ C, derated linearly to 0.5W @ 125 $^{\circ}$ C

SMA Type

DC - 500.0 MHz 2106 Series		
Male/Female	Female/Female	Male/Male
TRM-2106-MF-SMA-02	TRM-2106-FF-SMA-02	TRM-2106-MM-SMA-02

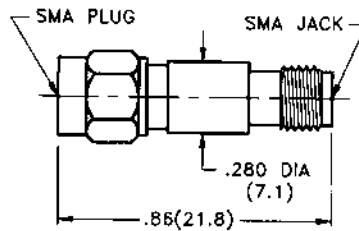

BNC Type

DC - 500.0 MHz 2050 Series		
Male/Female	Female/Female	Male/Male
TRM-2050-MF-BNC-10	TRM-2050-FF-BNC-10	TRM-2050-MM-BNC-10

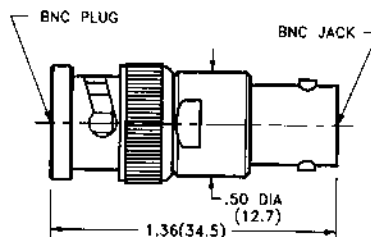

Table of Contents

DC Blocks

SMA Type	59
SMA • 7mm • N • TNC.....	60

3 Attenuators

31 Terminations

58 DC Blocks

61 Couplers

73 Power Dividers

81 Equalizers

85 Phase Shifters

87 Between Series Adapters

116 In-Series Adapters

127 Connectors

**177 QPL Approved Products &
Tools for Assembly**

200 Appendix

209 Index

18.5 GHz Performance

- Inside/Outside and Inside Only
- Greater Than 60 dB Isolation at 1kHz
- Low VSWR and Insertion Loss
- Rugged Stainless Steel Construction

Midwest Microwave's Inside/Outside and Inside only DC Blocks pass all frequencies from 500.0 MHz to 18.0 GHz while exhibiting low insertion loss and low VSWR. The inner only DC Blocks pass all frequencies from 250 MHz to 18.5 GHz while also exhibiting low insertion loss and low VSWR. Both types pose a very high insertion loss to frequencies such as 60 Hz, 120 Hz, 400 Hz, and 1 kHz. They are designed for laboratory, production line, or system use and are available in all of the popular connector interfaces. They are manufactured using rugged stainless steel and are 100% tested to assure dependable high quality performance.



Specifications		
Series	DCB-3510	DCB-3511
Configuration	Inside	Inside/ Outside
Finish, Body:	Passivated Stainless Steel	Delrin
Finish, Connectors:	Passivated Stainless Steel	Passivated Stainless Steel
Operating Temperature, (°C)	-65 to +125	-20 to +100
Frequency, (GHz)	0.25 - 18.5	0.5 - 18.0
Insertion Loss, (dB, max.):	0.5	
Isolation @ 1kHz, (dB, min.):	60	
VSWR, (max.):	1.35	
Nominal Impedance, (Ω)	50	
DC Voltage (V, max.):	200	

Inside Only

250.0 MHz – 18.5 GHz Inside Only 3510		
Male/Female	Female/Female	Male/Male
DCB-3510-MF-SMA-02	DCB-3510-FF-SMA-02	DCB-3510-MM-SMA-02

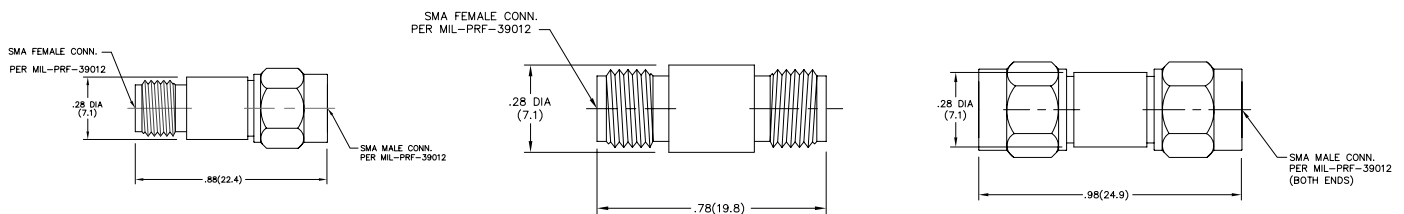

Inside / Outside

500.0 MHz – 18.0 GHz Inside/Outside 3511		
Male/Female	Female/Female	Male/Male
DCB-3511-MF-SMA-02	DCB-3511-FF-SMA-02	DCB-3511-MM-SMA-02

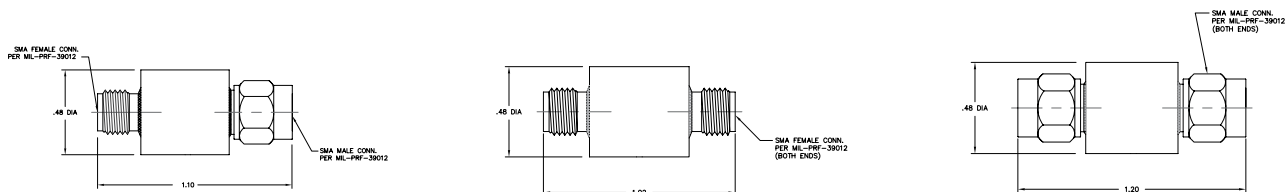

SMA • 7mm • N • TNC

Inside/Outside High Performance

- 0.1 - 12.4 GHz and 0.1 - 18.0 GHz Units
- Greater than 65 dB Isolation at 1kHz
- Low VSWR and Insertion Loss
- Rugged Stainless Steel Construction

Midwest Microwave's high performance Inside/Outside DC Blocks pass all frequencies from 100.0 MHz to 18.0 GHz while exhibiting low insertion loss and low VSWR. The units pose a very high insertion loss to frequencies such as 60 Hz, 120 Hz, 400 Hz, and 1 kHz. They are designed for laboratory, production line, or system use and are available in all of the popular connector interfaces. They are manufactured using rugged stainless steel and are 100% tested to assure dependable high quality performance.



Specifications							
Series	DCB-3537	DCB-3538	DCB-3549	DCB-3524	DCB-3525	DCB-3534	DCB-3535
Interface	SMA	SMA	7mm	N	N	TNC	TNC
Frequency, (GHz)	0.1 - 12.4	0.1 - 18.0	0.1 - 18.0	0.1 - 12.4	0.1 - 18.0	0.1 - 12.4	0.1 - 18.0
Finish, Body :	Delrin						
Finish, Connectors:	Passivated Stainless Steel						
Operating Temperature, (°C)	-20 to +100						
Insertion Loss, (dB, max.):	0.5						
Isolation @ 1kHz, (dB, min.):	65						
VSWR, (max.):	1.20 max @ 0.01 - 8.0 GHz, 1.25 max @ 8.0 - 12.4 GHz, and 1.35 max @ 12.4 - 18.0 GHz						
Nominal Impedance, (Ω)	50						
DC Voltage (V, max.):	200						

SMA Type	
100.0 MHz – 18.0 GHz	100.0 MHz – 12.4 GHz
Male/Female	Male/Female
DCB-3538-IO-SMA-02	DCB-3537-IO-SMA-02

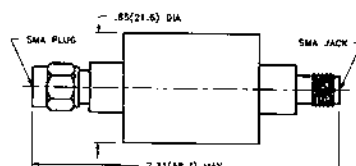

7mm	
100.0 MHz – 18.0 GHz	
Male/Female	
DCB-3549-IO-SMA-02	

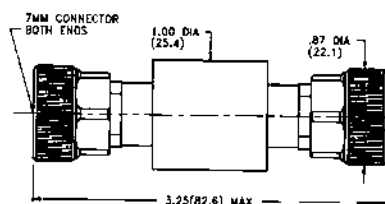

N Type	
100.0 MHz – 18.0 GHz	100.0 MHz – 12.4 GHz
Male/Female	Male/Female
DCB-3525-IO-NNN-02	DCB-3524-IO-NNN-02

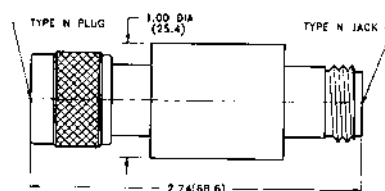

TNC Type	
100.0 MHz – 18.0 GHz	100.0 MHz – 12.4 GHz
Male/Female	Male/Female
DCB-3535-IO-TNC-02	DCB-3534-IO-TNC-02

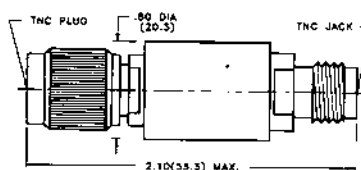

Couplers

General Information	62
Definition of Parameters	63
Directional Couplers - Octave Bandwidths	65
Directional Couplers - Ultra-Wideband	66
3 dB 90° Hybrids - Crossover Type	67
3 dB 90° Hybrids - Non-Crossover Type	68
3 dB 180° Hybrids - Crossover Type	69
3 dB 180° Hybrids - Magic T's.....	70
Directional Couplers - N & TNC.....	71
30 dB Ultra-Broadband Monitor Coupler	72

3	Attenuators
----------	--------------------

31	Terminations
-----------	---------------------

58	DC Blocks
-----------	------------------

61	Couplers
-----------	-----------------

73	Power Dividers
-----------	-----------------------

81	Equalizers
-----------	-------------------

85	Phase Shifters
-----------	-----------------------

87	Between Series Adapters
-----------	--------------------------------

116	In-Series Adapters
------------	---------------------------

127	Connectors
------------	-------------------

177	QPL Approved Products & Tools for Assembly
------------	---

200	Appendix
------------	-----------------

209	Index
------------	--------------

While every precaution has been taken to ensure accuracy and completeness herein, Emerson Network Power Connectivity Solutions assumes no responsibility, and disclaims all liability for damages resulting from use of this information or for any errors or omissions. Specifications subject to change without notice.

General Information

- 0.5 - 18 GHz High Directivity Performance
- Octave, Broadband and Ultrabroadband Frequency Coverage
- Small Size, Light Weight, Rugged Construction
- Designed to Meet Military and Space Environmental Specifications, see appendix for details

Couplers are usually four port passive devices containing two separate transmission lines, each having one port on each end that come into proximity to each other such that microwave energy propagating on one of the lines will couple to the other. The four ports are almost always matched to an impedance of 50 ohms. Midwest Microwave manufactures three basic types of couplers. Directional Couplers, 90° Hybrid Couplers, and 180° Hybrid Couplers. They are small, lightweight, broadband couplers that most often use rugged stripline circuit construction and perform extremely well over the wide temperature range of -55°C to +125°C. They are also designed to perform with low insertion loss and high isolation. Units are available in octave and multi-octave frequency bandwidths with some ultra-broadband units available covering the band of 0.5 to 18.0 GHz with a few models operating up to 26.5 GHz. They exhibit low ripple and high directivity. The 90° and 180° Hybrid Couplers are available in both crossover and non-crossover configurations. The Couplers are designed to meet the stringent environmental

requirements. Standard catalog units are available with SMA connectors with other connector types available upon special request. Some items are available off the shelf for immediate delivery or special units can be custom designed by Midwest Microwave's experienced engineering staff to accommodate unique system needs. All Midwest Couplers are completely manufactured in house and are 100% tested to insure only the highest quality performance whether for military or space use or for commercial cellular or personal communications applications.

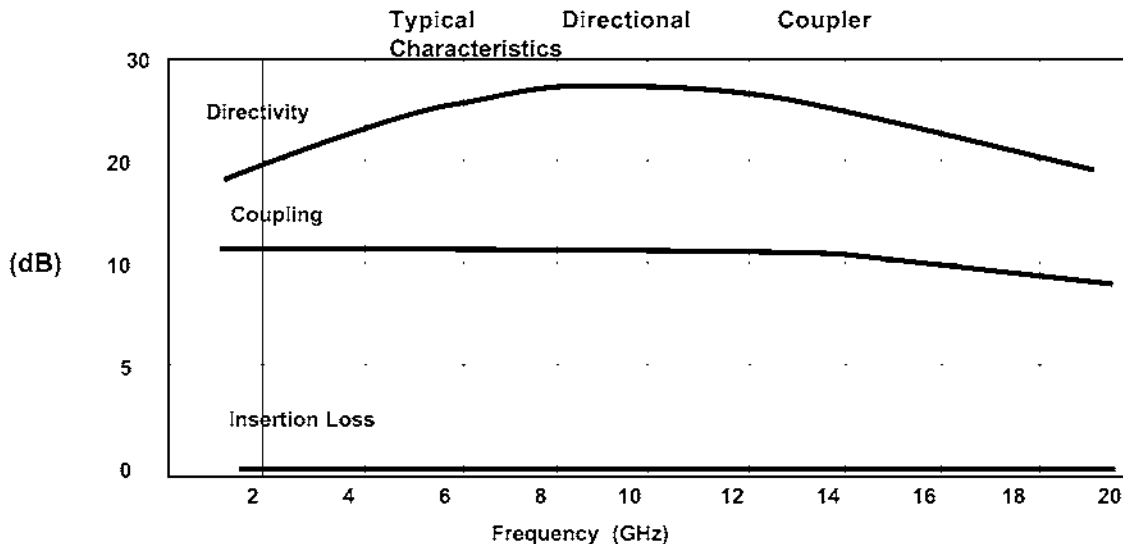

Coupler

A four port device that contains two separate transmission lines, the Primary Line (J1-J2), and the Coupled Line (J3-J4), each having one port at each end, (as designated in figure 1 below). Because of their proximity to each other, microwave energy propogating on one of the lines, couples unidirectionally to the other line causing microwave energy to appear on it.



will not receive any power in a theoretically ideal coupler, but in reality it is usually terminated to absorb any reflected power from J3. Conversely, if power were input in the opposite direction at J2, J4 would become the coupled port and J3 would become the isolated port

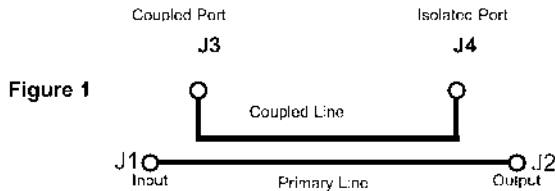

Frequency

Directional Couplers will only perform satisfactorily over a finite frequency band. Design goals are continually aimed toward broadening the frequency bandwidth as much as possible.

Primary Line

The transmission line (primary circuit) between the input port J1 and the output port J2 is called the Primary Line. It is usually the line on which the signal to be coupled or sampled is propogating.

Coupled Line

The transmission line to which the Primary Line signal is coupled is called the Coupled Line. It is usually terminated at the isolated port with a 50 ohm termination.

Coupling

The coupling of energy from the primary line to the coupled line is accomplished as follows: A portion of the microwave power input at port J1, (see Figure 1), is coupled to port J3 and the remaining power continues out through the output port J2. The amount of coupled energy will vary slightly over the frequency range of the coupler. This characteristic is known as 'ripple' and is controllable through design technique, but cannot be completely eliminated.

Coupling is expressed as follows:

$$\text{Coupling (dB)} = -10 \text{ Log } [P3/P1]$$

Note: P3 and P1 represent the microwave power levels at ports J3 and J1 respectively.

An example of a 10 dB coupler would direct 1/10 of the power input at J1 out of the coupled port at J3 and the remaining 9/10 of the power will continue to pass down the primary line to the J2 output port. The isolated port at J4

Insertion Loss

In a directional coupler, the total insertion loss from the primary line input to the primary line output is equal to the coupling loss plus resistive, dielectric and reflection losses. In an ideal coupler, where dissipative losses are ignored, the primary line loss due to the coupling effect of power going to the coupled line is expressed as follows:

$$\text{Insertion Loss (dB)} = 10 \text{ Log } [1 - P3/P1]$$

The relationship of coupling loss to coupling for an ideal (dissipationless) coupler is shown in the graph below.

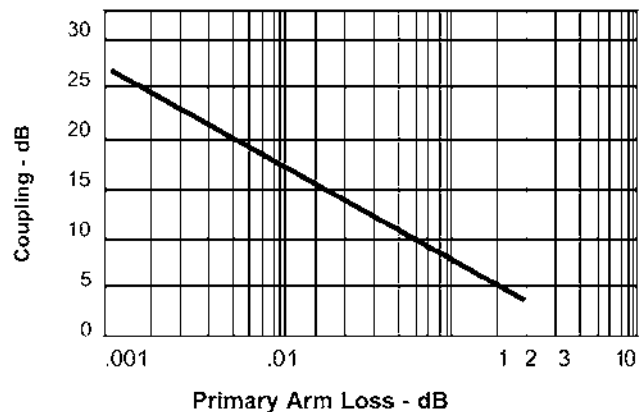

Directivity

The measure of how well the isolated port is isolated, such that the highest amount of coupled power actually gets to the coupled port. In reality, not all of the power ever does, some of the power always arrives at the isolated port. If the power at the isolated port is 20 dB below the power at the coupled port, the coupler is said to have 20 dB of directivity.

Directivity is expressed as follows:

$$\text{Directivity (dB)} = -10 \text{ Log } [P4/P3]$$

Note: Assuming that the input power is at the input port J1

Definition of Parameters

Isolation

Isolation is another way of expressing the measure of how much power is leaking to the isolated port. It is expressed as follows:

$$\text{Isolation (dB)} = -20 \text{ Log } [P4/P1]$$

It is clear that Isolation and Directivity are really measuring the same characteristic, i.e.

$$\text{Isolation (dB)} = \text{Coupling (dB)} + \text{Directivity (dB)}$$

A simple example would be that of a 10 dB coupler with 20 dB directivity which would obviously then have 30 dB of isolation. Directivity rather than isolation is usually specified on directional couplers where isolation is usually specified on Hybrid Couplers.

VSWR

Directional Couplers unfortunately possess many reflections as a result of impedance mismatches and other discontinuities contained in their circuitry usually caused by practical physical constraints imposed by system space requirements. Referring to Figure 1, a mismatch at the output port J2 or at the coupled port J3, will reduce directivity by an amount equal to the return loss (in dB) of the mismatch. It does not matter whether the mismatch is connected to the output port of the coupler J2, or is inherent in the coupler circuit itself. By measuring the directivity of a coupler which has very high directivity and low VSWR, the VSWR of the termination or load connected to the output port J2 can be determined. This is a very convenient characteristic that allows Directional Couplers to be extremely useful in measuring VSWR. Reflectometer test methods utilize this characteristic of directional couplers. The relationship between return loss (dB) and VSWR is shown graphically below.

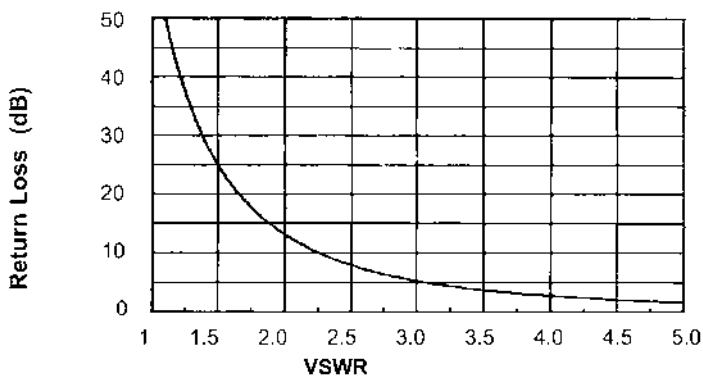

90° Hybrid Couplers

Hybrid Couplers are generally a 3 dB Directional Coupler where the coupled port output signal and the primary line output signal are out of phase with each other by 90°. Since -3 dB equates to half power, a 3 dB coupler is really a power divider that divides power equally between the primary line output port and the coupled line output port while providing a 90° phase difference between the two signals. Hybrid Couplers are available in crossover configurations, where both the primary and the coupled output ports are physically on the same side of the circuit, and in non-crossover configurations where the coupled output port is physically on the opposite side of the primary output port. This location option is purely for mechanical convenience. 90° Hybrid Couplers are also known as Quadrature Hybrids because the 90° phase difference is called a Quadrant. It may also be noted that any one of the four ports can be designated the input port and the same relationship between ports will remain. This occurs because electrically as well as mechanically a 90° Hybrid Coupler is symmetrical. The diagram below describes both the crossover and non-crossover 90° Hybrid Couplers.

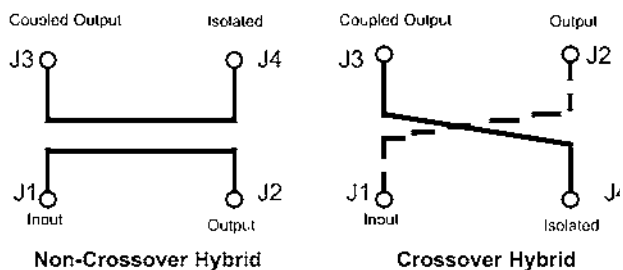

Figure 2

180° Hybrid Couplers

When a 90° Phase Shifter is added in front of the output port J2, microwave power input at the sum (S) port will divide equally in amplitude between port J1 and port J2 and will be in phase with each other. The difference (D) being the isolated port. If the power is input at the difference (D) port, the power will divide equally in amplitude, however port J1 and port J2 will now have a 180° phase difference and the sum (S) port will become the isolated port. In addition when simultaneous coherent microwave signal inputs are supplied to ports J1 and J2, the S port will produce a signal that is the sum (S) of the two input signals, and the D port will produce a signal that is the difference (D) between the two input signals.

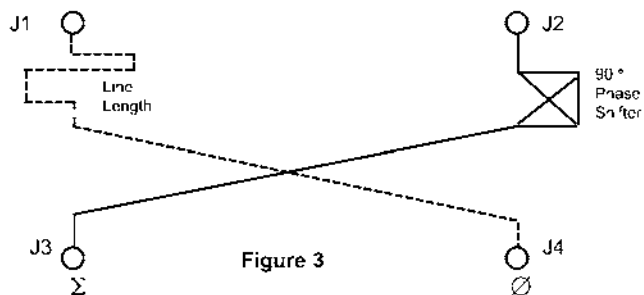

Figure 3

SMA Miniature High Performance

- Full Octave Frequency Band Performance
- Low VSWR – High Directivity
- Small Light Weight
- 50 Ohms Nominal Impedance



Midwest Microwave's SMA miniature series of high performance directional couplers are small, lightweight, ruggedly constructed stripline units that possess inherently low insertion loss and VSWR with high directivity. Units are available in octave frequency bandwidths covering the entire range of 0.5-18.0 GHz.

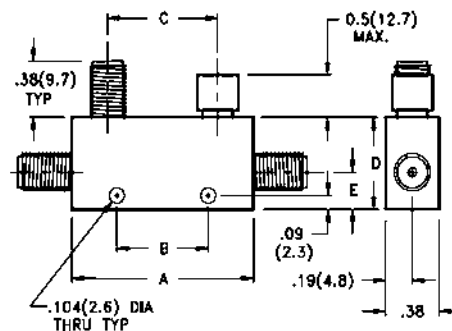

Electrical Specifications

Frequency Range GHz	Case Style	Part Number	Nominal Coupling dB	Coupling Accuracy ± dB (max.)	Frequency Sensitivity ± dB (max.)	Insertion Loss dB (max.)	Directivity dB (min.)	VSWR (max.)	Average Power W (max.)	Reflected Power W (max.)	Peak Power kW (max.)
0.5 - 1.0	4	CPL-5210-06-SMA-79	6	1.0	0.60	0.15	25	1.10	50	4	4
0.5 - 1.0	4	CPL-5210-10-SMA-79	10	1.0	0.75	0.15	25	1.10	50	10	4
0.5 - 1.0	4	CPL-5210-20-SMA-79	20	1.0	0.75	0.15	25	1.10	50	50	4
0.5 - 1.0	4	CPL-5210-30-SMA-79	30	1.0	0.60	0.15	25	1.10	50	50	4
1.0 - 2.0	3	CPL-5211-06-SMA-79	6	1.0	0.60	0.20	25	1.15	50	4	4
1.0 - 2.0	3	CPL-5211-10-SMA-79	10	1.0	0.75	0.20	25	1.15	50	10	4
1.0 - 2.0	3	CPL-5211-20-SMA-79	20	1.0	0.75	0.20	25	1.15	50	50	4
1.0 - 2.0	3	CPL-5211-30-SMA-79	30	1.0	0.75	0.20	25	1.15	50	50	4
2.0 - 4.0	2	CPL-5212-06-SMA-79	6	1.0	0.60	0.20	22	1.15	50	4	4
2.0 - 4.0	2	CPL-5212-10-SMA-79	10	1.0	0.75	0.20	22	1.15	50	10	4
2.0 - 4.0	2	CPL-5212-20-SMA-79	20	1.0	0.75	0.20	22	1.15	50	50	4
2.0 - 4.0	2	CPL-5212-30-SMA-79	30	1.0	0.75	0.20	22	1.15	50	50	4
2.6 - 5.2	1	CPL-5213-06-SMA-79	6	1.0	0.60	0.25	20	1.25	50	4	4
2.6 - 5.2	1	CPL-5213-10-SMA-79	10	1.0	0.75	0.25	20	1.25	50	10	4
2.6 - 5.2	1	CPL-5213-20-SMA-79	20	1.0	0.75	0.25	20	1.25	50	50	4
2.6 - 5.2	1	CPL-5213-30-SMA-79	30	1.0	0.75	0.25	20	1.25	50	50	4
4.0 - 8.0	1	CPL-5214-06-SMA-79	6	1.0	0.50	0.35	20	1.25	50	4	4
4.0 - 8.0	1	CPL-5214-10-SMA-79	10	1.0	0.50	0.35	20	1.25	50	10	4
4.0 - 8.0	1	CPL-5214-20-SMA-79	20	1.0	0.50	0.35	20	1.25	50	50	4
4.0 - 8.0	1	CPL-5214-30-SMA-79	30	1.0	0.50	0.35	20	1.25	50	50	4
7.0 - 12.4	1	CPL-5215-06-SMA-79	6	1.0	0.40	0.40	17	1.35	50	4	4
7.0 - 12.4	1	CPL-5215-10-SMA-79	10	1.0	0.50	0.40	17	1.35	50	10	4
7.0 - 12.4	1	CPL-5215-20-SMA-79	20	1.0	0.50	0.30	17	1.35	50	50	4
7.0 - 12.4	1	CPL-5215-30-SMA-79	30	1.0	0.50	0.30	17	1.35	50	50	4
7.0 - 18.0	1	CPL-5216-06-SMA-79	6	1.0	0.50	0.50	15	1.35	50	4	4
7.0 - 18.0	1	CPL-5216-10-SMA-79	10	1.0	0.50	0.50	15	1.40	50	10	4
7.0 - 18.0	1	CPL-5216-20-SMA-79	20	1.0	0.75	0.50	15	1.45	50	50	4
7.0 - 18.0	1	CPL-5216-30-SMA-79	30	1.0	0.75	0.50	15	1.45	50	50	4
12.4 - 18.0	1	CPL-5217-06-SMA-79	6	1.0	0.40	0.50	15	1.35	50	4	2
12.4 - 18.0	1	CPL-5217-10-SMA-79	10	1.0	0.50	0.50	15	1.45	50	10	2
12.4 - 18.0	1	CPL-5217-20-SMA-79	20	1.0	0.50	0.50	15	1.45	50	50	2
12.4 - 18.0	5	CPL-5217-30-SMA-79	30	1.0	0.50	0.50	15	1.45	50	50	2

Note: TNC or Type N output connectors are available by substituting "TNC" or "NNN" for "SMA" in the Model Number. See next page for dimensions.

Directional Couplers • Ultra-Wideband

Ultra-Wideband Performance

- Full 0.5 – 18.0 GHz Bandwidth Units
- Low VSWR – High Directivity
- Rugged Stripline Construction
- 50 Ohms Nominal Impedance



Midwest Microwave's SMA miniature series of Ultra-Wideband high performance directional couplers are small, lightweight, components that perform extremely well over multi-octave and Ultra-Wideband frequencies covering the entire range of 0.5 - 18.0 GHz.

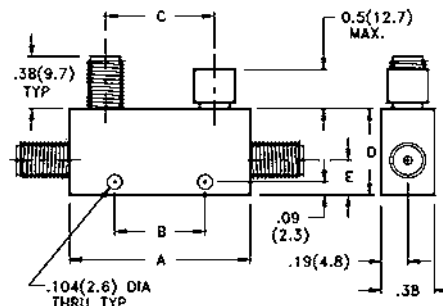

Electrical Specifications

Frequency Range GHz	Case Style	Part Number	Nominal Coupling dB	Coupling Accuracy ± dB (max.)	Frequency Sensitivity ± dB (max.)	Insertion Loss dB (max.)	Directivity dB (min.)	VSWR (max.)	Average Power *** W (max.)	Peak Power kW (max.)
0.5 - 2.0	6	CPL-5220-06-SMA-79	6	1.0	0.50	0.4	22	1.20	50	3
0.5 - 2.0	6	CPL-5220-10-SMA-79	10	1.0	0.50	0.4	22	1.20	50	3
0.5 - 2.0	6	CPL-5220-16-SMA-79	16	1.0	0.50	0.4	22	1.20	50	3
0.5 - 2.0	6	CPL-5220-20-SMA-79	20	1.0	0.50	0.4	22	1.20	50	3
1.0 - 4.0	6	CPL-5221-06-SMA-79	6	1.0	0.50	0.5	22	1.25	50	4
1.0 - 4.0	6	CPL-5221-10-SMA-79	10	1.0	0.50	0.5	22	1.25	50	4
1.0 - 4.0	6	CPL-5221-16-SMA-79	16	1.0	0.50	0.5	22	1.25	50	4
1.0 - 4.0	6	CPL-5221-20-SMA-79	20	1.0	0.50	0.5	22	1.25	50	4
2.0 - 8.0	7	CPL-5222-06-SMA-79	6	1.0	0.50	0.5	20	1.25	50	3
2.0 - 8.0	7	CPL-5222-10-SMA-79	10	1.0	0.50	0.5	20	1.25	50	3
2.0 - 8.0	7	CPL-5222-16-SMA-79	16	1.0	0.50	0.5	20	1.25	50	3
2.0 - 8.0	7	CPL-5222-20-SMA-79	20	1.0	0.50	0.5	20	1.25	50	3
6.0 - 18.0	1	CPL-5226-06-SMA-79	6	1.0	0.50	0.6	15	1.40	50	3
6.0 - 18.0	1	CPL-5226-10-SMA-79	10	1.0	0.50	0.6	15	1.40	50	3
6.0 - 18.0	1	CPL-5226-16-SMA-79	16	1.0	0.50	0.6	15	1.40	50	3
6.0 - 18.0	1	CPL-5226-20-SMA-79	20	1.0	0.50	0.6	15	1.40	50	3
0.5 - 18.0	6	CPL-5230-10-SMA-79	10*	1.5	1.00	1.0	15**	1.50	50	3
0.5 - 18.0	6	CPL-5230-16-SMA-79	16*	1.5	1.00	1.0	15**	1.50	50	3
0.5 - 18.0	6	CPL-5230-20-SMA-79	20*	1.5	1.00	1.0	15**	1.50	50	3
2.0 - 18.0	7	CPL-5232-06-SMA-79	6*	1.0	0.50	0.8	15**	1.40	20	3
2.0 - 18.0	7	CPL-5232-10-SMA-79	10*	1.0	0.50	0.8	15**	1.40	20	3
2.0 - 18.0	7	CPL-5232-16-SMA-79	16*	1.0	0.50	0.8	15**	1.40	20	3
2.0 - 18.0	7	CPL-5232-20-SMA-79	20*	1.0	0.50	0.8	15**	1.40	20	3

* Coupling is referenced to the output port. ** Directivity is 12 dB from 12.4 - 18.0 GHz. *** At input port.

Mechanical Specifications – inches (mm)

Case Style	A	B	C	D	E	Weight Oz	Gr
1	1.00 (25.4)	N/A	0.50 (12.7)	0.50 (12.7)	0.22 (5.6)	0.60	17.0
2	1.16 (29.4)	0.34 (8.7)	0.66 (16.7)	0.50 (12.7)	0.22 (5.6)	0.64	18.2
3	1.78 (45.2)	0.94 (23.8)	1.28 (32.5)	0.50 (12.7)	0.22 (5.6)	0.82	23.2
4	3.00 (76.2)	1.00 (25.5)	2.50 (63.5)	0.75 (19.1)	0.31 (7.9)	1.50	43.0
5	1.00 (25.4)	N/A	0.50 (12.7)	0.63 (15.9)	0.22 (5.6)	0.67	19.0
6	3.50 (88.9)	2.00 (50.8)	3.00 (76.2)	0.75 (19.1)	0.25 (6.3)	1.75	49.6
7	2.00 (50.8)	0.95 (24.2)	1.50 (38.1)	0.63 (16.0)	0.22 (5.6)	1.30	36.9

Note: TNC or Type N connectors are available by substituting "TNC" or "NNN" for "SMA" in the Model Number.

250 MHz – 18.0 GHz High Performance

- Low VSWR – High Isolation
- 90° Quadrature Phase
- Small Size, Light Weight
- 50 Ohm Nominal Impedance

Midwest Microwave's series of high performance 90° Crossover Hybrid Couplers provide temperature stable, low VSWR, high isolation, broadband performance in a compact light weight package size. All models use rugged stripline construction with a variety of stainless steel connectors. The crossover feature, putting both outputs on the same side of the unit is convenient for most systems where space and weight is a premium.

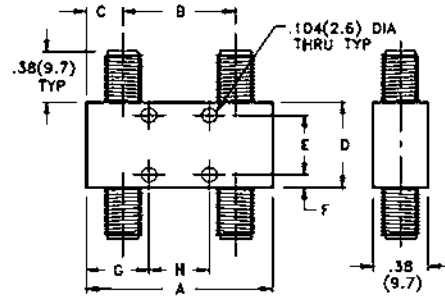

Electrical Specifications

Frequency Range GHz	Case Style	Part Number	Amplitude Balance ± dB (max.)	Insertion Loss dB (max.)	Isolation dB (min.)	VSWR (max.)	Average Power W (max.)	Peak Power kW (max.)
Octave Bandwidth Types								
0.25-0.5	3	HYB-5309-X3-SMA-79	0.50	0.20	25	1.20	50	3
0.5-1.0	3	HYB-5310-X3-SMA-79	0.50	0.20	25	1.20	50	3
1.0-2.0	2	HYB-5311-X3-SMA-79	0.50	0.20	22	1.20	50	3
2.0-4.0	1	HYB-5312-X3-SMA-79	0.50	0.25	22	1.25	50	3
2.6-5.2	1	HYB-5313-X3-SMA-79	0.50	0.30	20	1.25	50	3
4.0-8.0	1	HYB-5314-X3-SMA-79	0.50	0.30	20	1.35	50	3
7.0-12.4	1	HYB-5315-X3-SMA-79	0.50	0.20	18	1.35	30	3
12.4-18.0	1	HYB-5317-X3-SMA-79	0.50	0.60	15	1.45	30	3
Multi-Octave Bandwidth Types								
0.5-2.0	7	HYB-5320-X3-SMA-79	0.50	0.60	24	1.30	30	3
0.5-4.0	6	HYB-5321-X3-SMA-79	0.75	1.20	20	1.50	30	3
2.0-8.0	3	HYB-5322-X3-SMA-79	0.50	0.75	17	1.30	30	3
2.0-12.4	4	HYB-5325-X3-SMA-79	0.75	1.20	17	1.45	30	3
6.0-18.0	1	HYB-5326-X3-SMA-79	0.50	0.60	15	1.45	30	3
2.0-18.0	4	HYB-5332-X3-SMA-79	0.75	1.50	17	1.50	30	3

Mechanical Specifications – inches (mm)

Case Style	A	B	C	D	E	F	G	H	Weight	
									Oz	Gr
1	1.00 (25.4)	0.50 (12.7)	0.25 (6.3)	0.50 (12.7)	0.312 (7.9)	0.093 (2.4)	0.50 (12.7)	N/A	0.60	17
2	2.00 (50.8)	1.50 (38.1)	0.25 (6.3)	0.50 (12.7)	0.312 (7.9)	0.093 (2.4)	1.00 (25.4)	N/A	0.64	18
3	2.00 (50.8)	1.50 (38.1)	0.25 (6.3)	1.00 (25.4)	0.812 (22.1)	0.093 (2.4)	1.00 (25.4)	N/A	0.82	23
4	2.70 (68.6)	2.20 (55.9)	0.25 (6.3)	1.06 (26.9)	0.86 (21.8)	0.10 (2.54)	0.84 (21.3)	1.030 (26.2)	2.30	65
5	2.70 (68.6)	2.20 (55.9)	0.25 (6.3)	0.86 (21.8)	N/A	0.43 (10.9)	0.58 (14.7)	1.560 (39.6)	2.70	75
6	7.00 (177.8)	6.10 (155.0)	0.45 (11.4)	1.50 (38.1)	1.180 (30.0)	0.16 (4.1)	2.25 (57.2)	2.500 (63.5)	8.00	227
7	5.58 (141.7)	5.00 (127.0)	0.29 (7.4)	0.70 (17.8)	N/A	0.35 (8.9)	0.08 (2.0)	5.420 (137.7)	2.35	67

Note: TNC or Type N output connectors are available by substituting "TNC" or "NNN" for "SMA" in the Model Number.

3 dB 90° Hybrids – Non-Crossover Type

250 MHz – 18.0 GHz High Performance

- Low VSWR – High Isolation
- 90° Quadrature Phase
- Small Size, Light Weight
- 50 Ohm Nominal Impedance

Midwest Microwave's series of high performance 90° Non-Crossover Hybrid Couplers are identical to the crossover type except that the output ports are on opposite sides of the unit. The non-crossover feature, putting the outputs on opposite sides of the unit is convenient for some situations where it is convenient and precious space and weight can be conserved.

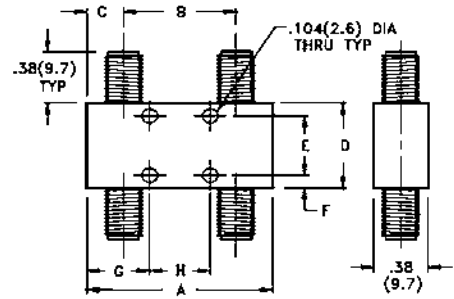

Electrical Specifications

Frequency Range GHz	Case Style	Part Number	Amplitude Balance \pm dB (max.)	Insertion Loss dB (max.)	Isolation dB (min.)	VSWR (max.)	Average Power W (max.)	Peak Power kW (max.)
Octave Bandwidth Types								
0.25-0.5	3	HYB-5309-03-SMA-79	0.5	0.20	25	1.20	50	3
0.5-1.0	3	HYB-5310-03-SMA-79	0.5	0.20	25	1.20	50	3
1.0-2.0	2	HYB-5311-03-SMA-79	0.5	0.20	22	1.20	50	3
2.0-4.0	1	HYB-5312-03-SMA-79	0.5	0.25	22	1.25	50	3
2.6-5.2	1	HYB-5313-03-SMA-79	0.5	0.30	20	1.25	50	3
4.0-8.0	1	HYB-5314-03-SMA-79	0.5	0.30	20	1.25	50	3
7.0-12.4	1	HYB-5315-03-SMA-79	0.5	0.50	18	1.35	30	3
12.4-18.0	1	HYB-5317-03-SMA-79	0.5	0.60	15	1.45	30	3
Multi-Octave Bandwidth Types								
0.5-2.0	7	HYB-5320-03-SMA-79	0.5	0.60	24	1.30	30	3
2.0-8.0	2	HYB-5322-03-SMA-79	0.5	0.75	17	1.30	30	3
6.0-18.0	1	HYB-5326-03-SMA-79	0.5	0.60	15	1.45	30	3

Mechanical Specifications – inches (mm)

Case Style	A	B	C	D	E	F	G	H	Weight	
									Oz	Gr
1	1.00 (25.4)	0.50 (12.7)	0.25 (6.3)	0.50 (12.7)	0.312 (7.9)	0.093 (2.4)	0.50 (12.7)	N/A	0.60	17
2	2.00 (50.8)	1.50 (38.1)	0.25 (6.3)	0.50 (12.7)	0.312 (7.9)	0.093 (2.4)	1.00 (25.4)	N/A	0.64	18
3	2.00 (50.8)	1.50 (38.1)	0.25 (6.3)	1.00 (25.4)	0.812 (22.1)	0.093 (2.4)	1.00 (25.4)	N/A	0.82	23
7	5.58 (141.7)	5.00 (127.0)	0.29 (7.4)	0.70 (17.8)	N/A	0.350 (8.9)	0.80 (2.0)	5.420 (137.7)	2.35	67

Note: TNC or Type N connectors are available by substituting "TNC" or "NNN" for "SMA" in the Model Number.

Excellent Phase and Amplitude Balance

- 500.0 MHz to 18.0 GHz Performance
- 0° or 180° Phase Difference
- Low VSWR – High Isolation
- Rugged Stripline Construction
- 50 Ohm Nominal Impedance



Midwest Microwave's series of 3 dB 180° Hybrid Couplers may be used as a power divider or combiner. A microwave signal applied at the sum (Σ) port will result in two equal amplitude, in phase signals at the output ports. Conversely, a microwave signal applied at the difference (Δ) port will result in two equal amplitude but 180° out of phase signals at the output ports.

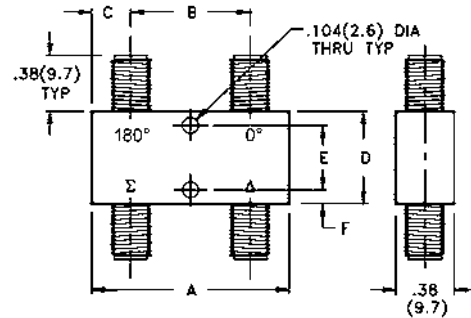

Electrical Specifications

Frequency Range GHz	Case Style	Part Number	Amplitude Balance \pm dB (max.)	Insertion Loss dB (max.)	Isolation dB (min.)	VSWR (max.)	Phase Balance \pm ° (max.)	Average Power W (max.)	Peak Power kW (max.)
0.5-1.0	1	HYB-5410-X3-SMA-79	0.5	0.40	25	1.30	10	30	3
1.0-2.0	2	HYB-5411-X3-SMA-79	0.5	0.50	25	1.35	10	30	3
2.0-4.0	3	HYB-5412-X3-SMA-79	0.5	0.70	22	1.35	10	30	3
2.6-5.2	4	HYB-5413-X3-SMA-79	0.5	0.70	20	1.35	8	30	3
4.0-8.0	4	HYB-5414-X3-SMA-79	0.5	0.70	20	1.35	8	30	3
4.0-12.4	5	HYB-5423-X3-SMA-79	0.6	1.00	17	1.50	6	30	3
7.0-12.4	6	HYB-5415-X3-SMA-79	0.5	0.80	17	1.45	6	30	3
7.0-18.0	6	HYB-5416-X3-SMA-79	0.6	1.20	14	1.70	6	30	3
12.4-18.0	6	HYB-5417-X3-SMA-79	0.6	1.20	12	1.70	6	30	3

Mechanical Specifications – inches (mm)

Case Style	A	B	C	D	E	F	Weight	
							Oz	Gr
1	3.25 (82.6)	2.5 (63.5)	0.50 (12.7)	1.25 (31.8)	1.00 (25.4)	0.13 (3.2)	2.8	70
2	2.00 (50.8)	1.25 (31.8)	0.50 (12.7)	1.25 (31.8)	1.00 (25.4)	0.13 (3.2)	2.0	47
3	1.44 (36.5)	0.69 (17.5)	0.38 (9.7)	1.25 (31.8)	1.00 (25.4)	0.13 (3.2)	1.5	38
4	1.25 (31.8)	0.50 (12.7)	0.38 (9.7)	1.25 (31.8)	1.00 (25.4)	0.13 (3.2)	1.5	38
5	1.50 (38.1)	0.75 (19.1)	0.38 (9.7)	1.00 (25.4)	0.75 (19.1)	0.13 (3.2)	1.2	34
6	1.25 (31.8)	0.50 (12.7)	0.38 (9.7)	1.00 (25.4)	0.75 (19.1)	0.13 (3.2)	1.1	31

Note: TNC or Type N output connectors are available by substituting "TNC" or "NNN" for "SMA" in the Model Number.

3 dB 180° Hybrids – Magic T's

1.0 – 18.0 GHz – Ultrabroadband Performance

- High Isolation
- Excellent Phase and Amplitude Balance
- Rugged Stripline Construction
- 50 Ohm Nominal Impedance

Midwest Microwave's series of high performance 180° Hybrid Couplers (Magic T's) provide an important function in any system where power combining or division is required. A signal applied at the sum (Σ) port will divide into two equal amplitude, in phase signals at the output ports. Conversely, a signal applied at the difference (Δ) port will result in two equal amplitude but 180° out of phase signals at the output ports. In addition, if two coherent signals are simultaneously applied at the output ports, the vectoral sum of those two signals will appear at the sum (Σ) port and the vectoral difference between the two signals will appear at the difference (Δ) port.

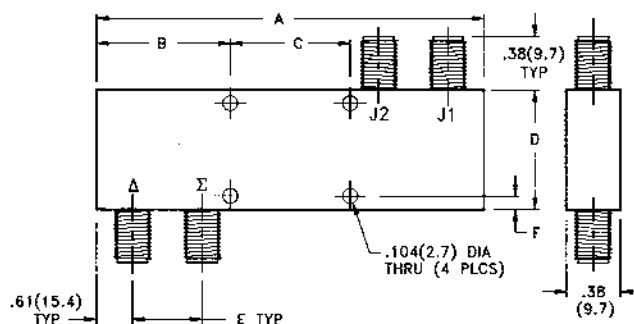

Electrical Specifications

Frequency Range GHz	Case Style	Part Number	Amplitude Balance \pm dB (max.)	Insertion Loss dB (max.)	Isolation dB (min.)	VSWR (max.)	Average Power W (max.)	Peak Power kW (max.)
2.0-8.0	1	HYB-5422-T3-SMA-79	0.5	2.3	18	1.6	30	3
2.0-12.4	3	HYB-5425-T3-SMA-79	0.7	2.3	15	2.0	30	3
1.0-12.4	2	HYB-5427-T3-SMA-79	1.0	2.5	15	2.0	30	3
1.0-18.0	2	HYB-5431-T3-SMA-79	1.5	4.5	12	2.5	20	2
2.0-18.0	3	HYB-5432-T3-SMA-79	1.0	4.0	12	2.0	20	2

Mechanical Specifications – inches (mm)

Case Style	A	B	C	D	E	F	Weight	
							Oz	Gr
1	3.04 (77.2)	0.093 (2.4)	N/A	1.35 (34.3)	0.53 (13.5)	0.67 (17.0)	2.8	78
2	6.13 (155.6)	2.06 (52.4)	2.00 (50.8)	2.50 (63.5)	0.75 (19.1)	0.093 (2.4)	9.5	270
3	3.91 (99.3)	1.96 (49.7)	N/A	2.50 (63.5)	0.75 (19.1)	0.093 (2.4)	5.4	152

Note: TNC or Type N connectors are available by substituting "TNC" or "NNN" for "SMA" in the Model Number.

500 Watt High Performance

- 500.0 MHz to 18.0 GHz Frequency Range
- Low VSWR – High Directivity
- 500 Watt High Power Capability
- Individually Calibrated
- 50 Ohm Nominal Impedance

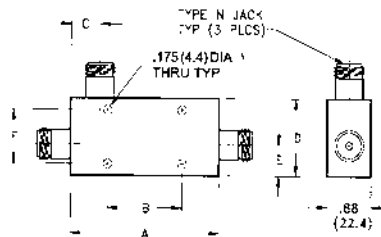

Midwest Microwave’s series of High Power Directional Couplers are useable for system or testing where flat frequency response over extended bandwidths is required. They possess high directivity and will withstand high input power under extreme environmental conditions. Standard units have stainless steel Type N female connectors but are also available with TNC connectors.

Electrical Specifications

Frequency Range GHz	Case Style	Part Number	Nominal Coupling dB	Coupling Accuracy ± dB (max.)	Frequency Sensitivity ± dB (max.)	Insertion Loss dB (max.)	Directivity dB (min.)	VSWR (max.)	Average Power W (max.)	Reflected Power W (max.)	Peak Power kW (max.)
0.5-1.0	1	CPL-5044-10-NNN-79	10	1.00	0.75	0.20	25	1.15	200	50	10
0.5-1.0	1	CPL-5044-20-NNN-79	20	1.00	0.75	0.20	25	1.15	500	500	10
0.5-1.0	2	CPL-5044-30-NNN-79	30	1.00	0.75	0.20	25	1.15	500	500	10
1.0-2.0	3	CPL-5045-10-NNN-79	10	1.00	0.75	0.20	25	1.15	200	50	10
1.0-2.0	3	CPL-5045-20-NNN-79	20	1.00	0.75	0.20	25	1.15	500	500	10
1.0-2.0	4	CPL-5045-30-NNN-79	30	1.00	0.75	0.20	25	1.15	500	500	10
2.0-4.0	3	CPL-5046-10-NNN-79	10	1.00	0.75	0.20	25	1.15	200	50	10
2.0-4.0	3	CPL-5046-20-NNN-79	20	1.00	0.75	0.20	25	1.15	500	500	10
2.0-4.0	4	CPL-5046-30-NNN-79	30	1.00	0.75	0.20	25	1.15	500	500	10
4.0-10.0	5	CPL-5047-10-NNN-79	10	1.00	0.75	0.25	20*	1.20	200	50	10
4.0-10.0	5	CPL-5047-20-NNN-79	20	1.00	0.75	0.25	20*	1.20	500	500	10
4.0-10.0	6	CPL-5047-30-NNN-79	30	1.00	0.75	0.25	20*	1.20	500	500	10
7.0-12.4	7	CPL-5048-10-NNN-79	10	0.75	0.75	0.40	15	1.50	200	50	10
7.0-12.4	7	CPL-5048-20-NNN-79	20	0.75	0.75	0.40	15	1.50	500	500	10
7.0-12.4	7	CPL-5048-30-NNN-79	30	0.75	0.75	0.40	15	1.50	500	500	10

Note: Substitute NNN in the part number with TNC for TNC models.

* Directivity is 17 dB from 8.0 - 10.0 GHz.

Mechanical Specifications – inches (mm)

Case Style	A	B	C	D	E	F	Weight	
							Lbs.	Kg
1	6.25 (158.8)	3.00 (76.2)	0.51 (13.0)	2.13 (54.0)	0.87 (22.1)	1.687 (42.9)	1.2	0.52
2	6.25 (158.8)	3.00 (76.2)	0.51 (13.0)	2.13 (54.0)	0.69 (17.5)	1.687 (42.9)	1.2	0.52
3	4.10 (104.1)	1.09 (27.7)	0.50 (12.7)	2.13 (54.0)	0.87 (22.1)	1.687 (42.9)	1.0	0.45
4	4.10 (104.1)	1.09 (27.7)	0.50 (12.7)	2.13 (54.0)	0.69 (17.5)	1.687 (42.9)	1.0	0.45
5	5.10 (129.5)	2.00 (50.8)	0.66 (16.8)	2.13 (54.0)	0.57 (14.5)	1.687 (42.9)	1.1	0.50
6	5.10 (129.5)	2.00 (50.8)	0.57 (14.5)	2.13 (54.0)	0.69 (17.5)	1.687 (42.9)	1.1	0.50
7	2.50 (63.5)	1.13 (28.7)	0.60 (15.2)	1.50 (38.1)	0.60 (15.2)	1.093 (27.8)	0.8	0.40

30 dB Ultra-Broadband Monitor Coupler

30 dB Ultra-Broadband Monitor Coupler

- 2.0 - 18.0 GHz Frequency Band
- 100 Watt Input Power
- N, TNC, or SMA Connectors
- Small Size, Light Weight

This Ultra-Broadband 30 dB Coupler was designed to provide a simple way to monitor signals over a very wide bandwidth. It is very useful for detecting the presence of a microwave signal that is present or supposed to be present on the primary line. The primary line can sustain 100 Watt average power levels and 3.2 kW peak.



Specifications	
Frequency, (GHz)	2.0 - 18.0
Coupling Value, (dB):	30
Coupling Accuracy, (± dB, max):	
2.0-4.0 GHz	5.0
4.0-18.0 GH	2.0
Insertion Loss, (dB, max.)	0.6
Directivity, (dB, min.):	10
VSWR, (max.):	1.5
Average Input Power, (W, max):	100
Peak power, (kW, max.)	3.2
Operating Temperature, (°C)	0 to +55
Finish Connectors:	Passivated Stainless Steel

Note: SMA or Type TNC output connectors are available by substituting "SMA" or "TNC" for "NNN" in the Model Number.

Part No.

CPL-5028-30-NNN-79

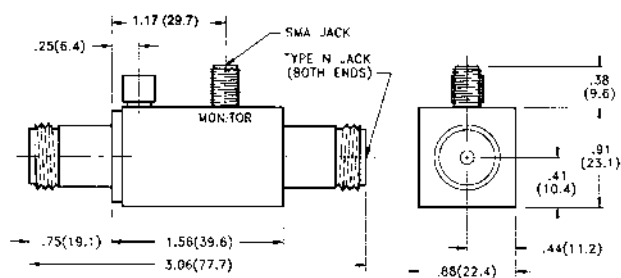

Power Dividers

General Information.....	74
Definition of Parameters	75
Resistive Types	76
Two Way Isolated	77
Three Way Isolated.....	78
Four Way Isolated.....	79
Eight Way • Twelve Way	80

3 Attenuators**31 Terminations****58 DC Blocks****61 Couplers****73 Power Dividers****81 Equalizers****85 Phase Shifters****87 Between Series Adapters****116 In-Series Adapters****127 Connectors****177 QPL Approved Products &
Tools for Assembly****200 Appendix****209 Index**

General Information

- DC - 18.0 GHz High Performance
- Broadband and Ultra-Broadband Frequency Coverage
- High Isolation – Low Phase and Amplitude Unbalance
- Small Size, Light Weight, Rugged Construction

Power Dividers are passive devices that divide an input signal into any number of equal output signals. The ability of a power divider to provide identical phase matched output signals from one input signal, measures its design integrity and quality. Attaining these equal output signals is also dependent on the impedance match of the device or microwave system it is being used in conjunction with as well as the level of isolation between output ports.

Midwest Microwave manufactures Wilkinson type isolated power dividers covering octave and multi-octave frequency bandwidths as well as ultra-wide frequency bandwidth types. The Wilkinson design types are particularly useful in systems where the divided signals are required to remain in phase with each other and their amplitudes relatively equal. Resistive power dividers are also available that offer very broadband performance. This type is small and very broadband and maintains an equal and consistent VSWR and insertion loss.

Standard catalog units are available with SMA connectors with other connector types available upon special request. Some items are available off the shelf for immediate delivery or special units can be custom designed by Midwest Microwave's experienced engineering staff to accommodate unique system needs. All Midwest Power Dividers are completely manufactured in house and are 100% tested to insure only the highest quality performance whether for military or space use or for commercial cellular or personal communications applications.



Typical Power Divider Characteristics

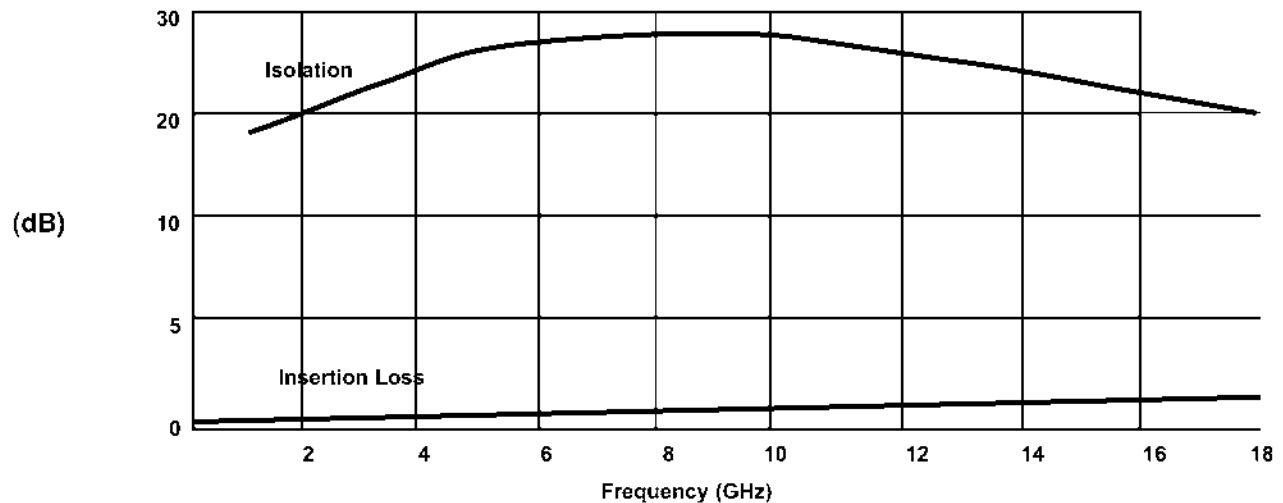

Division/Combining

In-Phase power division is accomplished through a network with one signal input and “n” outputs whose phase difference is 0° and resulting signal amplitudes are equal at each output. When combining signals, the relationship between each input signal must also be equal in phase and amplitude so that the combination can be accomplished with the lowest amount of power loss.

VSWR

The VSWR performance of a power divider is defined as the maximum value measured over the entire specified frequency band when a signal input at the common input port and all output ports are terminated in 50 Ohms.

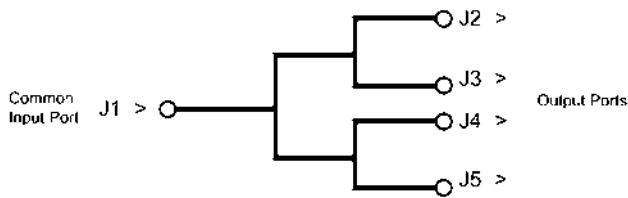

Figure 1

Frequency

Power Dividers, if designed properly, will perform satisfactorily over wide frequency bands. The lower the operating frequency the longer the wavelength and hence the longer the physical length of the power divider must be. Design goals are continually aimed toward broadening the frequency bandwidth as much as possible while simultaneously maintaining as short and small a unit as possible to satisfy system size and weight requirements.

Insertion Loss

In Power Dividers, insertion loss is defined as the loss measured through the power divider excluding the power division factor. More specifically, it is the ratio of the power output to the power input, with the assumption that the source of power is matched as well as the terminated ports when the measurement was taken. Since transmission line loss increases with frequency, the values shown are minimal at the lowest frequency and increase linearly as the length of the power divider increases.

Loss due to dissipation in the circuit will increase the insertion loss by the amount of power dissipation in dB.



Isolation

Isolation in Power Dividers is defined as the isolation between any two output ports. Expressed in dB, it is the ratio of the output power of one output port to the input power of any other output port, when measured with matched terminations on all other ports. High isolation between ports is a very desirable feature in most power divider applications especially between adjacent ports because it is there that signal interaction is most likely to take place.

Amplitude Balance

The amplitude balance, expressed in dB, is the difference between the amplitude of the signal at each of the output ports. It is the ratio of the level of maximum signal at any output port to the level of the minimum signal at any other output port. Usually this unbalance is quite low in isolated (Wilkinson) two way power dividers and increases as the number of output ports increases.

Phase Balance

The phase unbalance is the difference between the phase of the signals that arrive at each output port. It is expressed in degrees. It is the maximum deviation that is measured between any one output port and any other output port. The average phase unbalance is substantially lower particularly at the lower frequencies.

Power, Average

The maximum power that may be applied to the common or input port with all other output ports terminated in 50 Ohm loads that have inherent VSWR's that do not exceed 2.0:1.

Resistive Types

Two Way Broadband Power Division

- DC - 12.4 and DC - 18.0 GHz Bandwidth Units
- Symmetrical Loss and Phase Balance
- Rugged Construction

Midwest Microwave's series of Resistive Two Way Power Dividers are very broadband devices that are small, lightweight, ruggedly constructed units that possess consistent VSWR and insertion loss. They also exhibit excellent phase and amplitude tracking. Units are available in wideband frequency bandwidths covering the range of DC - 12.4 GHz and DC - 18.0 GHz.



Specifications		
Model	PWD-2532	PWD-2533
Frequency, (GHz)	DC - 12.4	DC - 18.0
Nominal Impedance, (Ω)	50	
Nominal Insertion Loss, (dB):	6	
Insertion Loss Tolerance, (+/- dB, max):	DC-10.0 GHz	1.2/ 0.2
	10.0-18.0 GHz	1.5/ 0.2
Assymetry, (dB, max.)	DC-4.0 GHz	0.4
	10.0-18.0 GHz	0.5
VSWR, (max.):	DC-10.0 GHz	1.25
	10.0-18.0 GHz	1.35
Average Input Power, (W, max):	1	
Operating Temperature, ($^{\circ}$ C)	-55 to +125	
Finish Connectors:	Passivated Stainless Steel	

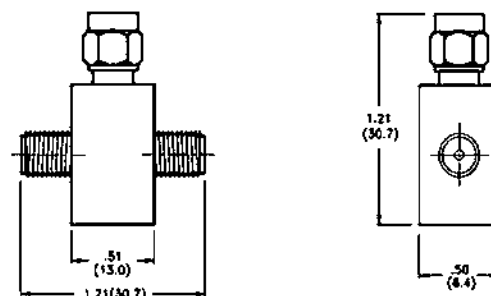

DC - 12.4 GHz	DC - 18.0 GHz
PWD-2532-02-SMA-79	PWD-2533-02-SMA-79

R.F. Signal Monitor

- Bite System Application
- Small Size, Light Weight
- Rugged Construction

Midwest Microwave offers a wide variety of Signal Monitor components. The unit described here is a passive device that monitors the signal that is flowing in a transmission line. It is a linear device that extracts a very small portion of the energy in the primary line in order to monitor the presence of a signal on that line.



Specifications	
Frequency, (GHz)	DC - 2.5
Nominal Impedance, (Ω)	50
Coupling Value, (dB):	26
Coupling Accuracy, (\pm dB, max):	1.2
Insertion Loss, (dB, max.)	0.5 \pm 0.15
VSWR, (max.):	1.2
Average Input Power, (W, max):	1
Operating Temperature, ($^{\circ}$ C)	-55 to +125
Finish Connectors:	Passivated Stainless Steel

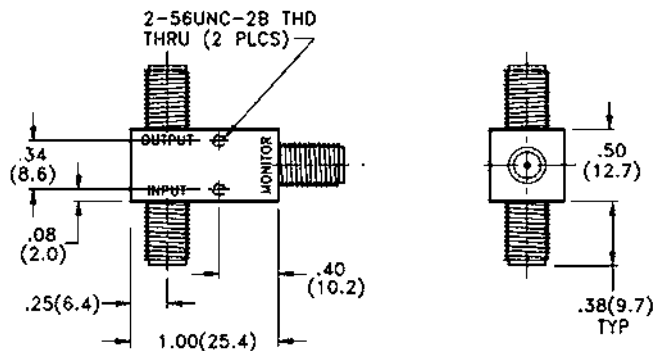

Part No.
RFM-7020-26-SMA-79

Note: TNC, BNC, or Type N connectors are available by substituting "TNC", "BNC", or "NNN" for "SMA" in the Model Number.

500.0 MHz – 18.0 GHz High Performance

- Full Octave, Multi-Octave, and Ultra-Wideband Performance
- Excellent Phase and Amplitude Tracking
- Small Lightweight Rugged Stripline Construction
- 50 Ohm Nominal Impedance

Midwest Microwave's series of high performance isolated Power Dividers are small, lightweight, ruggedly constructed stripline units that possess inherently low insertion loss and VSWR with high isolation and excellent phase and amplitude tracking. Units are available in octave, multi-octave, and ultra-wideband frequency bandwidths covering the entire range of 0.5 - 18.0 GHz.

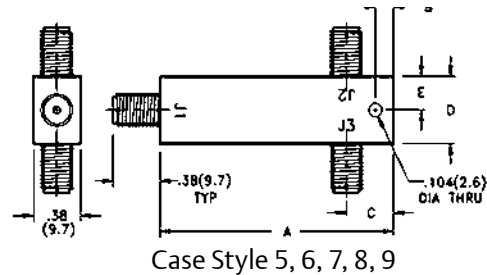
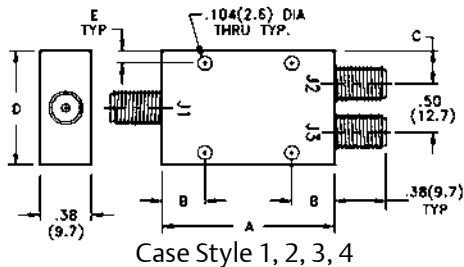

Electrical Specifications

Frequency Range GHz	Case Style		Part Number	Amplitude Balance dB (max.)	Phase Balance °(max.)	Insertion Loss dB (max.)	Isolation dB (min.)	VSWR (max.)	Average Power W (max.)
	In-Line	Tee*							
Octave Bandwidth Types									
1.0-2.0	2	6	PWD-5511-02-SMA-79	0.20	2	0.4	20	1.25	30
2.0-4.0	2	7	PWD-5512-02-SMA-79	0.20	2	0.4	20	1.35	3
4.0-8.0	1	5	PWD-5514-02-SMA-79	0.20	3	0.5	20	1.35	30
8.0-12.4	1	5	PWD-5515-02-SMA-79	0.30	5	0.5	20	1.50	30
12.4-18.0	1	5	PWD-5517-02-SMA-79	0.30	5	0.5	20	1.50	30
Multi-Octave Bandwidth Types									
0.5-2.0	2	8	PWD-5520-02-SMA-79	0.20	4	0.5	20	1.25	20
2.0-8.0	2	7	PWD-5522-02-SMA-79	0.30	4	0.5	20	1.35	30
6.0-18.0	1	5	PWD-5526-02-SMA-79	0.30	5	0.6	18	1.50	3
2.0-18.0	3	N/A	PWD-5532-02-SMA-79	0.25	8	1.0	17	1.60	10
2.0-18.0	2	7	PWD-5533-02-SMA-79	0.30	5	0.8	15	1.50	10
0.5-18.0	4	9	PWD-5530-02-SMA-79	0.30	5	2.1	18	1.50	10

* For TEE models substitute '02' in model part number with "T2".

Mechanical Specifications – Nominal

Case Style	A		B		C		D		E		Weight	
	in	mm	in	mm	in	mm	in	mm	in	mm	oz	g
1	1.00	25.4	0.50	12.7	0.25	6.35	1.00	25.4	0.08	1.9	1.0	27
2	2.00	50.8	0.50	12.7	0.25	6.35	1.00	25.4	0.08	1.9	2.2	60
3	2.25	57.1	0.50	12.7	0.25	6.35	1.00	25.4	0.08	1.9	2.5	67
4	5.50	139.7	0.75	19.1	0.25	6.35	1.00	25.4	0.20	5.1	3.7	100
5	1.00	25.4	0.50	12.7	0.22	5.58	0.50	12.7	0.08	1.9	0.9	23
6	2.00	50.8	0.50	12.7	0.22	5.58	0.70	17.8	0.08	1.9	2.2	60
7	2.00	50.8	0.50	12.7	0.22	5.58	0.50	12.7	0.08	1.9	1.7	47
8	2.00	50.8	0.50	12.7	0.22	5.58	1.00	25.4	0.08	1.9	2.2	60
9	5.50	139.7	0.75	19.1	0.40	10.16	0.80	12.7	0.08	1.9	3.7	100

Note: 1. Specifications assume that all of the outputs are terminated with a load that has a VSWR not greater than 2.0:1.
2. TNC or Type N connectors are available by substituting "TNC" or "NNN" for "SMA" in the Model Number.

Three Way Isolated

True Three Way Isolated Power Division

- Full 2.0 - 18.0 GHz Bandwidth Units
- Low VSWR – High Isolation
- Rugged Stripline Construction
- 50 Ohm Nominal Impedance

Midwest Microwave's series of high performance isolated Three Way Power Dividers are true three way dividers. They are small, lightweight, ruggedly constructed stripline units that possess inherently low insertion loss and VSWR with high isolation and excellent phase and amplitude tracking. Units are available in ultra-wideband frequency bandwidths covering the entire range of 2.0 - 18.0 GHz.

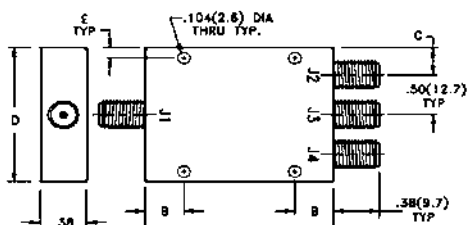

Case Style 1

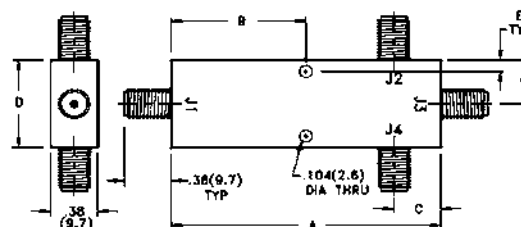

Case Style 2

Electrical Specifications

Frequency Range GHz	Case Style	Part Number	Amplitude Balance dB (max.)	Phase Balance ° (max.)	Insertion Loss dB (max.)	Isolation dB (min.)	VSWR (max.)	Average Power W (max.)
0.5-2.0	1	PWD-5520-03-SMA-79	0.5	5	1.0	15	1.5	5
2.0-18.0	2	PWD-5532-03-SMA-79	0.5	5	1.0	20	1.5	10
2.0-18.0	1	PWD-5533-03-SMA-79	0.5	10	1.2	15	1.8	30

Nominal Mechanical Specifications – inches (mm)

Case Style	A	B	C	D	E	Weight oz	g
1	3.00 (76.2)	0.63 (16.0)	0.250 (6.35)	1.50 (38.1)	0.080 (2.0)	3.15	89
2	2.50 (63.5)	1.25 (31.8)	0.375 (9.5)	0.75 (19.0)	0.080 (2.0)	1.80	51

Note: 1. Specifications assume that all of the outputs are terminated with a load that has a VSWR not greater than 2.0:1.
 2. TNC or NType connectors are available by substituting "TNC" or "NNN" for "SMA" in the Model Number.

500.0 MHz – 18.0 GHz High Performance

- Full 2.0 - 18.0 GHz Bandwidth Units
- Low VSWR – High Isolation
- Rugged Stripline Construction
- 50 Ohm Nominal Impedance

Midwest Microwave's series of high performance isolated Power Dividers are small, lightweight, ruggedly constructed stripline units that possess inherently low insertion loss and VSWR with high isolation and excellent phase and amplitude tracking. Units are available in multi-octave, and ultra-wideband frequency bandwidths covering the entire range of 0.5 - 18.0 GHz.

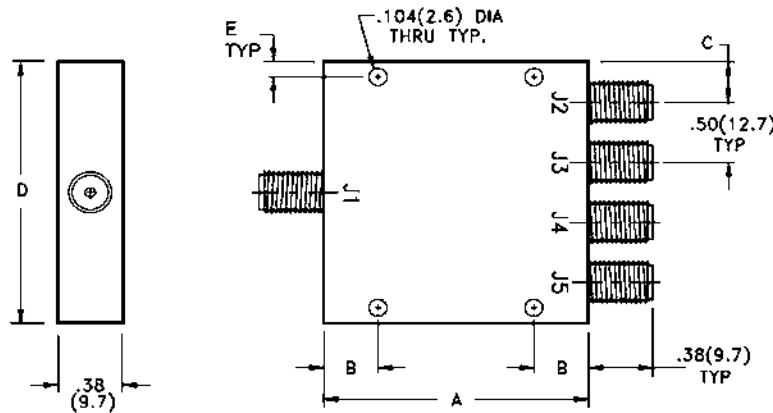

Electrical Specifications

Frequency Range GHz	Case Style	Part Number	Amplitude Balance dB (max.)	Phase Balance ° (max.)	Insertion Loss dB (max.)	Isolation dB (min.)	VSWR (max.)	Average Power W (max.)
0.5-2.0	1	PWD-5520-04-SMA-79	0.5	10	1.0	18	1.50	5
2.0-8.0	1	PWD-5522-04-SMA-79	0.5	10	1.0	18	1.50	5
6.0-18.0	2	PWD-5526-04-SMA-79	0.5	10	1.0	18	1.50	5
2.0-18.0	1	PWD-5532-04-SMA-79	0.5	10	1.5	18	1.50	5
0.5-18.0	3	PWD-5530-04-SMA-79	0.5	10	4.1	16	1.50	5

Nominal Mechanical Specifications – inches (mm)

Case Style	A	B	C	D	E	Weight oz	g
1	3.00 (76.2)	0.63 (16.0)	0.250 (6.35)	2.00 (50.8)	0.080 (2.00)	5.2	140
2	1.46 (37.1)	0.73 (18.5)	0.250 (6.35)	2.00 (50.8)	0.080 (2.00)	2.05	58
3	5.20 (132.1)	1.00 (25.4)	0.250 (6.35)	2.00 (50.8)	0.080 (2.00)	7.30	207

Note: 1. Specifications assume that all of the outputs are terminated with a load that has a VSWR not greater than 2.0:1.
2. TNC or NType connectors are available by substituting "TNC" or "NNN" for "SMA" in the Model Number.

Eight Way • Twelve Way

0.5 – 18.0 GHz High Performance

- Full 2.0 - 18.0 GHz Bandwidth Units
- Low VSWR – High Isolation
- Rugged Stripline Construction
- 50 Ohm Nominal Impedance

Midwest Microwave's series of high performance isolated Power Dividers are small, lightweight, ruggedly constructed stripline units that possess inherently low insertion loss and VSWR with high isolation and excellent phase and amplitude tracking. Units are available in multi-octave, and ultra-wideband frequency bandwidths covering the entire range of 0.5 - 18.0 GHz.

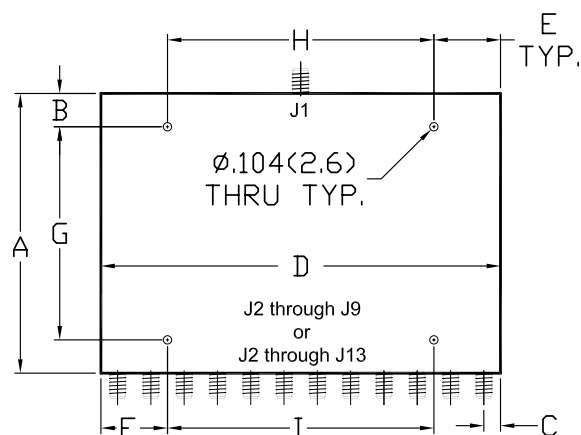

Electrical Specifications

Frequency Range GHz	Case Style	Part Number	Amplitude Balance dB (max.)	Phase Balance ° (max.)	Insertion Loss dB (max.)	Isolation dB (min.)	VSWR (max.)	Average Power W (max.)
Eight Way Multi-Octave Bandwidth Types								
0.5-2.0	1	PWD-5520-08-SMA-79	0.5	5	1.2	15	1.50	10
2.0-8.0	2	PWD-5522-08-SMA-79	0.8	10	1.2	15	1.50	30
5.0-19.0	3	PWD-5526-08-SMA-79	0.6	8	1.9	18	1.50	10
2-0-18.0	2	PWD-5532-08-SMA-79	0.6	10	2.5	15	1.50	50
0.5-18.0	4	PWD-5530-08-SMA-79	1.0	15	5.5	15	1.50	30
Twelve Way Multi- Octave Bandwidth Types								
0.5-2.0	8	PWD-5520-12-SMA-79	0.6	10	1.2	15	1.50	10
2.0-8.0	6	PWD-5522-12-SMA-79	1.0	15	1.4	15	1.50	30
6.0-18.0	5	PWD-5526-12-SMA-79	0.8	10	2.2	15	1.50	10
2.0-18.0	6	PWD-5532-12-SMA-79	1.0	15	3.5	15	1.50	30
0.5-18.0	7	PWD-5530-12-SMA-79	1.2	20	6.6	15	1.60	50

Nominal Mechanical Specifications

Case Style	A		B		C		D		E		F		G		H		I		Weight	
	in	mm	in	mm	in	mm	in	mm	in	mm	in	mm	in	mm	in	mm	in	mm	oz	g
1	3	76.2	0.15	3.8	0.25	6.4	4	101.6	0.5	12.7	1	25.4	2.6	66	3	76.2	2	50.8	8.4	2.39
2	4.6	116.8	0.55	14	0.25	6.4	4	101.6	0.25	6.35	0.25	6.35	3.5	88.9	3.5	88.9	3.5	88.9	12.3	349
3	3.5	88.9	0.5	12.7	0.25	6.4	4	101.6	0.2	5.08	0.2	5.08	2.5	63.5	3.6	91.4	3.6	91.4	9	273
4	5.2	132.1	1	25.4	0.25	6.4	4	101.6	0.2	5.08	0.2	5.08	3.2	81.3	3.6	91.4	3.6	91.4	13.9	390
5	4.6	116.8	0.25	6.4	0.25	6.4	6	152.4	0.25	6.35	0.25	6.35	3.5	88.9	2.6	66	2.6	66	18.8	540
6	5.2	132.1	1.13	28.7	0.25	6.4	6	152.4	0.25	6.35	0.25	6.35	2.94	74.7	5.5	139.7	5.5	139.7	21.2	600
7	7.5	190.5	1.5	38.1	0.25	6.4	6	152.4	0.25	6.35	0.25	6.35	4.5	114.3	5.5	139.7	5.5	139.7	24.5	700
8	5.2	132.1	0.5	12.7	0.25	6.4	6	152.4	1	25.4	1	25.4	4.2	106.7	4	101.6	4	101.6	24	680

Note: 1. Specifications assume that all of the outputs are terminated with a load that has a VSWR not greater than 2.0:1.

2. TNC or NType connectors are available by substituting "TNC" or "NNN" for "SMA" in the Model Number.

Equalizers

General Information	82
Definition of Parameters	83
Fixed Loss Linear Slope Types	84

3	Attenuators
----------	--------------------

31	Terminations
-----------	---------------------

58	DC Blocks
-----------	------------------

61	Couplers
-----------	-----------------

73	Power Dividers
-----------	-----------------------

81	Equalizers
-----------	-------------------

85	Phase Shifters
-----------	-----------------------

87	Between Series Adapters
-----------	--------------------------------

116	In-Series Adapters
------------	---------------------------

127	Connectors
------------	-------------------

177	QPL Approved Products & Tools for Assembly
------------	---

200	Appendix
------------	-----------------

209	Index
------------	--------------

While every precaution has been taken to ensure accuracy and completeness herein, Emerson Network Power Connectivity Solutions assumes no responsibility, and disclaims all liability for damages resulting from use of this information or for any errors or omissions. Specifications subject to change without notice.

General Information

- DC - 18.0 GHz High Performance
- Broadband or Narrowband Frequency Coverage
- Linear Slope – Positive or Negative
- Half Sine or Half Sine Inverted*
- Linear Slope/Fine Grain and Half Sine/Fine Grain*

*Available as Custom Models



Equalizers are passive microwave devices that have an insertion loss characteristic that varies as a function of frequency. Midwest Microwave's Equalizers can be supplied with a precisely defined and preset loss characteristic, commonly known as a Fixed Loss Equalizer, or with the additional ability to be loss adjusted to custom fit the particular variable requirements needed to fine tune a system. When this added tuning ability is included, the units are known as Adjustable Equalizers. When a Harmonic Phase Shifter is added, usually built-in to the assembly, the device is known as an Optimizer. Further enhancement can be attained by adding Isolators to the assembly to form an Iso-Optimizer. Midwest Microwave manufactures all of the fore mentioned devices on custom bases covering a wide range of frequency bands and in a wide variety of configurations and interfaces.

Application of equalizers usually falls into the following categories:

1. To introduce an insertion loss characteristic that is identical but opposite to the gain characteristic of a traveling wave tube amplifier (TWT) such that the two devices together will exhibit a flat gain characteristic over a specified frequency band.
2. To introduce an insertion loss characteristic that is opposite to the insertion loss characteristic of a fixed length of coaxial cable or waveguide transmission line such that the two components together exhibit a flat loss characteristic over a specified frequency band.
3. To introduce an insertion loss characteristic in a series of microwave components that includes both gain and loss such that the resultant loss characteristic is flat over the frequency band.

Typical Gain Equalizer Characteristics

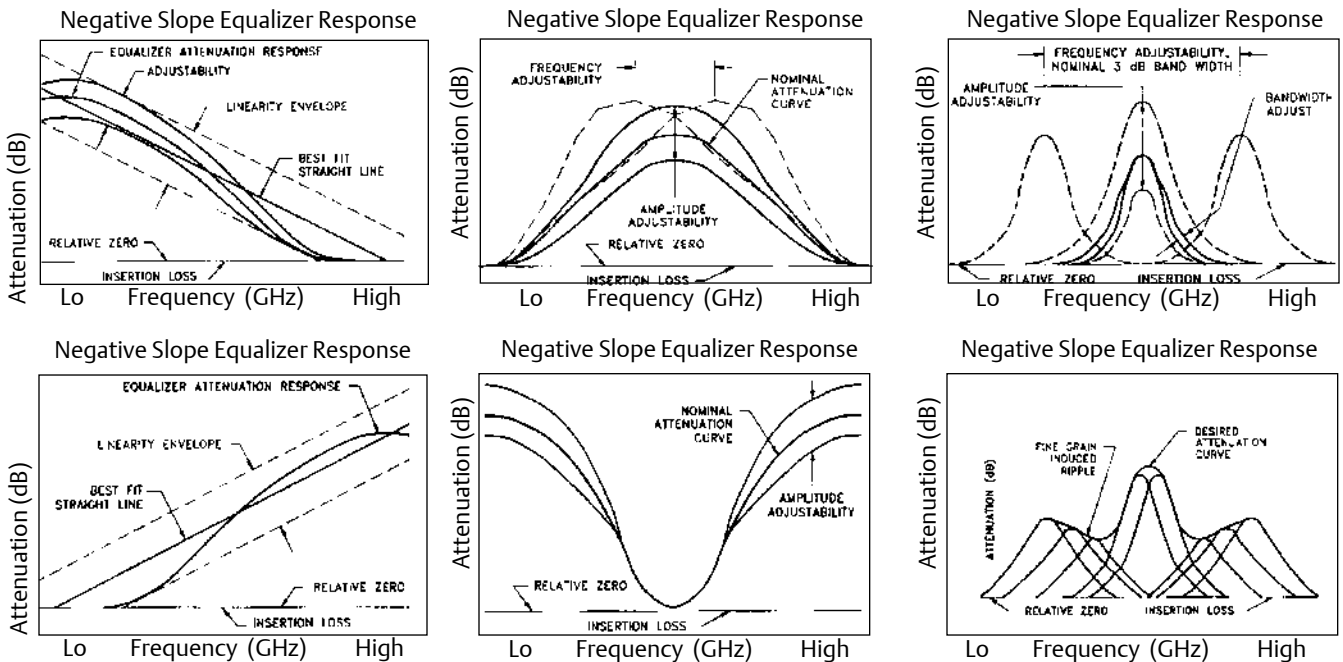

Frequency Range

The operating frequency band specified by the user over which the microwave system or devices must exhibit the desired attenuation vs. frequency response and must otherwise perform to the required specifications. Frequency bandwidths can vary from less than 1% to multi-octave and can occur anywhere over the range of 500.0 MHz to 26.5 GHz.

Attenuation

The compensation, adjustment, and shaping of the attenuation vs. frequency response of a singular device or of a complete system of microwave devices such that the resultant power output curve is either flat with frequency or is shaped in the desired way that permits the system to operate efficiently. This is the primary goal of a Gain Equalizer.

Insertion Loss

In Gain Equalizers, the insertion loss is the sum of both absorptive and reflective losses, measured at the frequency where minimum attenuation occurs for linear slope Equalizers; at the highest and the lowest operating frequencies for parabolic half sine type Equalizers; and at the band edges for the parabolic inverted half sine type Equalizers. It is clear that the specified attenuation level is always relative to the insertion loss of a Gain Equalizer. A typical method used in selecting an insertion loss specification is to take 10% of the maximum attenuation point and add .25 dB to that value.

VSWR

The input VSWR performance of an Equalizer is defined as the maximum value measured over the entire specified frequency band when a signal is input at the input port and the output ports is terminated in 50 Ohms. VSWR is dependent on such factors as attenuation level, operating frequency range, size, configuration and adjustability requirements. Input and output VSWR usually will not exceed 2.0:1.

Linearity

is defined as the deviation from the best fit straight line through the measured attenuation curve. Usually this deviation is less than $\pm 7\%$ of the maximum attenuation level. The allowable loss deviation from the nominal curve can be specified in dB or percent of loss.

Adjustability

Equalizers can be amplitude and frequency adjustable to allow the user to compensate for changes in amplifier gain response. The adjustment range to be built into the

Equalizer will determine the number of loss sections both fixed and adjustable required to provide the specified adjustment range. Typically the adjustment range is $\pm 15\%$ of the maximum attenuation. In the case of parabolic Equalizers, this adjustment can be made over a bandwidth that is approximately $\pm 5\%$ of the frequency at which the maximum attenuation occurs.

Tuner

User adjustable loss element that is used to adjust loss characteristics and loss curve with frequency.

Tuner Bandwidth

The frequency span measured at the 3 dB loss points of the loss introduced by the tuner.

Fixed Loss Equalizer

Equalizers that are adjusted and pre-set at the factory, sealed, and used as fixed loss devices over their frequency of operation.

Negative Linear Slope

Insertion Loss decreases linearly with frequency, maximum loss occurs at the lowest frequency.

Positive Linear Slope

Insertion Loss increases linearly with frequency, maximum loss occurs at the highest frequency.

Parabolic Half Sine

Attenuation increases from the low frequency band edge reaching its peak at mid-frequency, then decreases from high to low at the upper frequency band edge. This type of Equalizer is used primarily for compensating gain variations in traveling wave tube or solid state amplifiers where the maximum gain is at or near the middle of the frequency band.

Parabolic Inverted Half Sine

Attenuation decreases monotonically with frequency from both band edges to its lowest point at mid-frequency band. This type of Equalizer compensates for accumulative gain variations of a system when the gain is highest at the upper most and lowest operating frequencies.

Connectors

SMA female connectors are standard however other SMA, TNC, N, and other connectors are also available upon request.

Fixed Loss Linear Slope Types

Linear Slope Positive or Negative

- 2.0 - 18.0 GHz Performance
- -55 to +125°C Operation
- Rugged Construction
- 50 Ohm Nominal Impedance
- Custom Models



Midwest Microwave's series of linear slope fixed loss Equalizers are very broadband devices that are small, lightweight, ruggedly constructed units that possess consistently low VSWR and linear insertion loss. They also exhibit excellent phase and amplitude tracking. Units are available in wide frequency bandwidths covering the range of 2.0 - 18.0 GHz.

Specifications

Frequency Range GHz	Part Number	Part Number	Attenuation* dB (max.)	Insertion Loss dB (max.)	Linearity \pm dB (max.)	VSWR (max.)	Passivated Stainless Steel Interface	Weight g (nom.)
2.0-8.0	EQL-4424-08-POS-79	EQL-4424-08-NEG-79	8	1.0	0.50	1.70	SMA	100
8.0-18.0	EQL-4426-12-POS-79	EQL-4426-12-NEG-79	12	1.0	0.75	1.80	SMA	100
2.0-18.0	EQL-4432-10-POS-79	EQL-4432-10-NEG-79	10	1.2	0.75	1.70	SMA	100
2.0-18.0	EQL-4431-18-POS-79	EQL-4431-18-NEG-79	18	1.5	1.00	1.80	SMA	100
2.0-18.0	EQL-4431-24-POS-79	EQL-4431-24-NEG-79	24	2.0	1.00	1.70	SMA	100

* Not including insertion loss

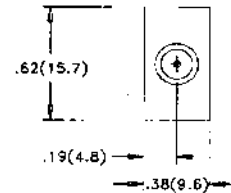
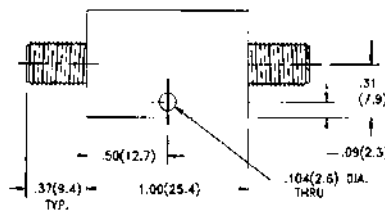

Positive Slope Equalizer Response

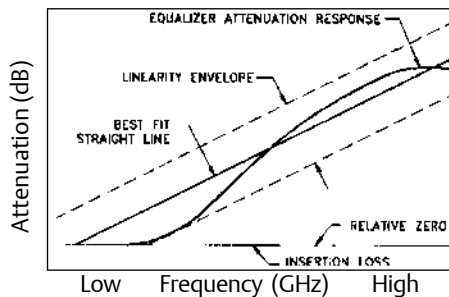

Negative Slope Equalizer Response

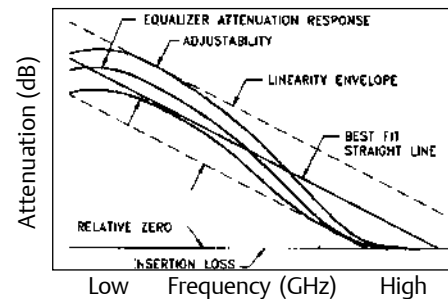

Phase Shifters

Line Stretcher Type 86

3 Attenuators

31 Terminations

58 DC Blocks

61 Couplers

73 Power Dividers

81 Equalizers

85 Phase Shifters

87 Between Series Adapters

116 In-Series Adapters

127 Connectors

177 QPL Approved Products &
Tools for Assembly

200 Appendix

209 Index

Line Stretcher Type

30°, 60°, & 90° per GHz Phase Shifter

- DC - 18.0 GHz Frequency Range
- Low Insertion Loss
- 50 Watts Average Power
- Rugged Construction
- 50 Ohm Nominal Impedance

This series of broad band Line Stretcher type Phase Shifters were designed to provide phase slope adjustment in a fixed system of microwave components. They utilize precision internal airline design techniques in small, lightweight, ruggedly constructed units that consistently perform phase slope adjustment functions through the use of a smooth, continuous, trombone type mechanism that allows precise field adjustment and firm locking arrangement.



Specifications											
Frequency Range GHz	Part Number	Phase Shift °/GHz	VSWR (max.)	Insertion Loss Formula	Insertion Loss* dB (max.)	Average Power W (max.)	Peak Power kW (max.)	Nominal Dimensions inches/mm			Weight (nom.) oz / g
								A	C	H	
DC - 18.0	PHS-6021-FF-SMA-79	30	DC - 10 GHz: 1.30	0.3+.025f	0.75	50	1	2.50	0.50	1.25	2.5
			10-18 GHz: 1.50					63.5	12.7	31.75	72
DC - 18.0	PHS-6022-FF-SMA-79	60	DC - 10 GHz: 1.40	0.3+.035f	0.93	50	1	3.50	1.00	1.75	3.5
			10-18 GHz: 1.60					88.9	25.4	44.45	100
DC - 18.0	PHS-6023-FF-SMA-79	90	DC - 10 GHz: 1.50	0.3+.045f	1.11	50	1	4.50	1.50	2.25	4.5
			10-18 GHz: 1.70					114.3	38.1	57.15	28.6

Note: Please call for different SMA connector gender configuration.

* At 18.0 GHz

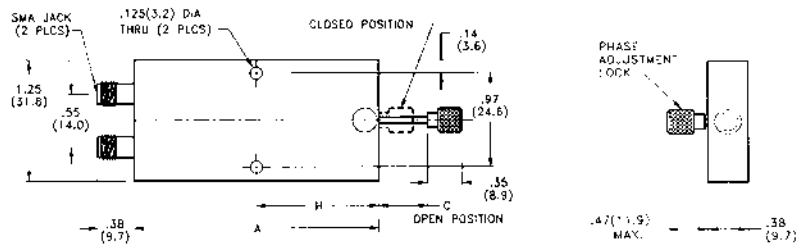

Typical Performance

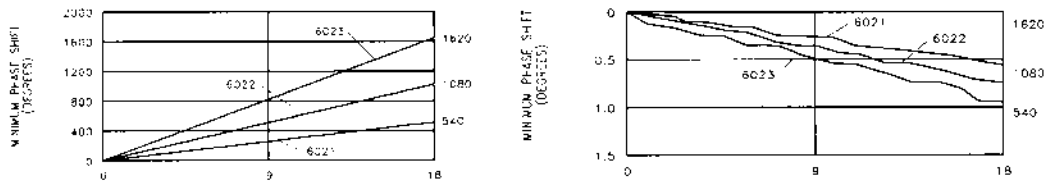

Between Series Adapters

Adapter Selection Guide	88
7mm to SMA	89
7mm to SMA / 7mm to 3.5mm	90
7mm to SSMA	91
7mm Rebuild Kits	92
7mm to Type N.....	93
7mm to TNC / 7mm to SC.....	94
7mm to HC / 7mm to BMA	95
N to 3.5mm.....	96
N to SMA	97
N Flange Mount to SMA.....	98
N Bulkhead to SMA.....	99
N to SSMA	100
N Flange Mount to SSMA.....	101
N to SMA / Economical	102
N to SSMA / Economical	103
N to TNC	104
N to BNC	105
N to SC.....	106
N to HN	107
TNC to SMA.....	108
TNC Bulkhead to SMA / TNC Flange Mount to SMA..	109
BNC to SMA.....	110
SMA to SSMA.....	111
SMA to SMM.....	112
SMA to BMA	113

3 Attenuators

31 Terminations

58 DC Blocks

61 Couplers

73 Power Dividers

81 Equalizers

85 Phase Shifters

87 Between Series Adapters

116 In-Series Adapters

127 Connectors

177 QPL Approved Products & Tools for Assembly

200 Appendix

209 Index

Adapter Selection Guide

DC – 40.0 GHz Performance

- Low VSWR and Insertion Loss
- 100% Swept Frequency Tested
- MIL-C-39012 Interfaces
- Rugged Stainless Steel Construction

Midwest Microwave offers this complete line of high performance precision Coaxial Adapters. They are available in almost all of the popular connector interfaces including 2.92mm, 3.5mm, and 7mm. They incorporate design features that provide consistent low VSWR and insertion loss performance in a minimum length compact physical package that operates over a broad frequency range. Special designed adapters are also available in a wide variety of configurations and interfaces upon request.



Specifications	
Frequency:	DC – 40.0 GHz typical
Impedance:	50 Ohms
VSWR:	as noted
Insertion Loss:	0.5 dB max. typical
Operating Temperature:	-65 to +125°C

Construction	
Outer Conductor Housings:	Passivated Stainless Steel or Nickel Plated Brass as noted
Inner Conductors:	Gold Plated Beryllium Copper
Dielectric Insulators:	Polytetrafluorethylene (PTFE)

Selection Guide

Choose Adapter combination desired from the vertical and horizontal columns and find page no. at their intersection.

	SMA	SSMA	SMM	BMA	2.9mm	3.5mm	7mm	N	TNC	BNC	SC	HN
SMA	117-118	111	112	113-115	*	*	126-127	134-135 & 139	145-146	147 & 160	*	*
SSMA	148						128	137-138 & 140	*	*		
SMM	149						*	*				
BMA	150-152						132					
2.9mm	*				120			*				
3.5mm	*					119	127	133				
7mm	89-90	91		95	*	90	162	93	94		94	95
N	97-99, 102	100-101, 103			*	96	130	121	104	105	106	107
TNC	108-109	*					131	141	122	*	*	*
BNC	110	*					*	142	*	123	*	*
SC	*						131	143	*	*	124	
HN	*						132	144	*	*		125

Note: SMA to SMC Adapters are available on special request.

* Available on request. Contact customer service for availability for those indicated as well as for those desired Adapters that are not indicated.

7mm to SMA Male Plug

Part No.

ADT-2540-7M-SMM-02

Specifications

Frequency:	DC – 18.0 GHz
Impedance:	50 Ohms
VSWR:	1.025 + .0025 f (GHz)
Finish:	Passivated Stainless Steel

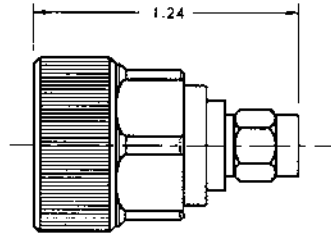

7mm to SMA Female Plug

Part No.

ADT-2541-7M-SMF-02

Specifications

Frequency:	DC – 18.0 GHz
Impedance:	50 Ohms
VSWR:	1.025 + .0025 f (GHz)
Finish:	Passivated Stainless Steel

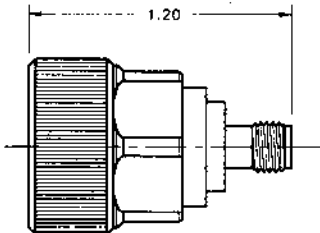

7mm to SMA Male Plug – Long Neck Adapter

Part No.

ADT-2675-7M-SMM-02

Specifications

Frequency:	DC – 18.0 GHz
Impedance:	50 Ohms
VSWR:	1.025 + .0025 f (GHz)
Finish:	Passivated Stainless Steel

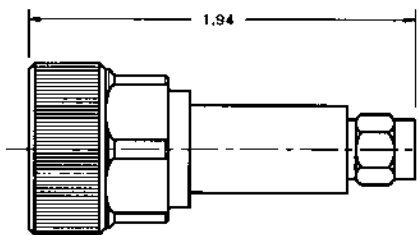

7mm to SMA Female Plug – Long Neck Adapter

Part No.

ADT-2676-7M-SMF-02

Specifications

Frequency:	DC – 18.0 GHz
Impedance:	50 Ohms
VSWR:	1.025 + .0025 f (GHz)
Finish:	Passivated Stainless Steel

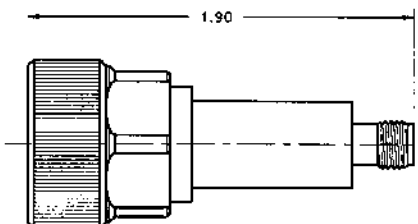

7mm to SMA / 7mm to 3.5mm

7mm Flange Mount to SMA Male Plug

Part No.

ADT-2655-7M-SMM-02

Specifications

Frequency:	DC – 18.0 GHz
Impedance:	50 Ohms
VSWR:	1.025 + .0025 f (GHz)
Finish:	Passivated Stainless Steel

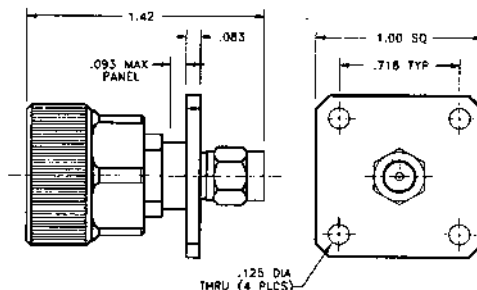

7mm Flange Mount to SMA Female Jack

Part No.

ADT-2653-7M-SMF-02

Specifications

Frequency:	DC – 18.0 GHz
Impedance:	50 Ohms
VSWR:	1.025 + .0025 f (GHz)
Finish:	Passivated Stainless Steel

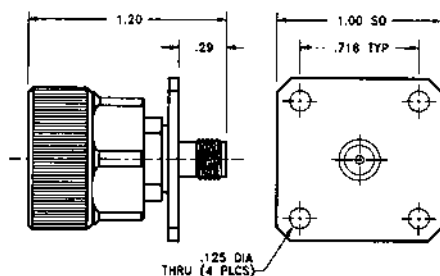

7mm to 3.5mm Male Plug

Part No.

ADT-2701-7M-3MM-02

Specifications

Frequency:	DC – 18.0 GHz
Impedance:	50 Ohms
VSWR:	1.025 + .0025 f (GHz)
Finish:	Passivated Stainless Steel

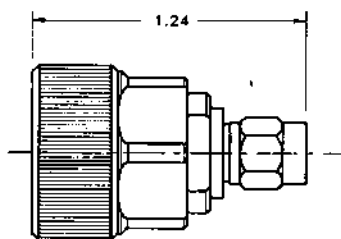

7mm to 3.5 mm Female Jack

Part No.

ADT-2702-7M-3MF-02

Specifications

Frequency:	DC – 18.0 GHz
Impedance:	50 Ohms
VSWR:	1.025 + .0025 f (GHz)
Finish:	Passivated Stainless Steel

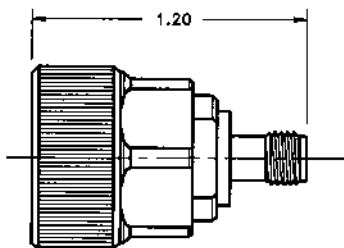

7mm to SSMA Male Plug

Part No.

ADT-2703-7M-SSM-02

Specifications

Frequency:	DC – 18.0 GHz
Impedance:	50 Ohms
VSWR:	1.09
Finish:	Passivated Stainless Steel

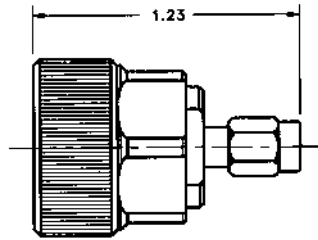

7mm to SSMA Female Jack

Part No.

ADT-2704-7M-SSF-02

Specifications

Frequency:	DC – 18.0 GHz
Impedance:	50 Ohms
VSWR:	1.09
Finish:	Passivated Stainless Steel

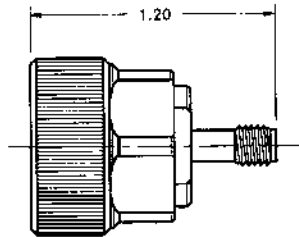

7mm Flange Mount to SSMA Male Plug

Part No.

ADT-2656-7M-SSM-02

Specifications

Frequency:	DC – 18.0 GHz
Impedance:	50 Ohms
VSWR:	1.09
Finish:	Passivated Stainless Steel

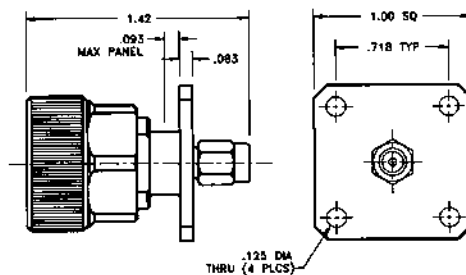

7mm Flange Mount to SSMA Female Jack

Part No.

ADT-2657-7M-SSF-02

Specifications

Frequency:	DC – 18.0 GHz
Impedance:	50 Ohms
VSWR:	1.09
Finish:	Passivated Stainless Steel

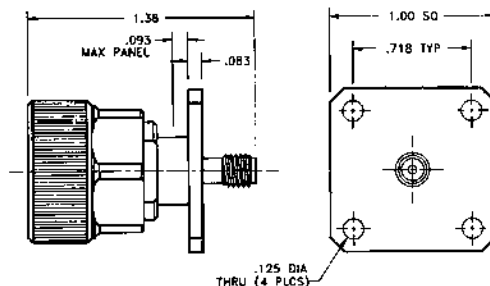

7mm Rebuild Kits

Rebuild Kit for 7mm to SMA Male Plug

Part No.
ADT-2542-7M-SMM-02

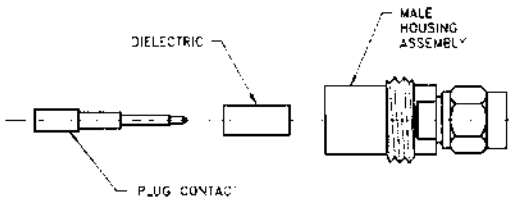

Rebuild Kit for 7mm to 3.5mm Male Plug

Part No.
ADT-2742-7M-3MM-02

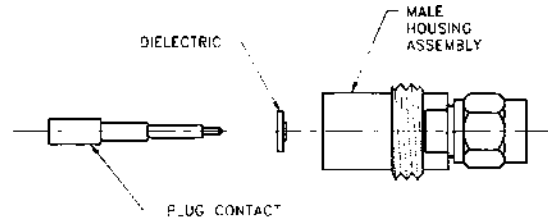

Rebuild Kit for 7mm to SMA Female Jack

Part No.
ADT-2543-7M-SMF-02

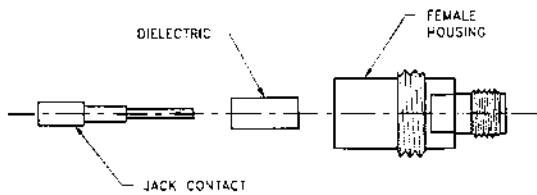

Rebuild Kit for 7mm to 3.5mm Female Jack

Part No.
ADT-2743-7M-3MF-02

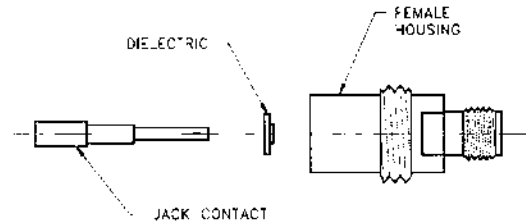

Rebuild Kit for 7mm to SMA Male Plug Long Neck Adapter

Part No.
ADT-2677-7M-SMM-02

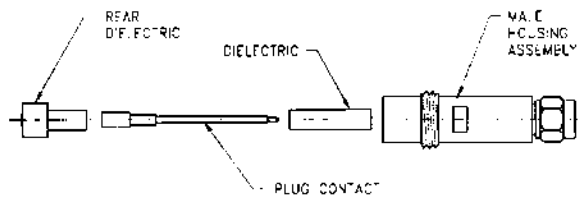

Rebuild Kit for 7mm to SSMA Male Plug

Part No.
ADT-2705-7M-SMM-02

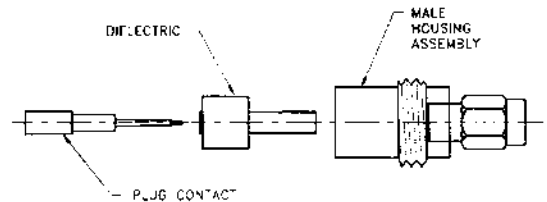

Rebuild Kit for 7mm to SMA Female Jack Long Neck Adapter

Part No.
ADT-2678-7M-SMF-02

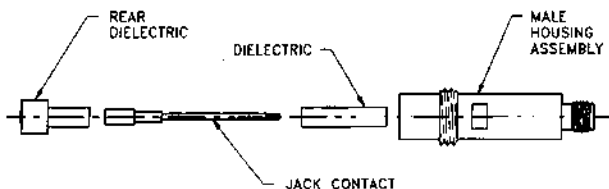

Rebuild Kit for 7mm to SSMA Female Jack

Part No.
ADT-2706-7M-SSF-02

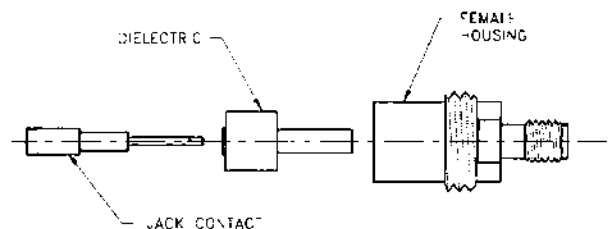

7mm to N Male Plug

Part No.

ADT-2544-7M-NNM-02

Specifications

Frequency:	DC – 18.0 GHz
Impedance:	50 Ohms
VSWR:	1.025 + .0025 f (GHz)
Finish:	Passivated Stainless Steel

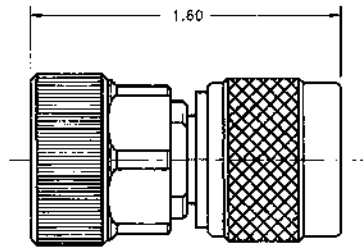

7mm to N Female Jack

Part No.

ADT-2545-7M-NNF-02

Specifications

Frequency:	DC – 18.0 GHz
Impedance:	50 Ohms
VSWR:	1.025 + .0025 f (GHz)
Finish:	Passivated Stainless Steel

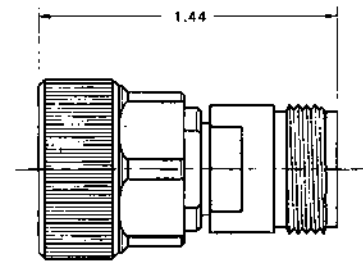

Rebuild Kit for 7mm to N Male Plug

Part No.

ADT-2603-7M-NNM-02

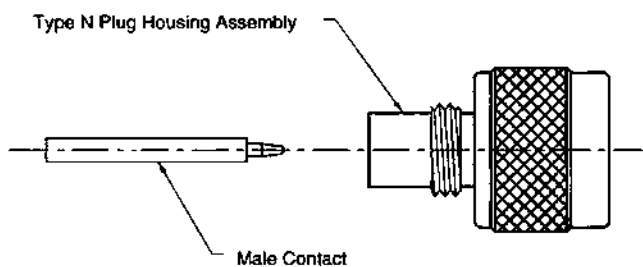

Rebuild Kit for 7mm to N Female Jack

Part No.

ADT-2604-7M-NNF-02

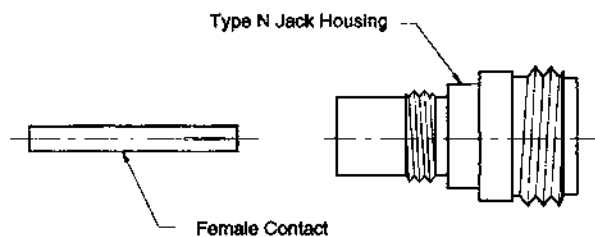

7mm to TNC / 7mm to SC

7mm to TNC Male Plug

Part No.

ADT-2546-7M-TNM-02

Specifications

Frequency:	DC – 18.0 GHz
Impedance:	50 Ohms
VSWR:	1.02 + .006 f (GHz)
Finish:	Passivated Stainless Steel

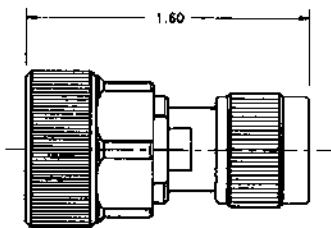

7mm to TNC Female Jack

Part No.

ADT-2547-7M-TNF-02

Specifications

Frequency:	DC – 18.0 GHz
Impedance:	50 Ohms
VSWR:	1.02 + .006 f (GHz)
Finish:	Passivated Stainless Steel

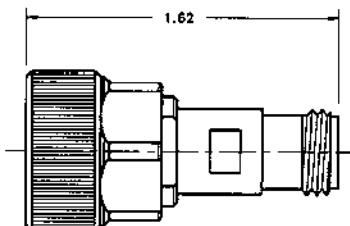

7mm to SC Male Plug

Part No.

ADT-2591-7M-SCM-02

Specifications

Frequency:	DC – 11.0 GHz
Impedance:	50 Ohms
VSWR:	1.04 max @ DC – 4.0 GHz 1.07 max @ 4.0 - 8.0 GHz
Finish:	Passivated Stainless Steel

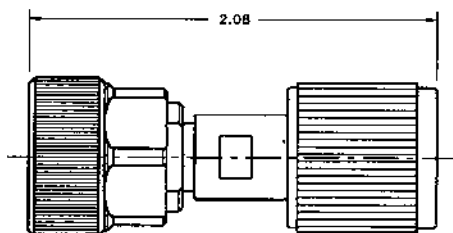

7mm to SC Female Jack

Part No.

ADT-2592-7M-SCF-02

Specifications

Frequency:	DC – 11.0 GHz
Impedance:	50 Ohms
VSWR:	1.04 max @ DC – 4.0 GHz 1.07 max @ 4.0 - 8.0 GHz
Finish:	Passivated Stainless Steel

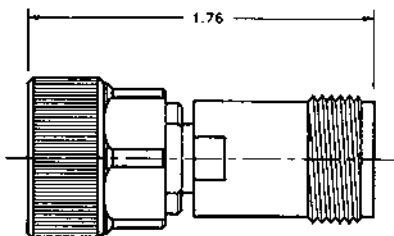

7mm to HN Male Plug

Part No.

ADT-2801-7M-HNM-02

Specifications

Frequency:	DC – 8.0 GHz
Impedance:	50 Ohms
VSWR:	1.10
Finish:	Passivated Stainless Steel

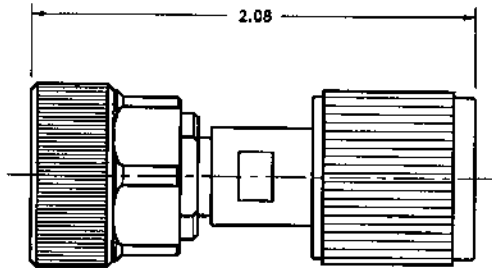

7mm to HN Female Jack

Part No.

ADT-2802-7M-HNF-02

Specifications

Frequency:	DC – 8.0 GHz
Impedance:	50 Ohms
VSWR:	1.10
Finish:	Passivated Stainless Steel

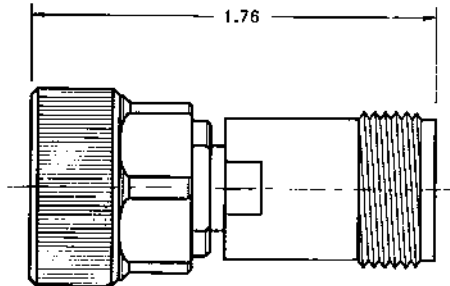

7mm to BMA Male Plug

Part No.

ADT-2761-7M-BMM-02

Specifications

Frequency:	DC – 18.0 GHz
Impedance:	50 Ohms
VSWR:	1.03 + .004f (GHz)
Finish:	Passivated Stainless Steel

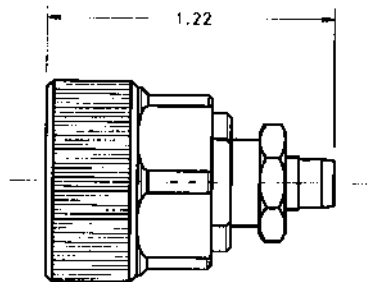

7mm to BMA Female Jack

Part No.

ADT-2762-7M-BMF-02

Specifications

Frequency:	DC – 18.0 GHz
Impedance:	50 Ohms
VSWR:	1.03 + .004f (GHz)
Finish:	Passivated Stainless Steel

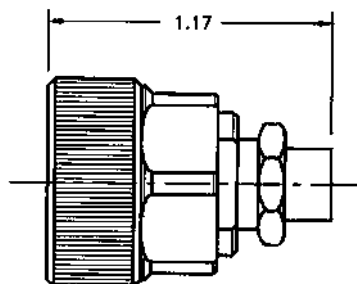

N to 3.5mm

N Male Plug to 3.5mm Male Plug

Part No.

ADT-2712-NM-3MM-02

Specifications

Frequency:	DC – 18.0 GHz
Impedance:	50 Ohms
VSWR:	1.04 @ DC - 4.0 GHz 1.07 @ 4.0-8.0 GHz 1.12 @ 8.0-18.0 GHz
Finish:	Passivated Stainless Steel

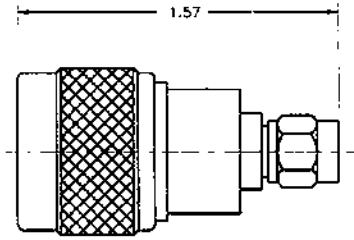

N Male Plug to 3.5mm Female Jack

Part No.

ADT-2713-NM-3MF-02

Specifications

Frequency:	DC – 18.0 GHz
Impedance:	50 Ohms
VSWR:	1.04 @ DC - 4.0 GHz 1.07 @ 4.0-8.0 GHz 1.12 @ 8.0-18.0 GHz
Finish:	Passivated Stainless Steel

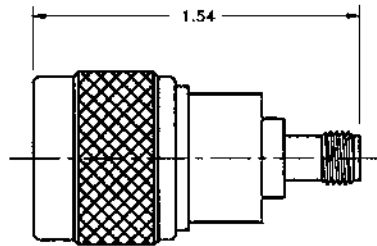

N Female to 3.5mm Male Plug

Part No.

ADT-2714-NF-3MM-02

Specifications

Frequency:	DC – 18.0 GHz
Impedance:	50 Ohms
VSWR:	1.04 @ DC - 4.0 GHz 1.07 @ 4.0-8.0 GHz 1.12 @ 8.0-18.0 GHz
Finish:	Passivated Stainless Steel

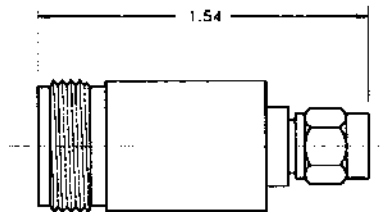

N Female to 3.5mm Female Jack

Part No.

ADT-2715-NF-3MF-02

Specifications

Frequency:	DC – 18.0 GHz
Impedance:	50 Ohms
VSWR:	1.04 @ DC - 4.0 GHz 1.07 @ 4.0-8.0 GHz 1.12 @ 8.0-18.0 GHz
Finish:	Passivated Stainless Steel

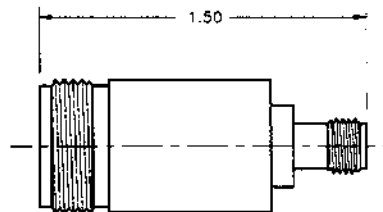

N Male Plug to SMA Male Plug

Part No.

ADT-2580-NM-SMM-02

Specifications

Frequency:	DC – 18.0 GHz
Impedance:	50 Ohms
VSWR:	1.04 @ DC - 4.0 GHz 1.07 @ 4.0-8.0 GHz 1.12 @ 8.0-18.0 GHz
Finish:	Passivated Stainless Steel

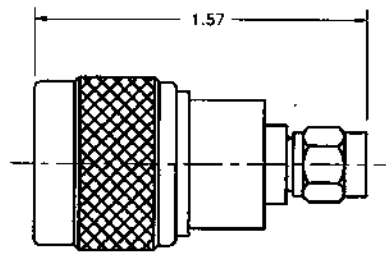

N Male Plug to SMA Female Jack

Part No.

ADT-2581-NM-SMF-02

Specifications

Frequency:	DC – 18.0 GHz
Impedance:	50 Ohms
VSWR:	1.04 @ DC - 4.0 GHz 1.07 @ 4.0-8.0 GHz 1.12 @ 8.0-18.0 GHz
Finish:	Passivated Stainless Steel

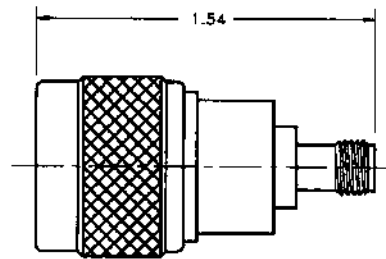

N Female Jack to SMA Male Plug

Part No.

ADT-2582-NF-SMM-02

Specifications

Frequency:	DC – 18.0 GHz
Impedance:	50 Ohms
VSWR:	1.04 @ DC - 4.0 GHz 1.07 @ 4.0-8.0 GHz 1.12 @ 8.0-18.0 GHz
Finish:	Passivated Stainless Steel

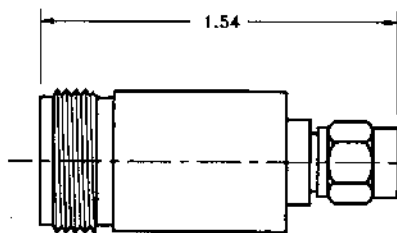

N Female Jack to SMA Female Jack

Part No.

ADT-2583-NF-SMF-02

Specifications

Frequency:	DC – 18.0 GHz
Impedance:	50 Ohms
VSWR:	1.04 @ DC - 4.0 GHz 1.07 @ 4.0-8.0 GHz 1.12 @ 8.0-18.0 GHz
Finish:	Passivated Stainless Steel

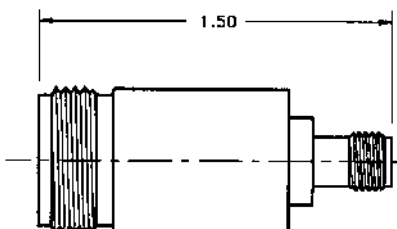

N Flange Mount to SMA

N Flange Mount Male Plug to SMA Male Plug

Part No.

ADT-2576-NM-SMM-02

Specifications

Frequency:	DC – 18.0 GHz
Impedance:	50 Ohms
VSWR:	1.04 @ DC - 4.0 GHz 1.07 @ 4.0-8.0 GHz 1.12 @ 8.0-18.0 GHz
Finish:	Passivated Stainless Steel

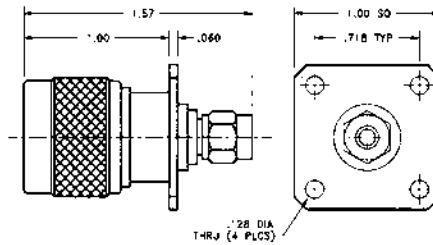

N Flange Mount Male to SMA Female Jack

Part No.

ADT-2577-NM-SMF-02

Specifications

Frequency:	DC – 18.0 GHz
Impedance:	50 Ohms
VSWR:	1.04 @ DC - 4.0 GHz 1.07 @ 4.0-8.0 GHz 1.12 @ 8.0-18.0 GHz
Finish:	Passivated Stainless Steel

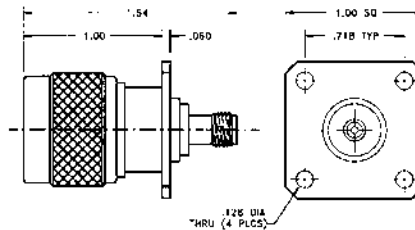

N Flange Mount Female to SMA Male Plug

Part No.

ADT-2578-NF-SMM-02

Specifications

Frequency:	DC – 18.0 GHz
Impedance:	50 Ohms
VSWR:	1.04 @ DC - 4.0 GHz 1.07 @ 4.0-8.0 GHz 1.12 @ 8.0-18.0 GHz
Finish:	Passivated Stainless Steel

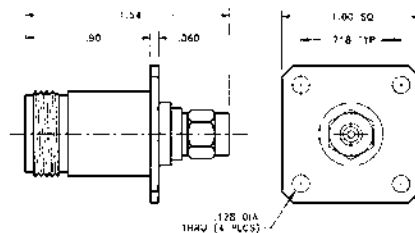

N Flange Mount Female to SMA Female Jack

Part No.

ADT-2579-NF-SMF-02

Specifications

Frequency:	DC – 18.0 GHz
Impedance:	50 Ohms
VSWR:	1.04 @ DC - 4.0 GHz 1.07 @ 4.0-8.0 GHz 1.12 @ 8.0-18.0 GHz
Finish:	Passivated Stainless Steel

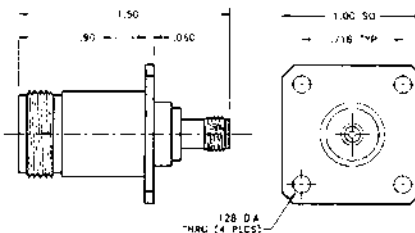

N Bulkhead Female Jack to SMA Male Plug

Part No.

ADT-2810-NF-SMM-02

Specifications

Frequency:	DC – 18.0 GHz
Impedance:	50 Ohms
VSWR:	1.20 max
Finish:	Passivated Stainless Steel

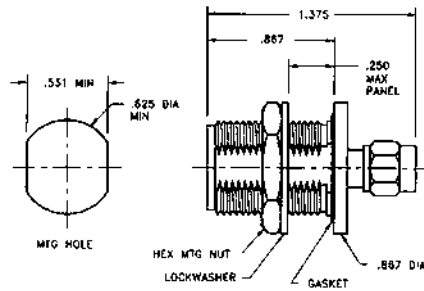

N Bulkhead Female Jack to SMA Female Plug

Part No.

ADT-2840-NF-SMF-02

Specifications

Frequency:	DC – 18.0 GHz
Impedance:	50 Ohms
VSWR:	1.20 max
Finish:	Passivated Stainless Steel

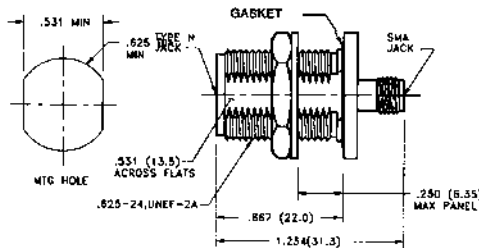

N Rear Mount Bulkhead Female Jack to SMA Male Plug

Part No.

ADT-2599-NF-SMM-02

Specifications

Frequency:	DC – 18.0 GHz
Impedance:	50 Ohms
VSWR:	1.20 max
Finish:	Passivated Stainless Steel

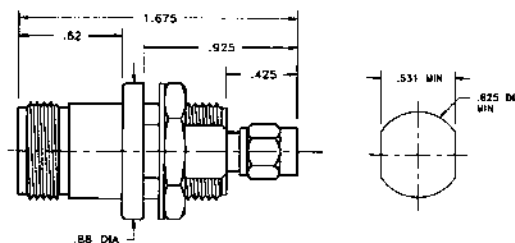

N Rear Mount Bulkhead Female Jack to SMA Female Jack

Part No.

ADT-2599-NF-SMF-02

Specifications

Frequency:	DC – 18.0 GHz
Impedance:	50 Ohms
VSWR:	1.04 @ DC - 4.0 GHz 1.07 @ 4.0-8.0 GHz 1.12 @ 8.0-18.0 GHz
Finish:	Passivated Stainless Steel

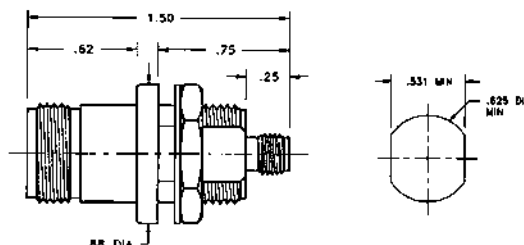

N to SSMA

N Male Plug to SSMA Male Plug

Part No.

ADT-2690-NM-SSM-02

Specifications

Frequency:	DC – 18.0 GHz
Impedance:	50 Ohms
VSWR:	1.20 max
Finish:	Passivated Stainless Steel

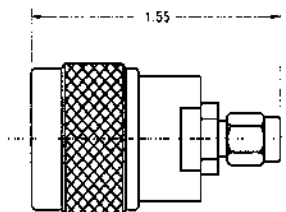

N Male Plug to SSMA Female Jack

Part No.

ADT-2691-NM-SSF-02

Specifications

Frequency:	DC – 18.0 GHz
Impedance:	50 Ohms
VSWR:	1.20 max
Finish:	Passivated Stainless Steel

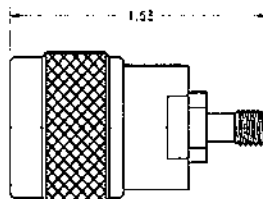

N Female to SSMA Male Plug

Part No.

ADT-2692-NF-SSM-02

Specifications

Frequency:	DC – 18.0 GHz
Impedance:	50 Ohms
VSWR:	1.20 max
Finish:	Passivated Stainless Steel

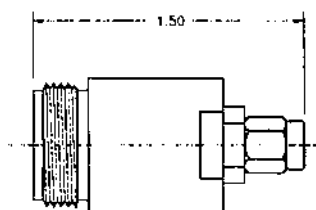

N Female to SSMA Female Jack

Part No.

ADT-2693-NF-SSF-02

Specifications

Frequency:	DC – 18.0 GHz
Impedance:	50 Ohms
VSWR:	1.20 max
Finish:	Passivated Stainless Steel

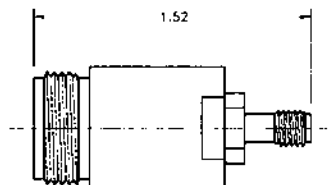

N Flange Mount Male Plug to SSMA Male Plug

Part No.

ADT-2811-NM-SSM-02

Specifications

Frequency:	DC – 18.0 GHz
Impedance:	50 Ohms
VSWR:	1.20 max
Finish:	Passivated Stainless Steel

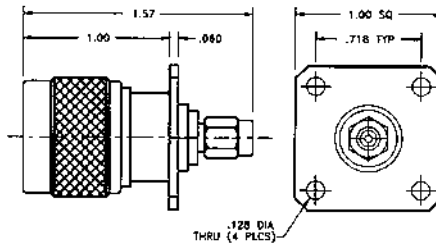

N Flange Mount Male Plug to SSMA Male Plug

Part No.

ADT-2812-NM-SSF-02

Specifications

Frequency:	DC – 18.0 GHz
Impedance:	50 Ohms
VSWR:	1.20 max
Finish:	Passivated Stainless Steel

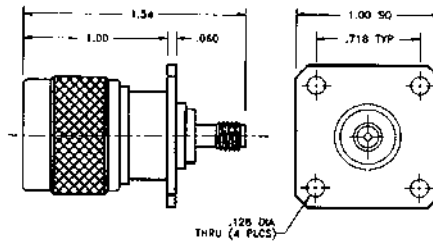

N Flange Mount Female Jack to SSMA Male Plug

Part No.

ADT-2813-NF-SSM-02

Specifications

Frequency:	DC – 18.0 GHz
Impedance:	50 Ohms
VSWR:	1.20 max
Finish:	Passivated Stainless Steel

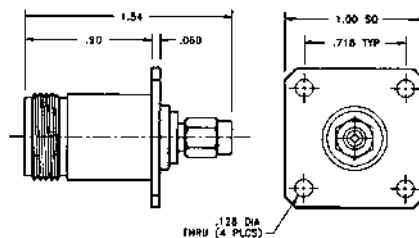

N Flange Mount Female Jack to SSMA Female Jack

Part No.

ADT-2814-NF-SSF-02

Specifications

Frequency:	DC – 18.0 GHz
Impedance:	50 Ohms
VSWR:	1.20 max
Finish:	Passivated Stainless Steel

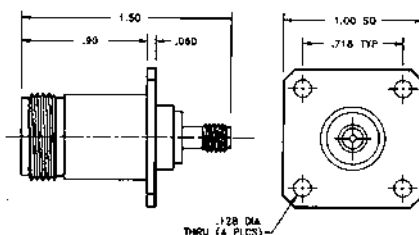

N to SMA / Economical

N Male Plug to SMA Male Plug

Part No.

ADT-2680-NM-SMM-02

Specifications

Frequency:	DC – 18.0 GHz
Impedance:	50 Ohms
VSWR:	1.25 max
Finish:	Passivated Stainless Steel

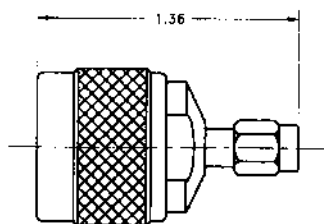

N Male Plug to SMA Female Jack

Part No.

ADT-2681-NM-SMF-02

Specifications

Frequency:	DC – 18.0 GHz
Impedance:	50 Ohms
VSWR:	1.25 max
Finish:	Passivated Stainless Steel

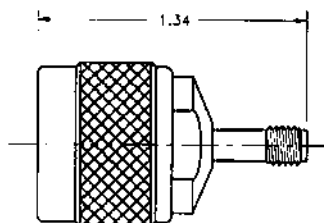

N Female to SMA Male Plug

Part No.

ADT-2682-NF-SMM-02

Specifications

Frequency:	DC – 18.0 GHz
Impedance:	50 Ohms
VSWR:	1.25 max
Finish:	Passivated Stainless Steel

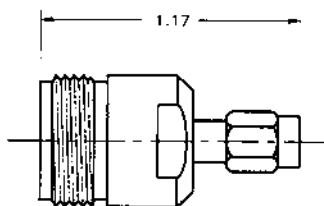

N Female to SMA Female Jack

Part No.

ADT-2683-NF-SMF-02

Specifications

Frequency:	DC – 18.0 GHz
Impedance:	50 Ohms
VSWR:	1.25 max
Finish:	Passivated Stainless Steel

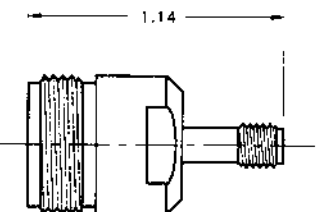

N Male Plug to SSMA Male Plug

Part No.	
ADT-2816-NM-SSM-02	

Specifications	
Frequency:	DC – 18.0 GHz
Impedance:	50 Ohms
VSWR:	1.20
Finish:	Passivated Stainless Steel

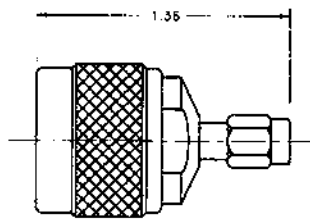

N Male Plug to SSMA Female Jack

Part No.	
ADT-2817-NM-SSF-02	

Specifications	
Frequency:	DC – 18.0 GHz
Impedance:	50 Ohms
VSWR:	1.20
Finish:	Passivated Stainless Steel

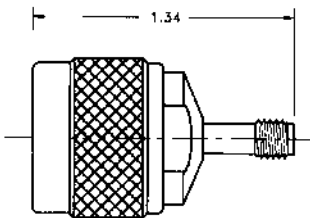

N Female Jack to SSMA Male Plug

Part No.	
ADT-2818-NF-SSM-02	

Specifications	
Frequency:	DC – 18.0 GHz
Impedance:	50 Ohms
VSWR:	1.20
Finish:	Passivated Stainless Steel

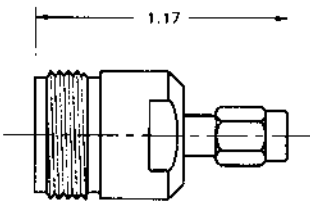

N Female Jack to SSMA Female Jack

Part No.	
ADT-2819-NF-SSF-02	

Specifications	
Frequency:	DC – 18.0 GHz
Impedance:	50 Ohms
VSWR:	1.20
Finish:	Passivated Stainless Steel

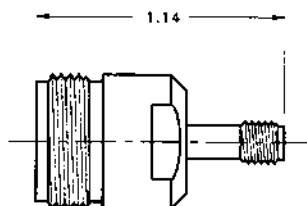

N to TNC

N Male Plug to TNC Male Plug

Part No.

ADT-2584-NM-TNM-02

Specifications

Frequency:	DC – 18.0 GHz
Impedance:	50 Ohms
VSWR:	1.04 @ DC - 4.0 GHz
	1.07 @ 4.0-8.0 GHz
	1.12 @ 8.0-18.0 GHz
Finish:	Passivated Stainless Steel

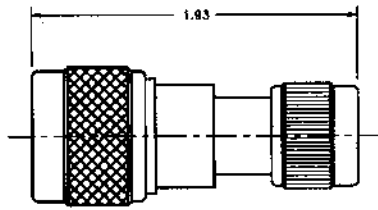

N Male Plug to TNC Female Jack

Part No.

ADT-2585-NM-TNF-02

Specifications

Frequency:	DC – 18.0 GHz
Impedance:	50 Ohms
VSWR:	1.04 @ DC - 4.0 GHz
	1.07 @ 4.0-8.0 GHz
	1.12 @ 8.0-18.0 GHz
Finish:	Passivated Stainless Steel

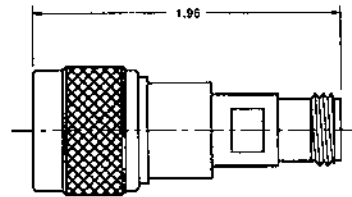

N Female to TNC Male Plug

Part No.

ADT-2586-NF-TNM-02

Specifications

Frequency:	DC – 18.0 GHz
Impedance:	50 Ohms
VSWR:	1.04 @ DC - 4.0 GHz
	1.07 @ 4.0-8.0 GHz
	1.12 @ 8.0-18.0 GHz
Finish:	Passivated Stainless Steel

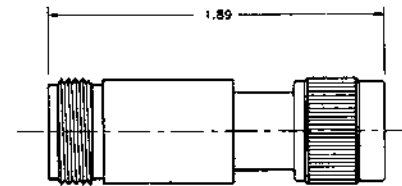

N Female to TNC Female Jack

Part No.

ADT-2587-NF-TNF-02

Specifications

Frequency:	DC – 18.0 GHz
Impedance:	50 Ohms
VSWR:	1.04 @ DC - 4.0 GHz
	1.07 @ 4.0-8.0 GHz
	1.12 @ 8.0-18.0 GHz
Finish:	Passivated Stainless Steel

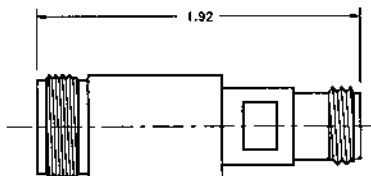

N Male Plug to BNC Male Plug

Part No.

ADT-2613-NM-BNM-02

Specifications

Frequency:	DC – 4.0 GHz
Impedance:	50 Ohms
VSWR:	1.25
Finish:	Type N – Passivated Stainless Steel BNC – Nickel Plated Brass

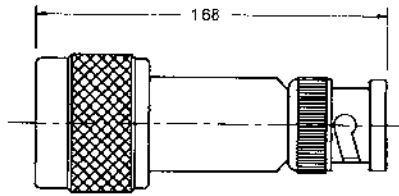

N Male Plug to BNC Female Jack

Part No.

ADT-2614-NM-BNF-02

Specifications

Frequency:	DC – 4.0 GHz
Impedance:	50 Ohms
VSWR:	1.25
Finish:	Type N – Passivated Stainless Steel BNC – Nickel Plated Brass

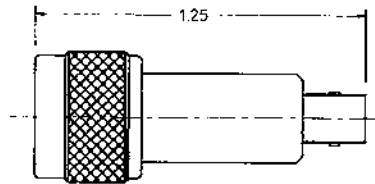

N Female Jack to BNC Male Plug

Part No.

ADT-2615-NF-BNM-02

Specifications

Frequency:	DC – 4.0 GHz
Impedance:	50 Ohms
VSWR:	1.25
Finish:	Type N – Passivated Stainless Steel BNC – Nickel Plated Brass

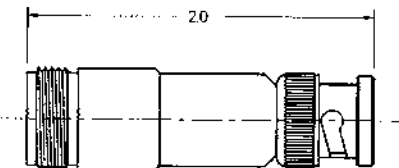

N Female Jack to BNC Female Jack

Part No.

ADT-2616-NF-BNF-02

Specifications

Frequency:	DC – 4.0 GHz
Impedance:	50 Ohms
VSWR:	1.25
Finish:	Type N – Passivated Stainless Steel BNC – Nickel Plated Brass

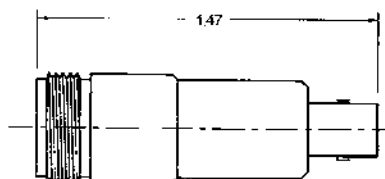

N to SC

N Male Plug to SC Male Plug

Part No.

ADT-2618-NM-SCM-02

Specifications

Frequency:	DC – 11.0 GHz
Impedance:	50 Ohms
VSWR:	1.08 @ DC - 4.0 GHz 1.20 @ 4.0-8.0 GHz
Finish:	Passivated Stainless Steel

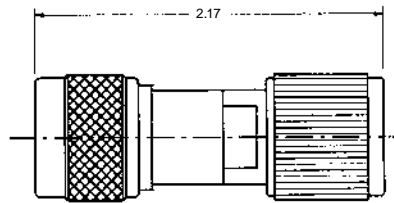

N Female Jack to SC Male Jack

Part No.

ADT-2619-NF-SCM-02

Specifications

Frequency:	DC – 11.0 GHz
Impedance:	50 Ohms
VSWR:	1.08 @ DC - 4.0 GHz 1.20 @ 4.0-8.0 GHz
Finish:	Passivated Stainless Steel

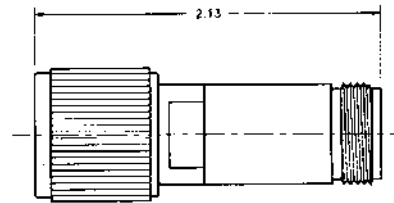

N Male Plug to SC Female Jack

Part No.

ADT-2638-NM-SCF-02

Specifications

Frequency:	DC – 8.0 GHz
Impedance:	50 Ohms
VSWR:	1.2
Finish:	Passivated Stainless Steel

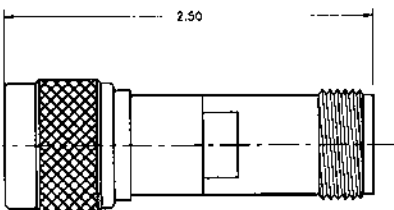

N Female Jack to SC Female Jack

Part No.

ADT-2639-NF-SCF-02

Specifications

Frequency:	DC – 8.0 GHz
Impedance:	50 Ohms
VSWR:	1.2
Finish:	Passivated Stainless Steel



N Male Plug to HN Male Plug

Part No.	
ADT-2803-NM-HNM-02	

Specifications	
Frequency:	DC – 8.0 GHz
Impedance:	50 Ohms
VSWR:	1.08 @ DC - 4.0 GHz 1.20 @ 4.0-8.0 GHz
Finish:	Passivated Stainless Steel

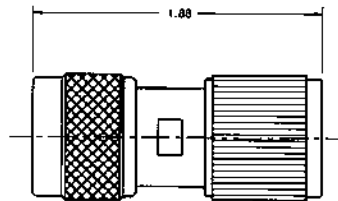

N Female Jack to HN Male Plug

Part No.	
ADT-2804-NF-HNM-02	

Specifications	
Frequency:	DC – 4.0 GHz
Impedance:	50 Ohms
VSWR:	1.08 @ DC - 4.0 GHz 1.20 @ 4.0-8.0 GHz
Finish:	Passivated Stainless Steel

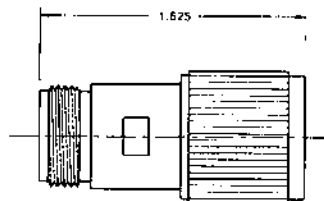

N Male Plug to HN Female Jack

Part No.	
ADT-2791-NM-HNF-02	

Specifications	
Frequency:	DC – 8.0 GHz
Impedance:	50 Ohms
VSWR:	1.08 @ DC - 4.0 GHz 1.20 @ 4.0-8.0 GHz
Finish:	Passivated Stainless Steel

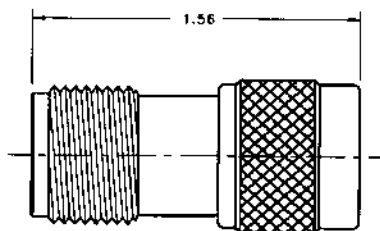

N Female Jack to HN Female Jack

Part No.	
ADT-2790-NF-HNF-02	

Specifications	
Frequency:	DC – 8.0 GHz
Impedance:	50 Ohms
VSWR:	1.08 @ DC - 4.0 GHz 1.20 @ 4.0-8.0 GHz
Finish:	Passivated Stainless Steel

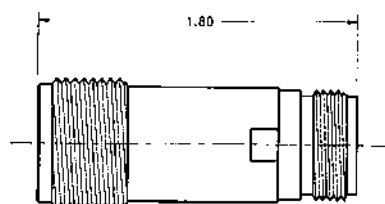

TNC to SMA

TNC Male Plug to SMA Male Plug

Part No.

ADT-2685-TM-SMM-02

Specifications

Frequency:	DC – 18.0 GHz
Impedance:	50 Ohms
VSWR:	1.07 + .015f GHz
Finish:	Passivated Stainless Steel

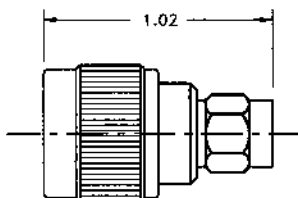

TNC Male Plug to SMA Female Jack

Part No.

ADT-2686-TM-SMF-02

Specifications

Frequency:	DC – 18.0 GHz
Impedance:	50 Ohms
VSWR:	1.07 + .015f GHz
Finish:	Passivated Stainless Steel

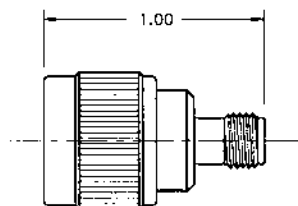

TNC Female Jack to SMA Male Plug

Part No.

ADT-2687-TF-SMM-02

Specifications

Frequency:	DC – 18.0 GHz
Impedance:	50 Ohms
VSWR:	1.07 + .015f GHz
Finish:	Passivated Stainless Steel

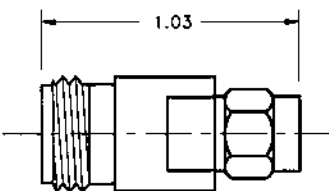

TNC Female Jack to SMA Female Jack

Part No.

ADT-2688-TF-SMF-02

Specifications

Frequency:	DC – 18.0 GHz
Impedance:	50 Ohms
VSWR:	1.07 + .015f GHz
Finish:	Passivated Stainless Steel

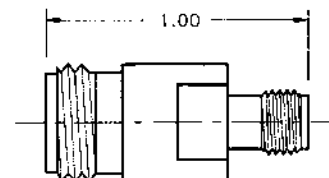

TNC Bulkhead Female Jack to SMA Male Plug

Part No.

ADT-2815-TF-SMM-02

Specifications

Frequency:	DC – 18.0 GHz
Impedance:	50 Ohms
VSWR:	1.07 + .015f GHz
Finish:	Passivated Stainless Steel

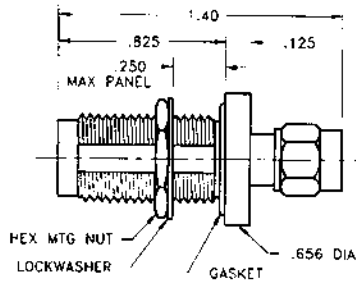

TNC Bulkhead Female Jack to SMA Female Jack

Part No.

ADT-2793-TF-SMF-02

Specifications

Frequency:	DC – 18.0 GHz
Impedance:	50 Ohms
VSWR:	1.07 + .015f GHz
Finish:	Passivated Stainless Steel

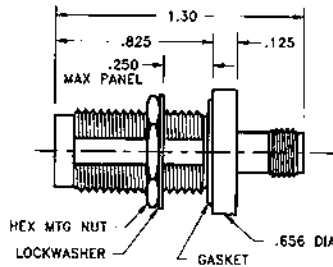

TNC Flange Mount Female Jack to SMA Male Plug

Part No.

ADT-2689-TF-SMM-02

Specifications

Frequency:	DC – 18.0 GHz
Impedance:	50 Ohms
VSWR:	1.07 + .015f GHz
Finish:	Passivated Stainless Steel

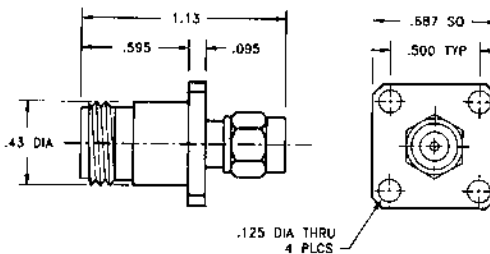

TNC Flange Mount Female Jack to SMA Female Jack

Part No.

ADT-2699-TF-SMF-02

Specifications

Frequency:	DC – 18.0 GHz
Impedance:	50 Ohms
VSWR:	1.07 + .015f GHz
Finish:	Passivated Stainless Steel

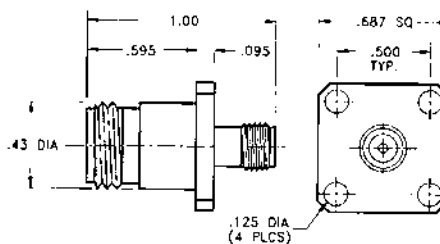

BNC to SMA

BNC Male Plug to SMA Male Plug

Part No.

ADT-2670-BM-SMM-02

Specifications

Frequency:	DC – 8.0 GHz
Impedance:	50 Ohms
VSWR:	1.15 @ DC - 4.0 GHz 1.25 @ 4.0-8.0 GHz
Finish:	Passivated Stainless Steel BNC Housing Nickel Plated Brass

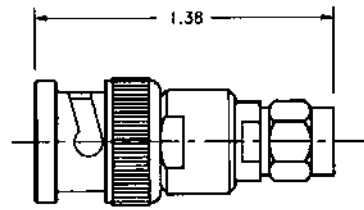

BNC Male Plug to SMA Female Jack

Part No.

ADT-2671-BM-SMF-02

Specifications

Frequency:	DC – 8.0 GHz
Impedance:	50 Ohms
VSWR:	1.15 @ DC - 4.0 GHz 1.25 @ 4.0-8.0 GHz
Finish:	Passivated Stainless Steel BNC Housing Nickel Plated Brass

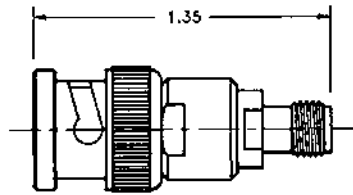

BNC Female Plug to SMA Male Plug

Part No.

ADT-2672-BF-SMM-02

Specifications

Frequency:	DC – 8.0 GHz
Impedance:	50 Ohms
VSWR:	1.15 @ DC - 4.0 GHz 1.25 @ 4.0-8.0 GHz
Finish:	Passivated Stainless Steel BNC Housing Nickel Plated Brass

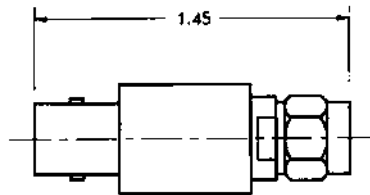

BNC Female Jack to SMA Female Jack

Part No.

ADT-2673-BF-SMF-02

Specifications

Frequency:	DC – 8.0 GHz
Impedance:	50 Ohms
VSWR:	1.15 @ DC - 4.0 GHz 1.25 @ 4.0-8.0 GHz
Finish:	Passivated Stainless Steel BNC Housing Nickel Plated Brass

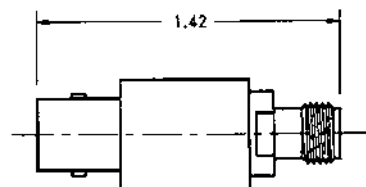

SMA Male Plug to SSMA Male Plug

Part No.

ADT-2695-SM-SSM-02

Specifications

Frequency:	DC – 25.0 GHz
Impedance:	50 Ohms
VSWR:	1.06 + .009f (GHz) @ DC - 12.4 GHz 1.05 + .01f (GHz) @ 12.4-25.0 GHz
Finish:	Passivated Stainless Steel

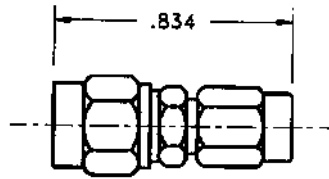

SMA Male Plug to SSMA Female Jack

Part No.

ADT-2696-SM-SSF-02

Specifications

Frequency:	DC – 25.0 GHz
Impedance:	50 Ohms
VSWR:	1.06 + .009f (GHz) @ DC - 12.4 GHz 1.05 + .01f (GHz) @ 12.4-25.0 GHz
Finish:	Passivated Stainless Steel

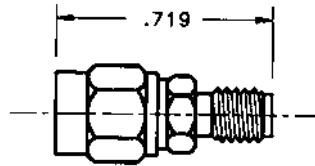

SMA Female Jack to SSMA Male Plug

Part No.

ADT-2697-SF-SSM-02

Specifications

Frequency:	DC – 25.0 GHz
Impedance:	50 Ohms
VSWR:	1.06 + .009f (GHz) @ DC - 12.4 GHz 1.05 + .01f (GHz) @ 12.4-25.0 GHz
Finish:	Passivated Stainless Steel

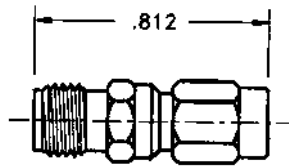

SMA Female Jack to SSMA Female Jack

Part No.

ADT-2698-SF-SSF-02

Specifications

Frequency:	DC – 25.0 GHz
Impedance:	50 Ohms
VSWR:	1.06 + .009f (GHz) @ DC - 12.4 GHz 1.05 + .01f (GHz) @ 12.4-25.0 GHz
Finish:	Passivated Stainless Steel

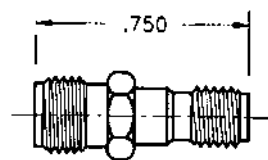

SMA to SMM

SMA Male Plug to SMM Male Plug

Part No.

ADT-2848-SM-MMM-02

Specifications

Frequency:	DC – 18.0 GHz
Impedance:	50 Ohms
VSWR:	1.04 + .007 f (GHz)
Finish:	Passivated Stainless Steel

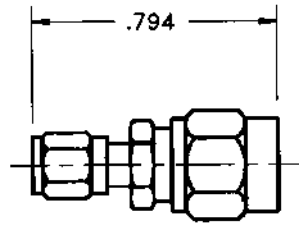

SMA Male Plug to SMM Female Jack

Part No.

ADT-2846-SM-MMF-02

Specifications

Frequency:	DC – 18.0 GHz
Impedance:	50 Ohms
VSWR:	1.04 + .007 f (GHz)
Finish:	Passivated Stainless Steel

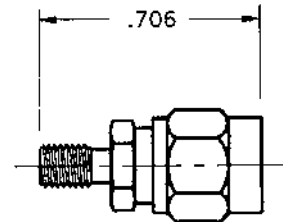

SMA Female Jack to SMM Female Jack

Part No.

ADT-2845-SF-MMF-02

Specifications

Frequency:	DC – 18.0 GHz
Impedance:	50 Ohms
VSWR:	1.04 + .007 f (GHz)
Finish:	Passivated Stainless Steel

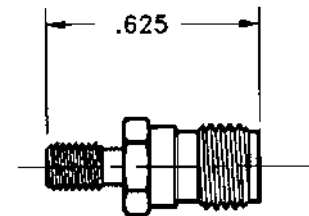

SMA Female Jack to SMM Male Plug

Part No.

ADT-2847-SF-MMM-02

Specifications

Frequency:	DC – 18.0 GHz
Impedance:	50 Ohms
VSWR:	1.04 + .007 f (GHz)
Finish:	Passivated Stainless Steel

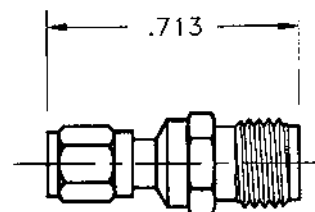

SMA Male Plug to BMA Female Jack

Part No.

ADT-2768-SM-BMF-02

Specifications

Frequency:	DC – 18.0 GHz
Impedance:	50 Ohms
VSWR:	1.05 + .005f (GHz)
Finish:	Passivated Stainless Steel

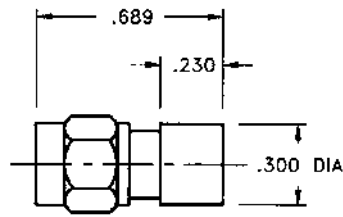

SMA Bulkhead Female Jack to BMA Female Jack

Part No.

ADT-2805-SF-BMF-02

Specifications

Frequency:	DC – 18.0 GHz
Impedance:	50 Ohms
VSWR:	1.05 + .005f (GHz)
Finish:	Passivated Stainless Steel

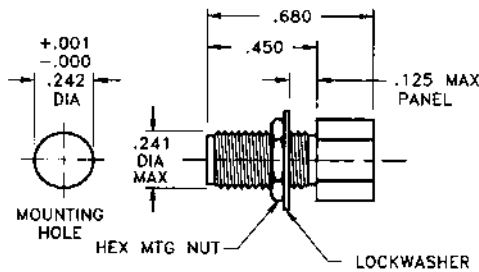

SMA Female Jack to BMA Female Jack – Bulkhead Mount

Part No.

ADT-2806-SF-BMF-02

Specifications

Frequency:	DC – 18.0 GHz
Impedance:	50 Ohms
VSWR:	1.05 + .005f (GHz)
Finish:	Passivated Stainless Steel

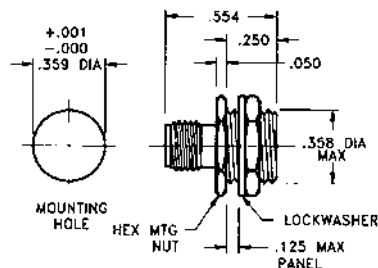

SMA Male Plug to BMA Female Jack – Bulkhead Mount

Part No.

ADT-2807-SM-BMF-02

Specifications

Frequency:	DC – 18.0 GHz
Impedance:	50 Ohms
VSWR:	1.05 + .005f (GHz)
Finish:	Passivated Stainless Steel

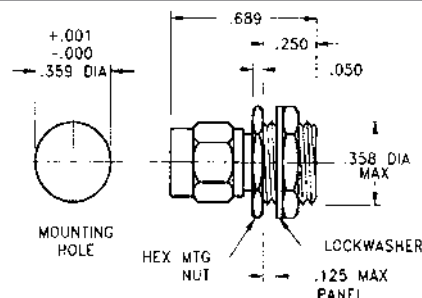

SMA to BMA

SMA Female Jack to BMA Male Plug

Part No.

ADT-2769-SF-BMM-02

Specifications

Frequency:	DC – 18.0 GHz
Impedance:	50 Ohms
VSWR:	1.05 + .005 f (GHz)
Finish:	Passivated Stainless Steel

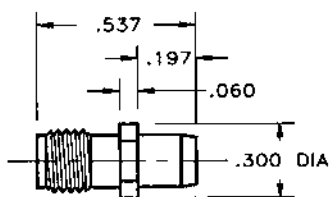

SMA Female Jack to BMA Male Plug – Bulkhead Mount

Part No.

ADT-2797-SF-BMM-02

Specifications

Frequency:	DC – 18.0 GHz
Impedance:	50 Ohms
VSWR:	1.05 + .005 f (GHz)
Finish:	Passivated Stainless Steel

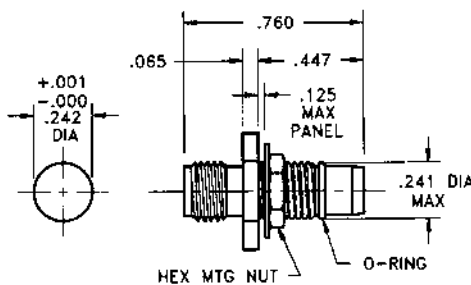

SMA Male Plug to BMA Male Plug

Part No.

ADT-2770-SM-BMM-02

Specifications

Frequency:	DC – 18.0 GHz
Impedance:	50 Ohms
VSWR:	1.05 + .005 f (GHz)
Finish:	Passivated Stainless Steel

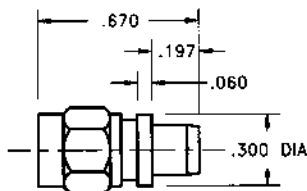

SMA Male Plug to BMA Male Plug – Bulkhead Mount

Part No.

ADT-2798-SM-BMM-02

Specifications

Frequency:	DC – 18.0 GHz
Impedance:	50 Ohms
VSWR:	1.05 + .005 f (GHz)
Finish:	Passivated Stainless Steel

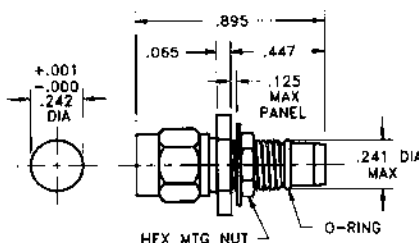

SMA Female Jack to BMA Female Jack

Part No.

ADT-2767-SF-BMF-02

Specifications

Frequency:	DC – 18.0 GHz
Impedance:	50 Ohms
VSWR:	1.05 + .005f (GHz)
Finish:	Passivated Stainless Steel

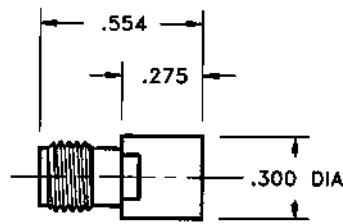

SMA Female Jack to BMA Female Jack – Floating Panel Mount

Part No.

ADT-2808-SF-BMF-02

Specifications

Frequency:	DC – 18.0 GHz
Impedance:	50 Ohms
VSWR:	1.05 + .005f (GHz)
Finish:	Passivated Stainless Steel

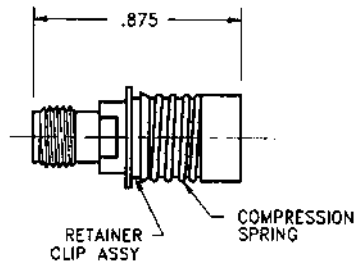

SMA Female Jack to BMA Female Jack – Floating Panel Mount

Part No.

ADT-2809-SF-BMF-02

Specifications

Frequency:	DC – 18.0 GHz
Impedance:	50 Ohms
VSWR:	1.05 + .005f (GHz)
Finish:	Passivated Stainless Steel

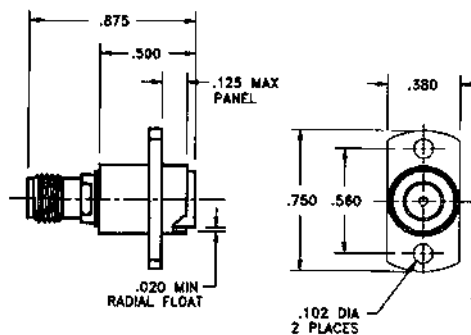

Table of Contents

In-Series Adapters

SMA Types.....	117
3.5mm Types	119
2.9mm Types	120
N Type.....	121
TNC Types	122
BNC Types	123
SC Types.....	124
HN Type	125
Special Adapters	126

3 Attenuators

31 Terminations

58 DC Blocks

61 Couplers

73 Power Dividers

81 Equalizers

85 Phase Shifters

87 Between Series Adapters

116 In-Series Adapters

127 Connectors

**177 QPL Approved Products &
Tools for Assembly**

200 Appendix

209 Index

SMA Male Plug to SMA Male Plug

Part No.	
ADT-2593-MF-SMA-02	

Specifications	
Frequency:	DC – 18.0 GHz
Impedance:	50 Ohms
VSWR:	1.05 + .005 f (GHz)
Finish:	Passivated Stainless Steel

Note: Also available in 0.720 (18.2) O.A.L. as ADT-8000-22-SMA-02

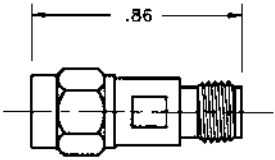

SMA Female Jack to SMA Female Jack

Part No.	
ADT-2595-FF-SMA-02	

Specifications	
Frequency:	DC – 18.0 GHz
Impedance:	50 Ohms
VSWR:	1.05 + .005 f (GHz)
Finish:	Passivated Stainless Steel

Note: Also available with knurled center section (0.875 O.A.L.) as ADT-2841-FF-SMA-02 and in 0.500 (12.7) O.A.L. with fully threaded barrel as ADT-8000-20-SMA-02

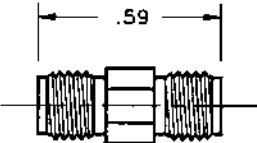

SMA Male Plug to SMA Male Plug

Part No.	
ADT-2594-MM-SMA-02	

Specifications	
Frequency:	DC – 18.0 GHz
Impedance:	50 Ohms
VSWR:	1.05 + .005 f (GHz)
Finish:	Passivated Stainless Steel

Note: Also available in 0.875 (22.2) O.A.L. as ADT-8000-21-SMA-02

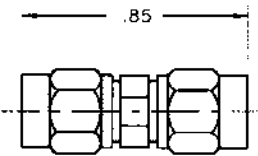

SMA Female Jack to SMA Female Jack – Bulkhead Mount

Part No.	
ADT-2823-FF-SMA-02	

Specifications	
Frequency:	DC – 18.0 GHz
Impedance:	50 Ohms
VSWR:	1.05 + .005 f (GHz)
Finish:	Passivated Stainless Steel

Formerly SMA-024-8000 and SMA-8000-24-000-02

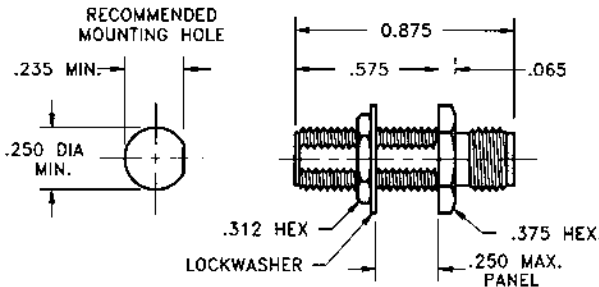

SMA Types

Right Angle SMA Male Plug to SMA Female Jack

Part No.

ADT-8000-MF-SMA-02

Specifications

Frequency:	DC – 18.0 GHz
Impedance:	50 Ohms
VSWR:	1.05 + .010 f (GHz)
Finish:	Passivated Stainless Steel

Formerly SMA-028-8000 and SMA-8000-28-000-02

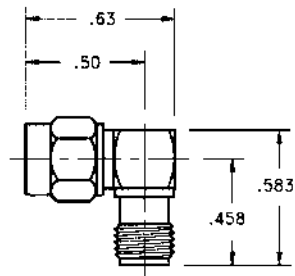

Right Angle SMA Female Jack to SMA Female Jack

Part No.

ADT-8000-FF-SMA-02

Specifications

Frequency:	DC – 18.0 GHz
Impedance:	50 Ohms
VSWR:	1.05 + .010 f (GHz)
Finish:	Passivated Stainless Steel

Formerly SMA-026-8000 and SMA-8000-26-000-02

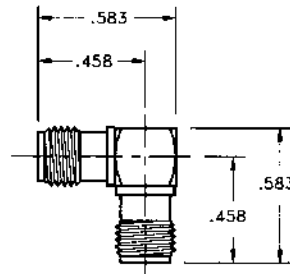

Right Angle SMA Male Plug to SMA Male Plug

Part No.

ADT-8000-MM-SMA-02

Specifications

Frequency:	DC – 18.0 GHz
Impedance:	50 Ohms
VSWR:	1.05 + .010 f (GHz)
Finish:	Passivated Stainless Steel

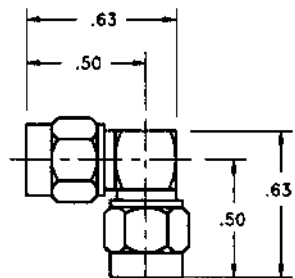

SMA Female Jack to SMA Female Jack – Blkhhd Mount – Hermetic

Part No.

ADT-2824-FF-SMA-02

Specifications

Frequency:	DC – 18.0 GHz
Impedance:	50 Ohms
VSWR:	1.05 + .010 f (GHz)
Finish:	Passivated Stainless Steel

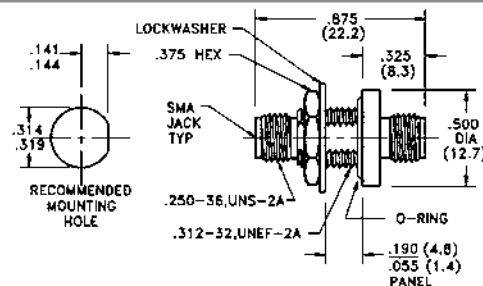

3.5mm Male Plug to 3.5mm Female Jack

Part No.

ADT-2733-MF-3MM-02

Specifications

Frequency:	DC – 26.5 GHz
Impedance:	50 Ohms
VSWR:	DC - 20 GHz: 1.10 20-26.5 GHz: 1.15
Finish:	Passivated Stainless Steel

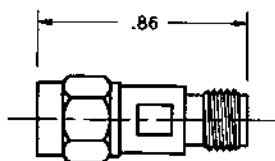

3.5mm Female Jack to 3.5mm Female Jack

Part No.

ADT-2735-FF-3MM-02

Specifications

Frequency:	DC – 26.5 GHz
Impedance:	50 Ohms
VSWR:	DC - 20 GHz: 1.10 20-26.5 GHz: 1.15
Finish:	Passivated Stainless Steel

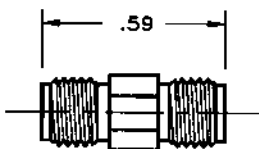

3.5mm Male Plug to 3.5mm Male Plug

Part No.

ADT-2734-MM-3MM-02

Specifications

Frequency:	DC – 26.5 GHz
Impedance:	50 Ohms
VSWR:	DC - 20 GHz: 1.10 20-26.5 GHz: 1.15
Finish:	Passivated Stainless Steel

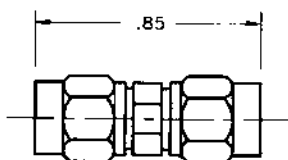

3.5mm Female Jack to 3.5mm Female Jack – Bulkhead Mount

Part No.

ADT-2850-FF-35M-02

Specifications

Frequency:	DC – 26.5 GHz
Impedance:	50 Ohms
VSWR:	1.05 + .005 f (GHz)
Finish:	Passivated Stainless Steel

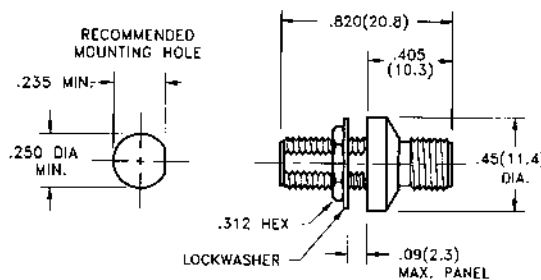

2.9mm Types

2.9mm Male Plug to 2.9mm Female Jack

Part No.

ADT-2851-MF-29M-00

Specifications

Frequency:	DC – 40.0 GHz
Impedance:	50 Ohms
VSWR:	1.20
Finish:	Gold Plated Stainless Steel

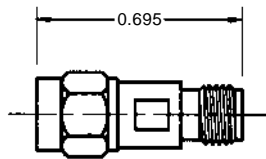

2.9mm Female Jack to 2.9mm Female Jack

Part No.

ADT-2852-FF-29M-00

Specifications

Frequency:	DC – 40.0 GHz
Impedance:	50 Ohms
VSWR:	1.20
Finish:	Gold Plated Stainless Steel

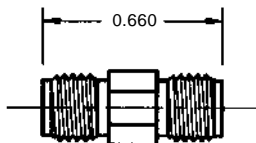

2.9mm Male Plug to 2.9mm Male Plug

Part No.

ADT-2853-MM-29M-00

Specifications

Frequency:	DC – 40.0 GHz
Impedance:	50 Ohms
VSWR:	1.20
Finish:	Gold Plated Stainless Steel

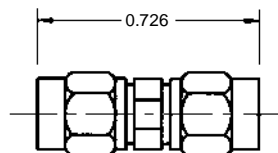

2.9mm Female Jack to 2.9mm Female Jack – Bulkhead Mount

Part No.

ADT-2854-FF-29M-02

Specifications

Frequency:	DC – 25.5 GHz
Impedance:	50 Ohms
VSWR:	1.20
Finish:	Passivated Stainless Steel

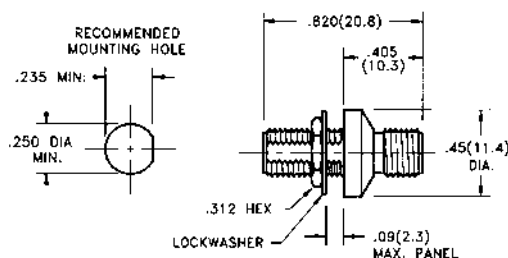

N Male Plug to N Female Jack

Part No.

ADT-2588-MF-NNN-02

Specifications

Frequency:	DC – 18.0 GHz
Impedance:	50 Ohms
VSWR:	1.04 @ DC - 4.0 GHz 1.06 @ 4.0-8.0 GHz 1.10 @ 8.0-18.0 GHz
Finish:	Passivated Stainless Steel

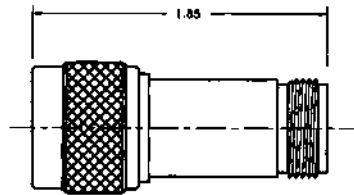

N Female Jack to N Female Jack

Part No.

ADT-2590-FF-NNN-02

Specifications

Frequency:	DC – 18.0 GHz
Impedance:	50 Ohms
VSWR:	1.04 @ DC - 4.0 GHz 1.06 @ 4.0-8.0 GHz 1.10 @ 8.0-18.0 GHz
Finish:	Passivated Stainless Steel

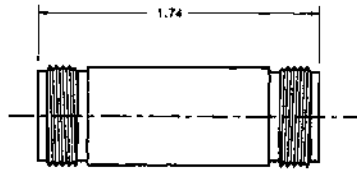

N Male Plug to N Male Plug

Part No.

ADT-2589-MM-NNN-02

Specifications

Frequency:	DC – 18.0 GHz
Impedance:	50 Ohms
VSWR:	1.04 @ DC - 4.0 GHz 1.06 @ 4.0-8.0 GHz 1.10 @ 8.0-18.0 GHz
Finish:	Passivated Stainless Steel

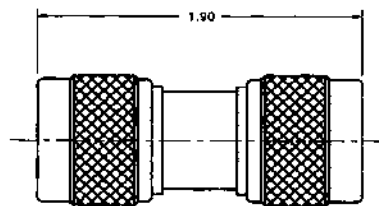

N Female Jack to N Female Jack – Flange Moun

Part No.

ADT-2825-FF-NNN-02

Specifications

Frequency:	DC – 18.0 GHz
Impedance:	50 Ohms
VSWR:	1.04 @ DC - 4.0 GHz 1.06 @ 4.0-8.0 GHz 1.10 @ 8.0-18.0 GHz
Finish:	Passivated Stainless Steel

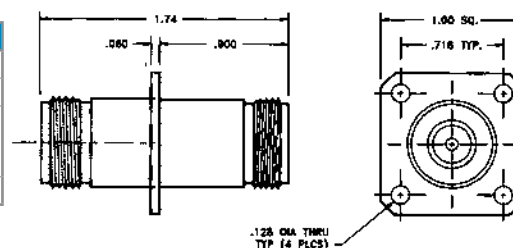

TNC Types

TNC Male Plug to TNC Female Jack

Part No.

ADT-2596-MF-TNC-02

Specifications

Frequency:	DC – 18.0 GHz
Impedance:	50 Ohms
VSWR:	1.05 @ DC - 4.0 GHz
	1.10 @ 4.0-8.0 GHz
	1.15 @ 8.0-18.0 GHz
Finish:	Passivated Stainless Steel

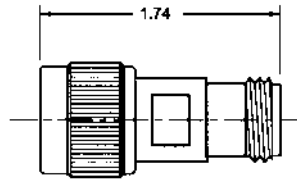

TNC Female Jack to TNC Female Jack

Part No.

ADT-2598-FF-TNC-02

Specifications

Frequency:	DC – 18.0 GHz
Impedance:	50 Ohms
VSWR:	1.05 @ DC - 4.0 GHz
	1.10 @ 4.0-8.0 GHz
	1.15 @ 8.0-18.0 GHz
Finish:	Passivated Stainless Steel

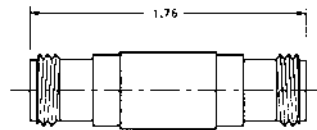

TNC Male Plug to TNC Male Plug

Part No.

ADT-2597-MM-TNC-02

Specifications

Frequency:	DC – 18.0 GHz
Impedance:	50 Ohms
VSWR:	1.05 @ DC - 4.0 GHz
	1.10 @ 4.0-8.0 GHz
	1.15 @ 8.0-18.0 GHz
Finish:	Passivated Stainless Steel

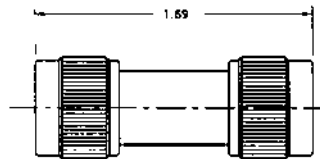

TNC Female Jack to TNC Female Jack – Flange Mount

Part No.

ADT-2826-FF-TNC-02

Specifications

Frequency:	DC – 18.0 GHz
Impedance:	50 Ohms
VSWR:	1.05 @ DC - 4.0 GHz
	1.10 @ 4.0-8.0 GHz
	1.15 @ 8.0-18.0 GHz
Finish:	Passivated Stainless Steel

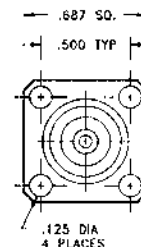
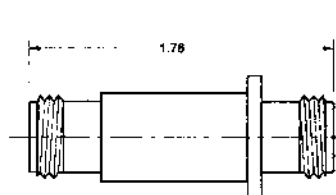

BNC Male Plug to BNC Female Jack

Part No.	
ADT-2828-MF-BNC-10	

Specifications	
Frequency:	DC – 4.0 GHz
Impedance:	50 Ohms
VSWR:	1.25
Finish:	Nickel Plated Brass

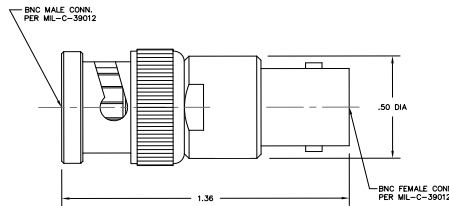

BNC Female Jack to BNC Female Jack

Part No.	
ADT-2829-FF-BNC-10	

Specifications	
Frequency:	DC – 4.0 GHz
Impedance:	50 Ohms
VSWR:	1.25
Finish:	Nickel Plated Brass

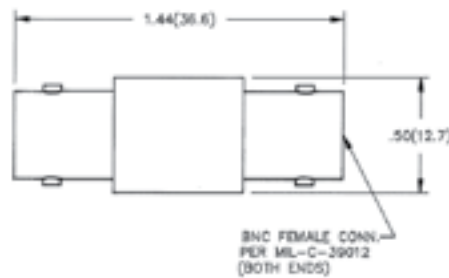

BNC Male Plug to BNC Male Plug

Part No.	
ADT-2830-MM-BNC-10	

Specifications	
Frequency:	DC – 4.0 GHz
Impedance:	50 Ohms
VSWR:	1.25
Finish:	Nickel Plated Brass

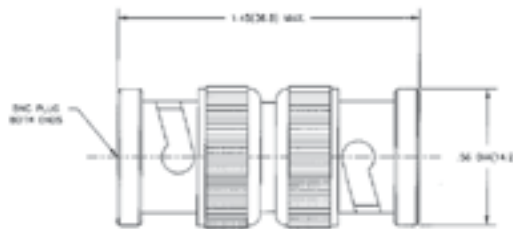

BNC Female Jack to BNC Female Jack – Blkhd Mount

Part No.	
ADT-2831-FF-BNC-10	

Specifications	
Frequency:	DC – 4.0 GHz
Impedance:	50 Ohms
VSWR:	1.25
Finish:	Nickel Plated Brass

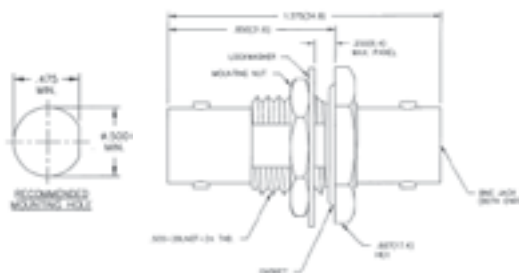

SC Types

SC Male Plug to SC Female Jack

Part No.

ADT-2832-MF-SC0-02

Specifications

Frequency:	DC – 11.0 GHz
Impedance:	50 Ohms
VSWR:	1.08 @ DC - 4.0 GHz 1.20 @ 4.0-11.0 GHz
Finish:	Passivated Stainless Steel

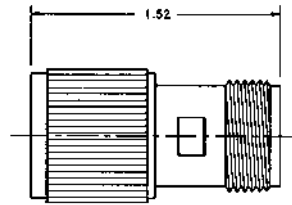

SC Female Jack to SC Female Jack

Part No.

ADT-2833-FF-SC0-02

Specifications

Frequency:	DC – 11.0 GHz
Impedance:	50 Ohms
VSWR:	1.08 @ DC - 4.0 GHz 1.20 @ 4.0-11.0 GHz
Finish:	Passivated Stainless Steel

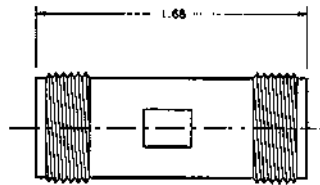

SC Male Plug to SC Male Plug

Part No.

ADT-2834-MM-SC0-02

Specifications

Frequency:	DC – 11.0 GHz
Impedance:	50 Ohms
VSWR:	1.08 @ DC - 4.0 GHz 1.20 @ 4.0-11.0 GHz
Finish:	Passivated Stainless Steel

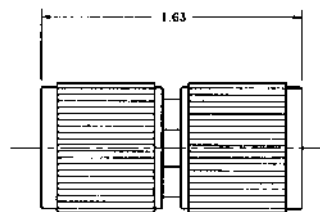

SC Female Jack to SC Female Jack – Flange Mount

Part No.

ADT-2835-FF-SC0-02

Specifications

Frequency:	DC – 11.0 GHz
Impedance:	50 Ohms
VSWR:	1.08 @ DC - 4.0 GHz 1.20 @ 4.0-11.0 GHz
Finish:	Passivated Stainless Steel

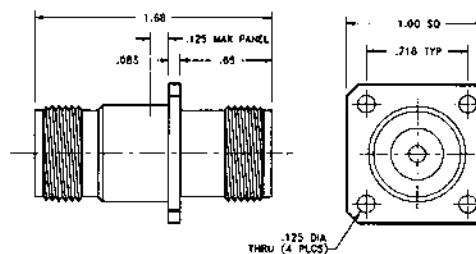

Note: Also available in bulkhead mount as ADT-2836-FF-SC0-02.

HN Male Plug to HN Female Jack

Part No.

ADT-2820-MF-HN0-02

Specifications

Frequency:	DC – 8.0 GHz
Impedance:	50 Ohms
VSWR:	1.08 @ DC - 4.0 GHz 1.20 @ 4.0-8.0 GHz
Finish:	Passivated Stainless Steel

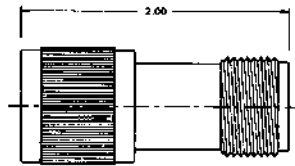

HN Female Jack to HN Female Jack

Part No.

ADT-2821-FF-HN0-02

Specifications

Frequency:	DC – 8.0 GHz
Impedance:	50 Ohms
VSWR:	1.08 @ DC - 4.0 GHz 1.20 @ 4.0-8.0 GHz
Finish:	Passivated Stainless Steel

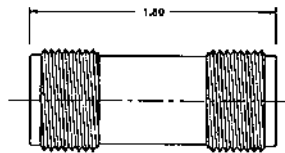

HN Male Plug to HN Male Plug

Part No.

ADT-2744-MM-HN0-02

Specifications

Frequency:	DC – 8.0 GHz
Impedance:	50 Ohms
VSWR:	1.08 @ DC - 4.0 GHz 1.20 @ 4.0-8.0 GHz
Finish:	Passivated Stainless Steel

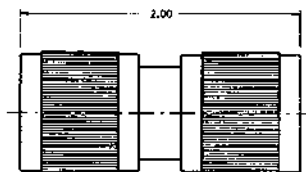

HN Female Jack to HN Female Jack – Flange Mount

Part No.

ADT-2822-FF-HN0-02

Specifications

Frequency:	DC – 8.0 GHz
Impedance:	50 Ohms
VSWR:	1.08 @ DC - 4.0 GHz 1.20 @ 4.0-8.0 GHz
Finish:	Passivated Stainless Steel

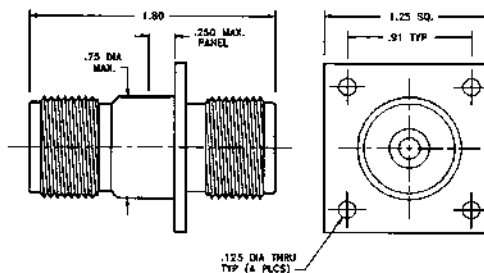

Special Adapters

N Male Plug to N Female Jack – Flange Mount

Part No.

ADT-2694-MF-NNN-02

Specifications

Frequency:	DC – 18.0 GHz
Impedance:	50 Ohms
VSWR:	1.05 @ DC - 4.0 GHz 1.06 @ 4.0-8.0 GHz 1.10 @ 8.0-18.0 GHz
Finish:	Passivated Stainless Steel

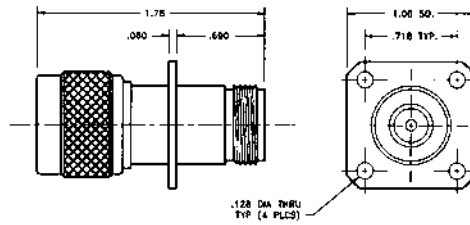

Flange Mount 7mm to 7mm

Part No.

ADT-2667-00-7MM-02

Specifications

Frequency:	DC – 18.0 GHz
Impedance:	50 Ohms
VSWR:	1.025 + .0025 f (GHz)
Finish:	Passivated Stainless Steel

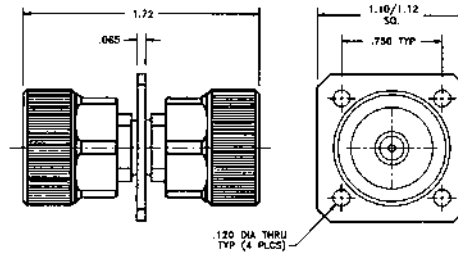

TNC Female Jack to SMA Female Jack – Rear Mount Bulkhead

Part No.

ADT-2837-TF-SMF-02

Specifications

Frequency:	DC – 18.0 GHz
Impedance:	50 Ohms
VSWR:	1.10 @ DC - 4.0 GHz 1.15 @ 4.0-8.0 GHz 1.25 @ 8.0-18.0 GHz
Finish:	Passivated Stainless Steel

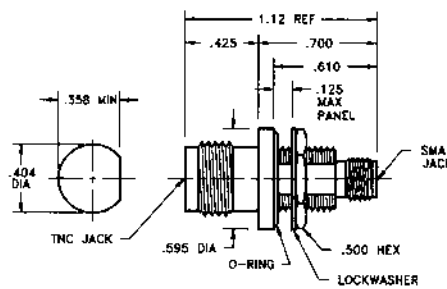

BNC Female Jack to SMA Female Jack – Rear Mount Bulkhead

Part No.

ADT-2838-BF-SMF-02

Specifications

Frequency:	DC – 4.0 GHz
Impedance:	50 Ohms
VSWR:	1.15
Finish:	Passivated Stainless Steel

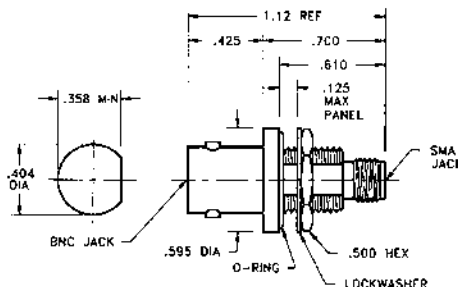

Connectors

General Information.....	128
SMA for Semi-Rigid Cable .085 and .141 / Direct Solder Attachment	129
SMA for Flexible Cable	
Solder Attachment Type.....	131
Crimp Attachment Type	132
SMA Panel Mount Receptacles	
Solder Pot Terminal Type	133
Slotted Terminal Type.....	138
Tab Terminal Type	139-140
SMA Bulkhead Mount Receptacles	
Solder Pot Terminal Type	135
Straight Terminal Type	136
Terminal Type & Printed Circuit Type	137
Tab Terminal Type	139
SMA Field Replaceable Launchers / Drop-in Hermetic Seals.....	141-143
Recommended Mounting Hole Detail/ For Field Replaceable Hermetic Launchers.....	144
Hermetically Sealed Receptacles	
Jack	145
Plug	146
SSMA for Semi-Rigid Cable / .085 Direct Solder Attachment	147
SSMA Subminiature Type / Crimp Attachment for Flexible Cable.....	148
SSMA Panel Mount Receptacles	
Solder Pot Terminal Type	149
Terminal, Tab & Printed Circuit Types.....	150
SMM Microminiature Connectors / For Flexible and Semi-Rigid Cables	151
SSMA Microminiature Receptacles / Panel • Bulkhead • Printed Circuit.....	152
BMA Blind Mate Connectors.....	153
BMA – Blind Mate Connectors / Rigid and Float Mount Applications.....	154
BMA for Semi-Rigid Cables / .085 and .141 Direct Solder Attachment	155
BMA for Flexible Cable / Crimp Attachment Type	156
BMA Blind Mate Receptacles	
Straight Terminal Panel Mount Type	157
Threaded and Press Fit Type	158
Printed Circuit Mount Type.....	159
Stripline and Drop-In Hermetic Types.....	160
Precision Connectors 3.5mm	161
Precision Connectors 2.9mm	162
Precision Connectors 7mm	163-164
Type N for Semi-Rigid Cable / .085 and .141 Direct Solder Attachment	165, 169
Type N for Flexible Cable	
Crimp Attachment Type	166
Panel Bulkhead Reception	167-168
TNC for Flexible Cable / Crimp Attachment Type	170
TNC / Panel and Bulkhead Receptacles	171
Type N / Panel and Bulkhead Receptacles	172
BNC for Semi-Rigid Cable / .085 and .141 Direct Solder Attachment	173
BNC for Flexible Cable / Crimp Attachment Type	174
BNC / Panel and Bulkhead Receptacles	175

3 Attenuators

31 Terminations

58 DC Blocks

61 Couplers

73 Power Dividers

81 Equalizers

85 Phase Shifters

87 Between Series Adapters

116 In-Series Adapters

127 Connectors

177 QPL Approved Products & Tools for Assembly

200 Appendix

209 Index

While every precaution has been taken to ensure accuracy and completeness herein, Emerson Network Power Connectivity Solutions assumes no responsibility, and disclaims all liability for damages resulting from use of this information or for any errors or omissions. Specifications subject to change without notice.

General Information

- MIL-PRF-39012 Qualified (QPL)
- SMA, BMA, N, TNC, BNC, 3.5mm, 7mm Interfaces
- Semi-Rigid and Flexible Cable Accommodation
- Panel, Bulkhead, and Printed Circuit Mounts

Midwest Microwave offers this complete product line of coaxial connectors that include most all of the popular interfaces. They are constructed using rugged stainless steel for the ultimate in wear resistant reliability and conform to the requirements of MIL-PRF-39012 with the SMA series listed on the Qualified Parts List (QPL). The selection of catalog standard items is broad and provides the flexibility for custom engineered designs to meet unique system requirements. Connectors for semi-rigid and flexible cable in a wide variety of configurations are offered as well as a complete assortment of panel and bulkhead mounted receptacles. SMA, SSMA, SMM, BMA, N, TNC, BNC, SC, and precision 2.9mm, 3.5mm, and 7mm connectors provide a full spectrum of interface types. In addition, field replaceable hermetic launchers with drop-in hermetic seals are available to fulfill the growing requirement for field replaceable connectors on integrated microwave circuit packages.

General Specifications

Specification Requirement	MIL-C-39012 Paragraph	Detail Information																																																								
General																																																										
Material	3.3	Stainless Steel, corrosion resistant per ASTM-A-582 and ASTM-A-484, Type 303. Brass, half hard per ASTM-B16. Beryllium Copper per ASTM-B196. PTFE Fluorocarbon per ASTM-D-4894, and ASTM-D-4895.																																																								
Finish	3.31	Center contacts shall be gold plated to a minimum thickness of 50 micro inches per ASTM B 488, type II, code C. All other metal parts shall be finished so as to provide the required protection to meet the corrosion specification requirements.																																																								
Design	3.40	The design of the connectors herein shall be such that the outline drawings shown in this catalog and the coaxial interface mating dimensions shown in the Appendix meet the requirements of MIL-STD-348.																																																								
Electrical																																																										
Insulation Resistance	3.11	Insulation Resistance shall not be less than 5,000 megohms.																																																								
Corona Level	3.22	Refer to the applicable military slash sheet or consult factory if one does not exist.																																																								
Dielectric Withstanding Voltage	3.17	Refer to the applicable military slash sheet or consult factory if one does not exist.																																																								
RF High Potential	3.23	Refer to the applicable military slash sheet or consult factory if one does not exist.																																																								
Contact Resistance	3.16	Refer to the applicable military slash sheet or consult factory if one does not exist.																																																								
VSWR	3.14	Refer to the applicable military slash sheet or consult factory if one does not exist. VSWR and Frequency Range is dependent on the type and size cable used.																																																								
RF Leakage	3.26	Refer to the applicable military slash sheet or consult factory if one does not exist.																																																								
Insertion Loss	3.27	Refer to the applicable military slash sheet or consult factory if one does not exist. Insertion Loss is dependent on the type and size cable used.																																																								
Mechanical																																																										
Force to Engage	3.5.1	Torque required to engage and disengage shall not exceed: SMA - 2 in-lbs SMM - 1 in-lbs N&SC - 6 in-lbs TNC - 2 in-lbs BNC - 2.5 in-lbs Longitudinal Force not applicable except for BNC = 3 lbs max. BMA - Engage = 3 lbs max. Disengage = 1.5 lbs max																																																								
Coupling Nut Retention	3.25	SMA - 60 lbs min. SSM - 40 lbs min. N, TNC, BNC, & SC - 100 lbs min.																																																								
Coupling Proof Torque (min.)	3.60	SMA - 15 in-lbs SSM - 4 in-lbs N - 30 in-lbs TNC & SC - 15 in-lbs																																																								
Cable Retention	3.24	Refer to the applicable military slash sheet or consult factory if one does not exist.																																																								
Mating Characteristics	3.70																																																									
Connector Durability	3.15	<table border="1"> <thead> <tr> <th></th> <th>SMA</th> <th>SSM</th> <th>BMA</th> <th>N</th> <th>TNC</th> <th>BNC</th> <th>SC</th> </tr> </thead> <tbody> <tr> <td>Oversize Test Pin min.:</td> <td>.0375</td> <td>.0165</td> <td>.0372</td> <td>.067</td> <td>.055</td> <td>.055</td> <td>.093</td> </tr> <tr> <td>Insertion Depth:</td> <td>.045</td> <td>.045</td> <td>.045</td> <td>.125</td> <td>.125</td> <td>.125</td> <td>.125</td> </tr> <tr> <td>Insertion Force max.:</td> <td>2 lbs</td> <td>2 lbs</td> <td>2 lbs</td> <td>2 lbs</td> <td>2 lbs</td> <td>2 lbs</td> <td>2 lbs</td> </tr> <tr> <td>Insertion Pin Dia min.:</td> <td>.0370</td> <td>.0163</td> <td>.0370</td> <td>.0658</td> <td>.054</td> <td>.054</td> <td>.092</td> </tr> <tr> <td>Withdrawal Force min.:</td> <td>1 oz.</td> <td>.5 oz.</td> <td>1 oz.</td> <td>2 oz.</td> <td>2 oz.</td> <td>1 oz.</td> <td>2 oz.</td> </tr> <tr> <td>Withdrawal Pin Dia max.:</td> <td>.0355</td> <td>.015</td> <td>.0355</td> <td>.0645</td> <td>.052</td> <td>.052</td> <td>.090</td> </tr> </tbody> </table>		SMA	SSM	BMA	N	TNC	BNC	SC	Oversize Test Pin min.:	.0375	.0165	.0372	.067	.055	.055	.093	Insertion Depth:	.045	.045	.045	.125	.125	.125	.125	Insertion Force max.:	2 lbs	2 lbs	2 lbs	2 lbs	2 lbs	2 lbs	2 lbs	Insertion Pin Dia min.:	.0370	.0163	.0370	.0658	.054	.054	.092	Withdrawal Force min.:	1 oz.	.5 oz.	1 oz.	2 oz.	2 oz.	1 oz.	2 oz.	Withdrawal Pin Dia max.:	.0355	.015	.0355	.0645	.052	.052	.090
	SMA	SSM	BMA	N	TNC	BNC	SC																																																			
Oversize Test Pin min.:	.0375	.0165	.0372	.067	.055	.055	.093																																																			
Insertion Depth:	.045	.045	.045	.125	.125	.125	.125																																																			
Insertion Force max.:	2 lbs	2 lbs	2 lbs	2 lbs	2 lbs	2 lbs	2 lbs																																																			
Insertion Pin Dia min.:	.0370	.0163	.0370	.0658	.054	.054	.092																																																			
Withdrawal Force min.:	1 oz.	.5 oz.	1 oz.	2 oz.	2 oz.	1 oz.	2 oz.																																																			
Withdrawal Pin Dia max.:	.0355	.015	.0355	.0645	.052	.052	.090																																																			
Recommended Mating Torque	-	SMA - 7-10 in-lbs SSM - 2 in-lbs N, TNC, & SC - 12-15 in-lbs BNC&BMA - N/A																																																								
Environmental																																																										
Vibration	3.18	Per Specification MIL-STD-202, method 204, test condition D																																																								
Shock	3.19	Per Specification MIL-STD-202, method 213, test condition I																																																								
Thermal Shock	3.20	Refer to the applicable military slash sheet or consult factory if one does not exist.																																																								
Corrosion (Salt Spray)	3.13	Per Specification MIL-STD-202, method 101, test condition B																																																								
Moisture Resistance	3.21	Per Specification MIL-STD-202, method 106, no measurements at high humidity. Insulation resistance shall be 200 megohms minimum within 5 minutes of humidity.																																																								

Straight Male Cable Plug – Without Center Contact

Part No.	Cable Dia.
SMA-0141-92-000-02	.141 (RG402)

Note: Standard finish is passivated stainless steel.
Please contact customer service for availability of gold-plated version.

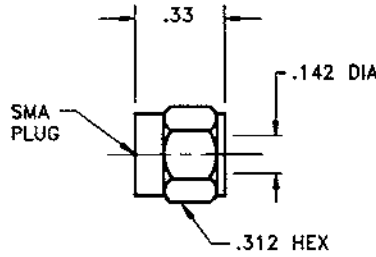

Straight Male Cable Plug – With Separate Solder Center Contact

Part No.	Cable Dia.
SMA-0141-79-000-02	.141 (RG402)
SMA-0085-79-000-02	.085 (RG405)

Note: Standard finish is passivated stainless steel.
Please contact customer service for availability of gold-plated version.

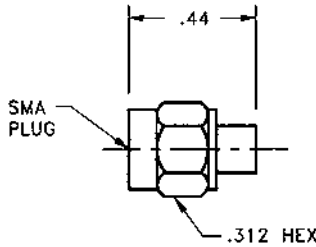

Straight Male Cable Plug – With Separate Captured Spring Center Contact

Part No.	Cable Dia.
SMA-4141-89-000-02	.141 (RG402)
SMA-4085-89-000-02	.085 (RG405)

Note: Standard finish is passivated stainless steel.
Please contact customer service for availability of gold-plated version.

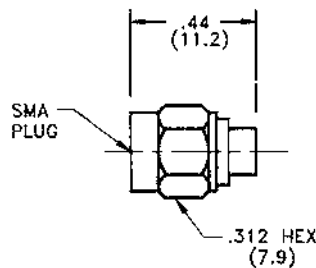

Straight Male Cable Plug – With Retractable Coupling Nut & Captured Spring Center Contact

Part No.	Cable Dia.
SMA-5141-89-000-02	.141 (RG402)
SMA-5085-89-000-02	.085 (RG405)

Note: Also available with solder type center contact as SMA-5141-79-000-02 and SMA-5085-79-000-02. Detail interface dimensions and RG/U cable information can be found in the appendix.

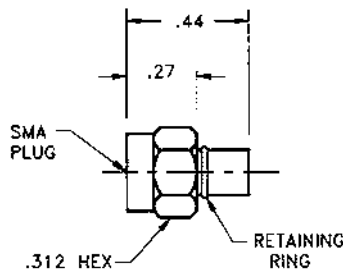

SMA for Semi-Rigid Cable .085 and .141 / Direct Solder Attachment

Straight Female Cable Jack

Part No.	Cable Dia.
SMA-0141-81-000-00	.141 (RG402)
SMA-0085-81-000-00	.085 (RG405)

Note: Also available with spring type center contact as SMA-4141-82-000-02 and SMA-4085-82-000-02. Standard finish is gold plating for direct soldering to semi-rigid cable.

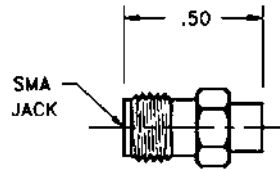

Straight Bulkhead Female Cable Jack

Part No.	Cable Dia.
SMA-0141-83-000-00	.141 (RG402)
SMA-0085-83-000-00	.085 (RG405)

Note: Also available with spring type center contact as SMA-4141-83-000-02 and SMA-4085-83-000-020.

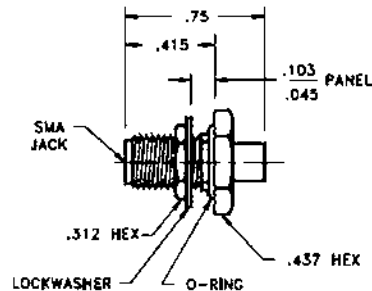

Straight Panel Mount Female Cable Jack – 2 Hole and 4 Hole

Part No.	Cable Dia.
SMA-0141-84-4HL-00	.141 (RG402)
SMA-0085-84-4HL-00	.085 (RG405)
SMA-0141-82-2HL-00	.141 (RG402)
SMA-0085-82-2HL-00	.085 (RG405)

Note: Also available with spring type center contact as SMA-4141-84-4HL-02 and SMA-4085-82-4HL-0 for 4 hole type and as SMA-4141-84-2HL and SMA-4085-82-2HL-02 for two hole type.

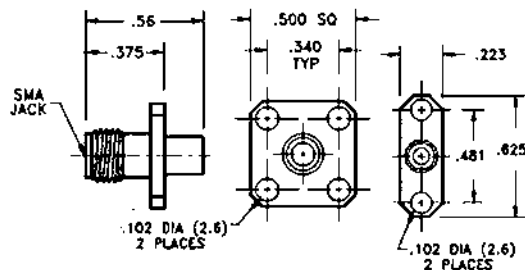

Right Angle Male Cable Plug

Part No.	Cable Dia.
SMA-0141-80-000-02	.141 (RG402)
SMA-0085-80-000-02	.085 (RG405)

Note: Standard finish is passivated stainless steel. Please contact customer service for availability of gold-plated version.

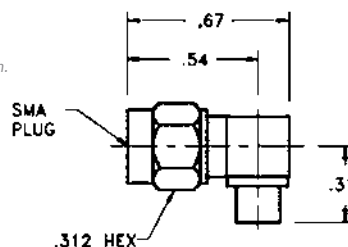

Straight Male Cable Plug

Part No.	Cable Type (RG/U)	Dim A
SMA-0142-55-000-02	55; 58; 141; 142; 223; 303; 400	.775 (19.7)
SMA-0188-55-000-02	174; 179; 188; 316	.690 (17.5)

Note: Standard finish is passivated stainless steel.

Please contact customer service for availability of gold-plated version.

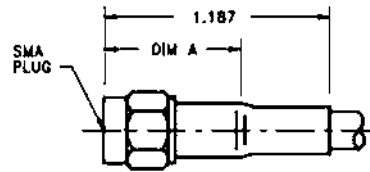

Straight Bulkhead Feedthru Female Cable Jack

Part No.	Cable Type (RG/U)	Dim A
SMA-0142-59-000-00	55; 58; 141; 142; 223; 303; 400	.945 (24.0)
SMA-0188-59-000-00	174; 179; 188; 316	.825 (21.0)

Note: Standard finish is gold plate.

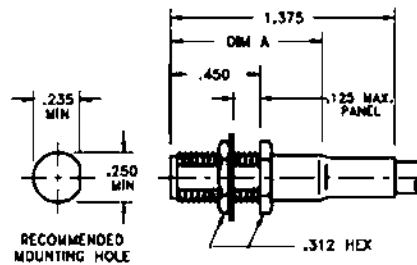

Straight Panel Mount Female Cable Jack – 4 Hole and 2 Hole

Part No.	Cable Type (RG/U)	Dim A
SMA-0142-54-4HL-00	55; 58; 141; 142; 223; 303; 400	.870 (19.7)
SMA-0188-54-4HL-00	174; 179; 188; 316	.825 (17.5)
SMA-0142-58-2HL-00	55; 58; 141; 142; 223; 303; 400	.870 (19.7)
SMA-0188-58-2HL-00	174; 179; 188; 316	.825 (17.5)

Note: Standard finish is gold plated.

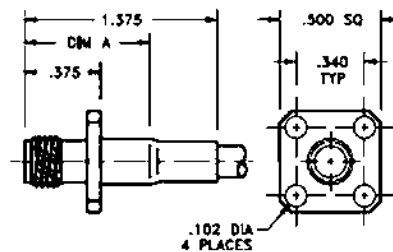

Right Angle Male Cable Plug

Part No.	Cable Type (RG/U)	Dim A
SMA-0142-56-000-02	55; 58; 141; 142; 223; 303; 400	.630 (16.0)
SMA-0188-56-000-02	174; 179; 188; 316	.440 (11.2)

Note: Standard finish is passivated stainless steel.

Please contact customer service for availability of gold-plated version.

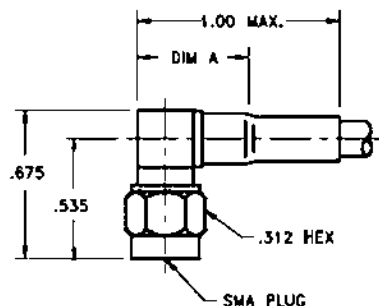

SMA for Flexible Cable / Crimp Attachment Type

Straight Male Cable Plug

Part No.	Cable Type (RG/U)
SMA-1055-55-000-02	55; 142; 223; 400
SMA-1058-55-000-02	58; 141; 303
SMA-1188-55-000-02	174; 179; 188; 316

Note: Standard finish is passivated stainless steel.

Please contact customer service for availability of gold-plated version.

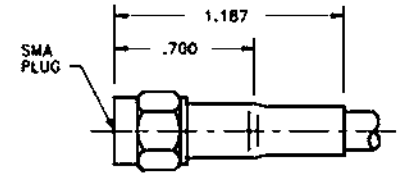

Straight Bulkhead Feedthru Female Cable Jack

Part No.	Cable Type (RG/U)
SMA-1055-59-000-02	55; 142; 223; 400
SMA-1058-59-000-02	58; 141; 303
SMA-1188-59-000-02	174; 179; 188; 316

Note: Also available with spring type center contact as SMA-4141-83-000-02 and SMA-4085-83-000-020.

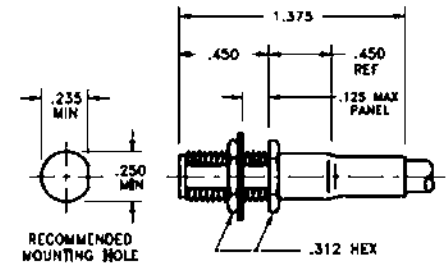

Straight Panel Mount Female Cable Jack – 4 Hole and 2 Hole

Part No.	Cable Type (RG/U)
SMA-1055-54-4HL-02	55; 142; 223; 400
SMA-1058-54-4HL-02	58; 141; 303
SMA-1188-54-4HL-02	174; 179; 188; 316
SMA-1055-58-2HL-02	55; 142; 223; 400
SMA-1058-58-2HL-02	58; 141; 303
SMA-1188-58-2HL-02	174; 179; 188; 316

Note: Standard finish is passivated stainless steel.

Please contact customer service for availability of gold-plated version.

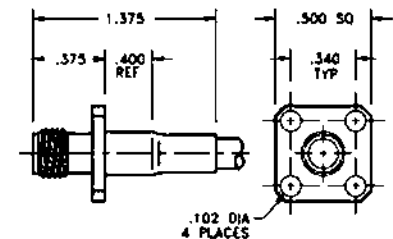

Right Angle Male Cable Plug

Part No.	Cable Type (RG/U)
SMA-1055-56-000-02	55; 142; 223; 400
SMA-1058-56-000-02	58; 141; 303
SMA-1188-56-000-02	174; 179; 188; 316

Note: Standard finish is passivated stainless steel.

Please contact customer service for availability of gold-plated version.

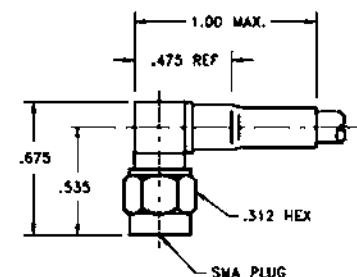

Straight Flange Mount Female Jack Receptacle – 4 Hole

Part No.

SMA-5540-15-POT-02

Note: Standard finish is passivated stainless steel.
Please contact customer service for availability of gold-plated version.

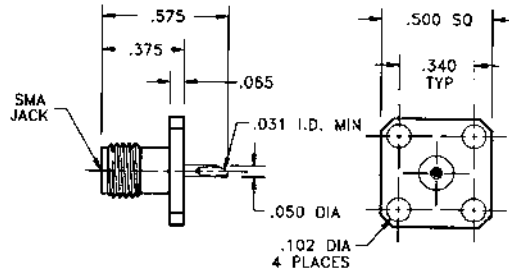

Straight Flange Mount Female Jack Receptacle – 2 Hole

Part No.

SMA-5240-15-POT-02

Note: Standard finish is passivated stainless steel.
Please contact customer service for availability of gold-plated version.

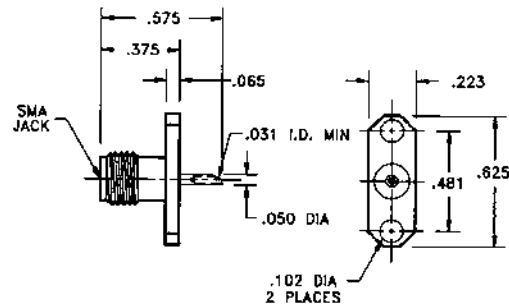

Straight Flange Mount Female Jack Receptacle – .687 Sq. Flange

Part No.

SMA-5640-15-POT-02

Note: Standard finish is passivated stainless steel.
Please contact customer service for availability of gold-plated version. Also available in 1 inch square flange size as SMA-5140-15-POT-02.

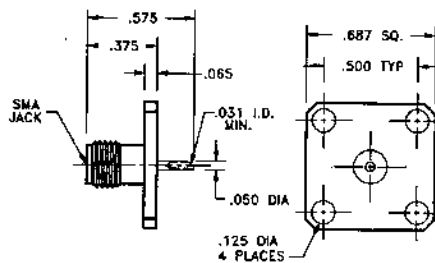

Right Angle Flange Mount Female Jack Receptacle

Part No.

SMA-5540-16-POT-02

Note: Standard finish is passivated stainless steel.
Please contact customer service for availability of gold-plated version.

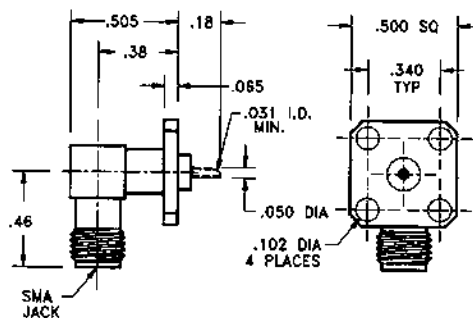

SMA Panel Mount Receptacles / Solder Pot Terminal Type

Straight Flange Mount Male Plug Receptacle – 4 Hole

Part No.

SMA-5540-14-POT-02

Note: Standard finish is passivated stainless steel.
Please contact customer service for availability of gold-plated version.

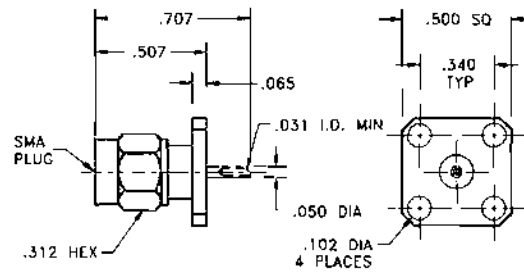

Straight Flange Mount Male Plug Receptacle – 2 Hole

Part No.

SMA-5240-14-POT-02

Note: Standard finish is passivated stainless steel.
Please contact customer service for availability of gold-plated version.

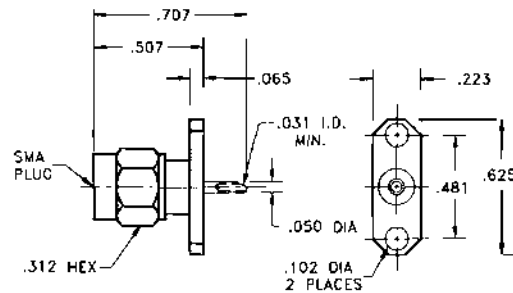

Straight Flange Mount Male Plug Receptacle – .687 Sq. Flange

Part No.

SMA-5640-14-POT-02

Note: Standard finish is passivated stainless steel.
Please contact customer service for availability of gold-plated version. Also available in 1 inch square flange size as SMA-5140-15-POT-02.

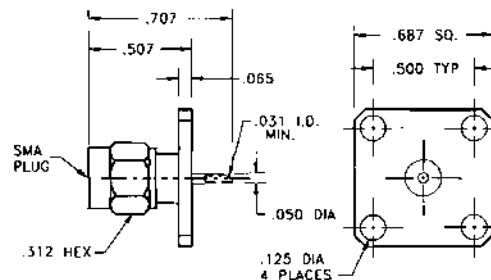

Right Angle Flange Mount Male Plug Receptacle

Part No.

SMA-5540-17-POT-02

Note: Standard finish is passivated stainless steel.
Please contact customer service for availability of gold-plated version.

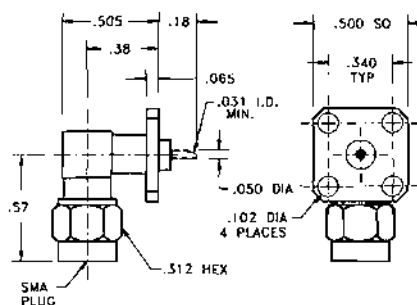

Straight Bulkhead Feedthru Female Jack Receptacle – Adjustable

Part No.

SMA-5940-12-POT-02

Note: Standard finish is passivated stainless steel.
Please contact customer service for availability of gold-plated version.

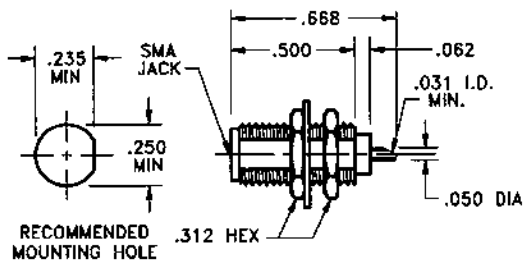

Straight Bulkhead Feedthru Female Jack Receptacle – Rear Mount

Part No.

SMA-5040-11-POT-02

Note: Standard finish is passivated stainless steel.
Please contact customer service for availability of gold-plated version.

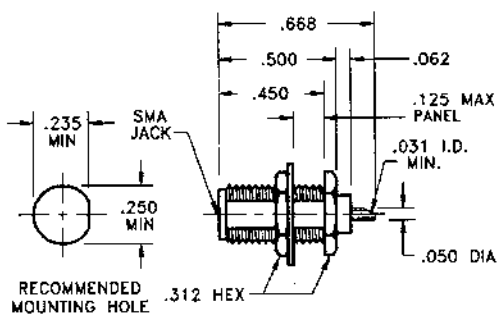

Straight Bulkhead Mount Female Jack Receptacle – Gasket Seal

Part No.

SMA-5040-18-POT-02

Note: Standard finish is passivated stainless steel.
Please contact customer service for availability of gold-plated version.

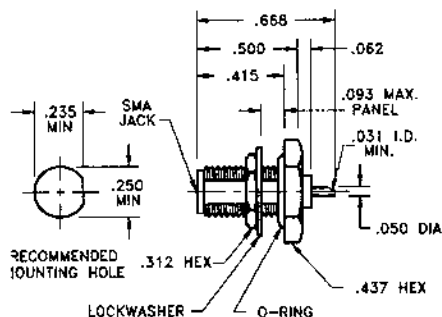

Straight Bulkhead Mount Female Jack Receptacle – Front Mount

Part No.

SMA-5040-12-POT-02

Note: Standard finish is passivated stainless steel.
Please contact customer service for availability of gold-plated version.

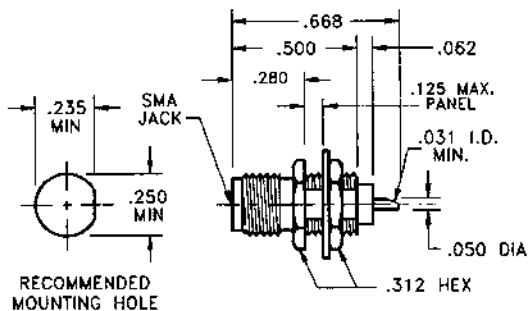

SMA Bulkhead Mount Receptacles / Straight Terminal Type

Straight Flange Mount Female Jack Receptacle – 4 Hole

Part No.

SMA-5510-15-TRM-02

Note: Standard finish is passivated stainless steel.
Please contact customer service for availability
of gold-plated version.

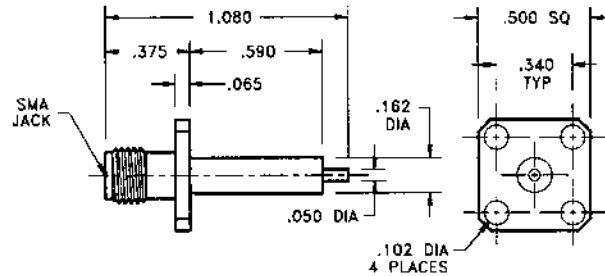

Straight Flange Mount Female Jack Receptacle – 2 Hole

Part No.

SMA-5210-15-TRM-02

Note: Standard finish is passivated stainless steel.
Please contact customer service for availability
of gold-plated version.

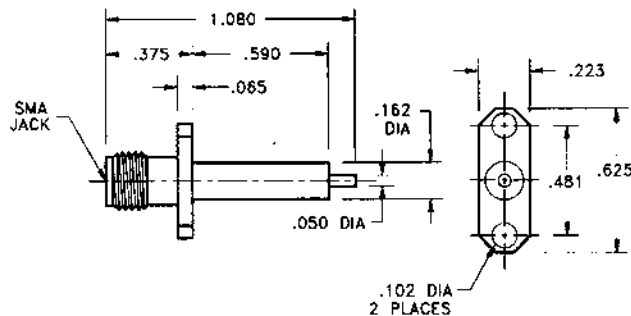

Straight Flange Mount Male Plug Receptacle – 4 Hole

Part No.

SMA-5510-14-TRM-02

Note: Standard finish is passivated stainless steel.
Please contact customer service for availability
of gold-plated version.

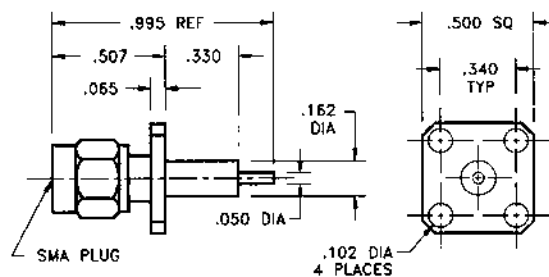

Straight Flange Mount Male Plug Receptacle – 2 Hole

Part No.

SMA-5210-14-TRM-02

Note: Standard finish is passivated stainless steel.
Please contact customer service for availability
of gold-plated version.

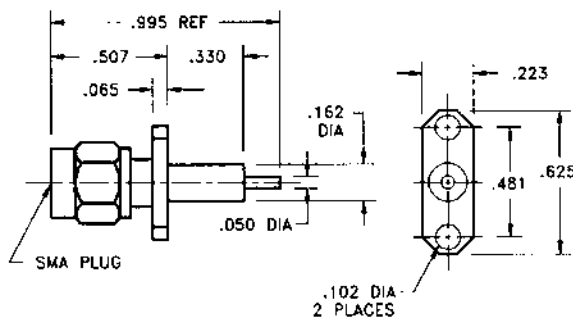

Straight Bulkhead Feedthru Female Jack Receptacle – Adjustable

Part No.
SMA-5910-12-TRM-02

Note: Standard finish is passivated stainless steel.
Please contact customer service for availability of gold-plated version.

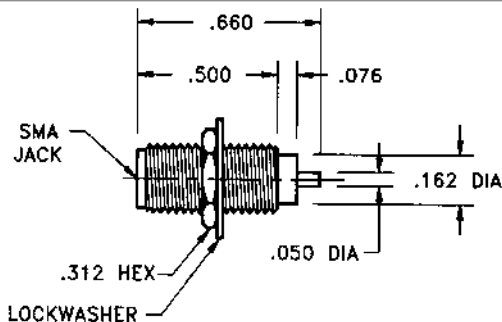

Right Angle Panel Mount Female Jack Receptacle

Part No.
SMA-5510-16-TRM-02

Note: Standard finish is passivated stainless steel.
Please contact customer service for availability of gold-plated version.

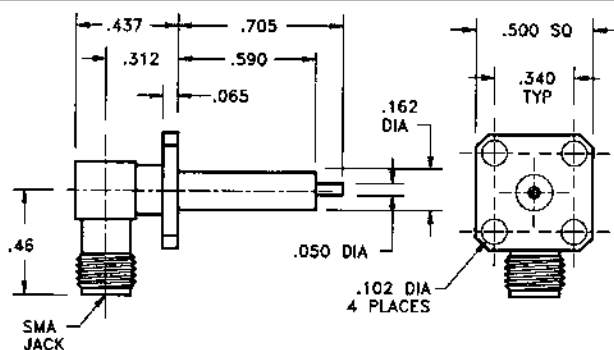

Straight Printed Circuit Board Mount Female Jack Receptacle

Part No.
SMA-5510-93-PCB-00

Note: Standard finish is gold plating for direct soldering to circuit board.

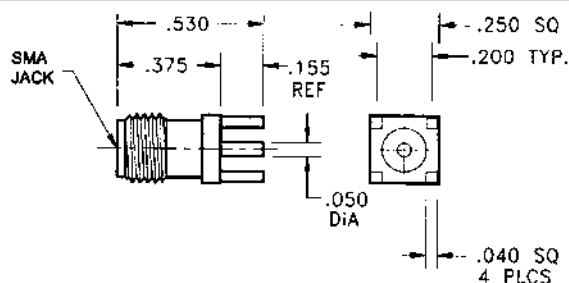

Right Angle Printed Circuit Mount Female Jack Receptacle

Part No.
SMA-5010-94-PCB-00

Note: Standard finish is gold plating for direct soldering to circuit board.
Detail interface dimension information can be found in the appendix.

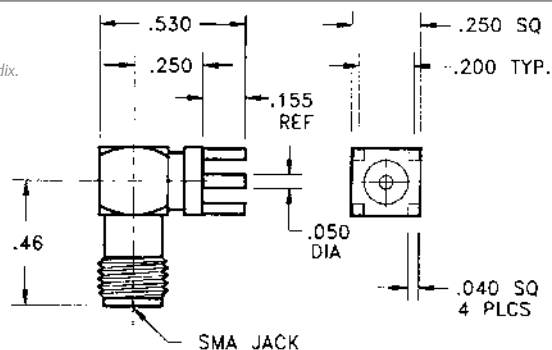

SMA Panel Mount Receptacles / Slotted Terminal Type

Straight Flange Mount Female Jack Receptacle – 4 Hole*

Captured Center Contact**

Part No.	Slot Width inches (mm)	Flange Size square inches (mm)
SMA-5320-15-SLT-02	.012 (0.3)	.375 (9.5)
SMA-5321-15-SLT-02	.018 (0.5)	.375 (9.5)
SMA-5322-15-SLT-02	.028 (0.7)	.375 (9.5)
SMA-5323-15-SLT-02	.036 (0.9)	.375 (9.5)
SMA-5520-15-SLT-02*	.012 (0.3)	500 (12.7) * Two Hole Version is .625 x .223
SMA-5521-15-SLT-02*	.018 (0.5)	500 (12.7) * Two Hole Version is .625 x .223
SMA-5522-15-SLT-02*	.028 (0.7)	500 (12.7) * Two Hole Version is .625 x .223
SMA-5523-15-SLT-02*	.036 (0.9)	500 (12.7) * Two Hole Version is .625 x .223

Part No.	Slot Width inches (mm)	Flange Size square inches (mm)
SMA-5620-15-SLT-02	.012 (0.3)	.687 (17.5)
SMA-5621-15-SLT-02	.018 (0.5)	.687 (17.5)
SMA-5622-15-SLT-02	.028 (0.7)	.687 (17.5)
SMA-5623-15-SLT-02	.036 (0.9)	.687 (17.5)
SMA-5120-15-SLT-02	.012 (0.3)	1.000 (25.4)
SMA-5121-15-SLT-02	.018 (0.5)	1.000 (25.4)
SMA-5122-15-SLT-02	.028 (0.7)	1.000 (25.4)
SMA-5123-15-SLT-02	.036 (0.9)	1.000 (25.4)

Note:

* For two hole version, change the 5th digit of Model No. to "2". Slots are horizontal, for vertical slot, increment 7th digit by 5. Ex: SMA-5225-15-SLT-02.

** For non-captive center contact, change 4th digit of Model No. from "5" to "6". Example: SMA-6320-15-SLT-02.

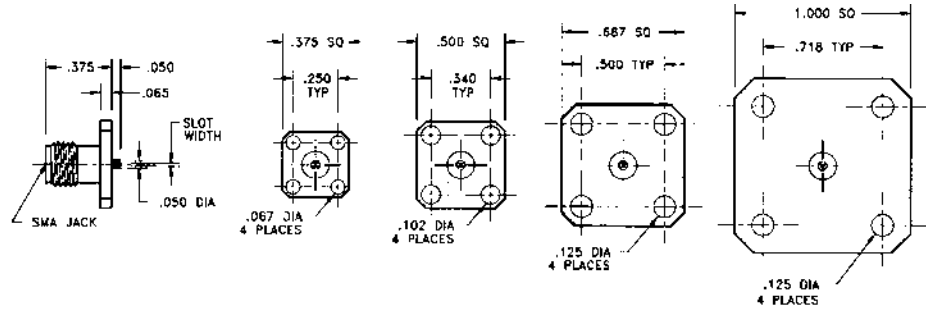

Straight Flange Mount Male Plug Receptacle – 4 Hole*

Captured Center Contact**

Part No.	Slot Width inches (mm)	Flange Size square inches (mm)
SMA-5320-14-SLT-02	.012 (0.3)	.375 (9.5)
SMA-5321-14-SLT-02	.018 (0.5)	.375 (9.5)
SMA-5322-14-SLT-02	.028 (0.7)	.375 (9.5)
SMA-5323-14-SLT-02	.036 (0.9)	.375 (9.5)
SMA-5520-14-SLT-02*	.012 (0.3)	500 (12.7) * Two Hole Version is .625 x .223
SMA-5521-14-SLT-02*	.018 (0.5)	500 (12.7) * Two Hole Version is .625 x .223
SMA-5522-14-SLT-02*	.028 (0.7)	500 (12.7) * Two Hole Version is .625 x .223
SMA-5523-14-SLT-02*	.036 (0.9)	500 (12.7) * Two Hole Version is .625 x .223

Part No.	Slot Width inches (mm)	Flange Size square inches (mm)
SMA-5620-14-SLT-02	.012 (0.3)	.687 (17.5)
SMA-5621-14-SLT-02	.018 (0.5)	.687 (17.5)
SMA-5622-14-SLT-02	.028 (0.7)	.687 (17.5)
SMA-5623-14-SLT-02	.036 (0.9)	.687 (17.5)
SMA-5120-14-SLT-02	.012 (0.3)	1.000 (25.4)
SMA-5121-14-SLT-02	.018 (0.5)	1.000 (25.4)
SMA-5122-14-SLT-02	.028 (0.7)	1.000 (25.4)
SMA-5123-14-SLT-02	.036 (0.9)	1.000 (25.4)

Note:

Standard finish is passivated stainless steel. Please contact customer service for availability of gold-plated version.

* For two hole version, change the 5th digit of Model No. to "2". Slots are horizontal, for vertical slot, increment 7th digit by 5. Ex: SMA-5225-15-SLT-02.

** For non-captive center contact, change 4th digit of Model No. from "5" to "6". Example: SMA-6320-15-SLT-02.

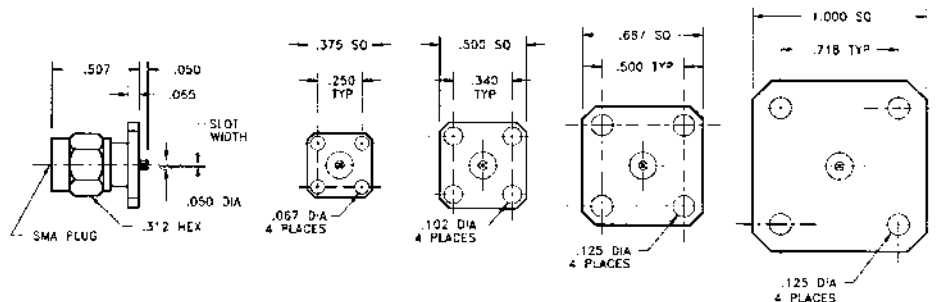

Straight Panel Mount Female Jack Receptacle – 2 Hole

Part No.	Tab Position
SMA-5230-15-TAB-02	Horizontal
SMA-5232-15-TAB-02	Vertical

Note: Standard finish is passivated stainless steel.
Please contact customer service for availability of gold-plated version.

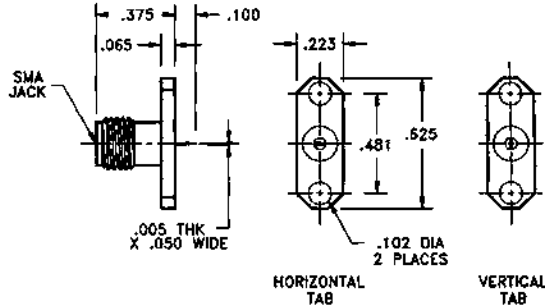

Straight Panel Mount Male Plug Receptacle – 2 Hole

Part No.	Tab Position
SMA-5230-14-TAB-02	Horizontal
SMA-5232-14-TAB-02	Vertical

Note: Standard finish is passivated stainless steel.
Please contact customer service for availability of gold-plated version.

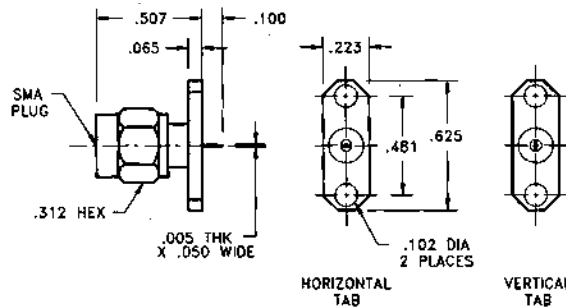

Straight Panel Mount Female Jack Receptacle – Rectangular Flange

Part No.	Tab Position
SMA-5430-15-TAB-02	Horizontal
SMA-5432-15-TAB-02	Vertical

Note: Standard finish is passivated stainless steel.
Please contact customer service for availability of gold-plated version.

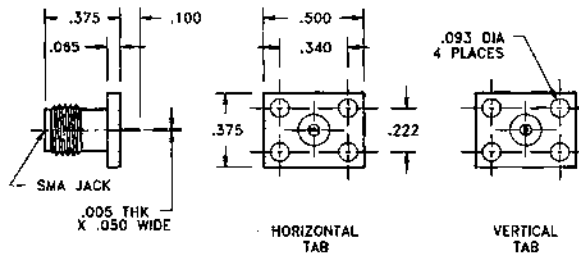

Straight Panel Mount Male Plug Receptacle - Rectangular Flange

Part No.	Tab Position
SMA-5430-14-TAB-02	Horizontal
SMA-5432-14-TAB-02	Vertical

Note: Standard finish is passivated stainless steel.
Please contact customer service for availability of gold-plated version.

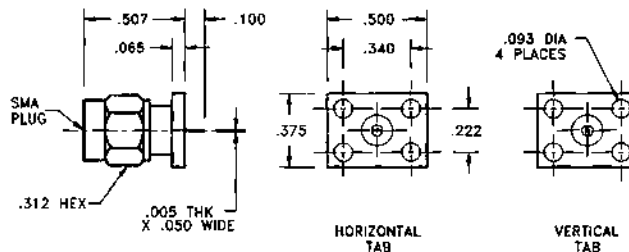

SMA Panel Mount Receptacles / Tab Terminal Type

Straight Flange Mount Female Jack Receptacle – 4 Hole

Captured Center Contact*

Part No.	Flange Size square inches (mm)
SMA-5330-15-TAB-02	.375 (9.5)
SMA-5530-15-TAB-02	.500 (12.7)

Part No.	Flange Size square inches (mm)
SMA-5630-15-TAB-02	.687 (17.5)
SMA-5130-15-TAB-02	1.000 (25.4)

* For non-captive center contact, change fourth digit of Model No. from "5" to "6". Example: SMA-6330-15-TAB-02.

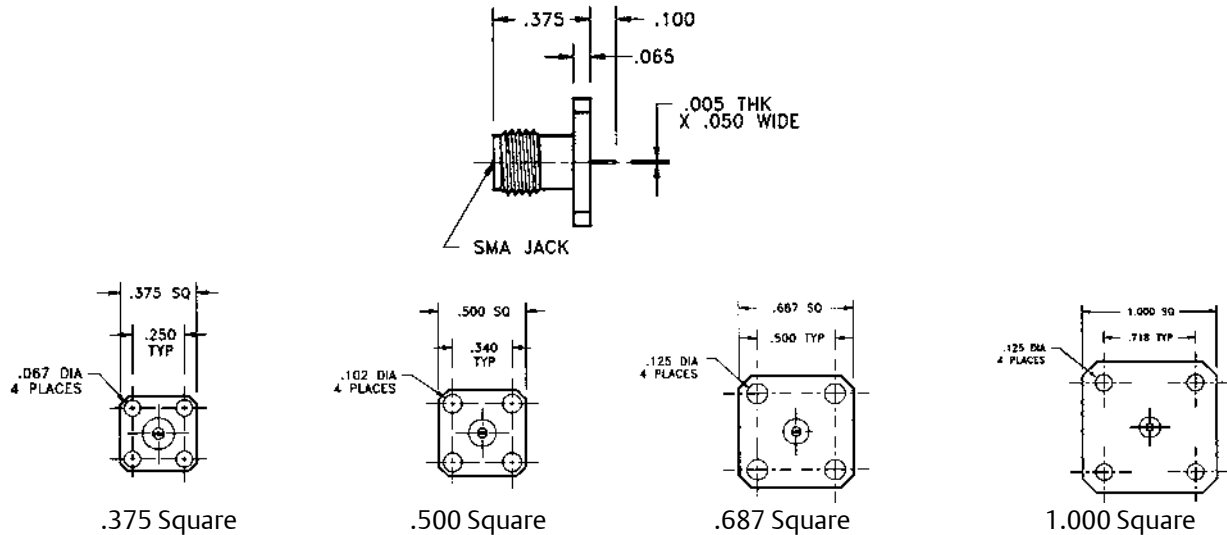

Straight Flange Mount Male Plug Receptacle – 4 Hole

Captured Center Contact*

Part No.	Flange Size square inches (mm)
SMA-5330-14-TAB-02	.375 (9.5)
SMA-5530-14-TAB-02	.500 (12.7)

Part No.	Flange Size square inches (mm)
SMA-5630-14-TAB-02	.687 (17.5)
SMA-5130-14-TAB-02	.687 (17.5)

* For non-captive center contact, change fourth digit of Model No. from "5" to "6". Example: SMA-6330-14-TAB-02.

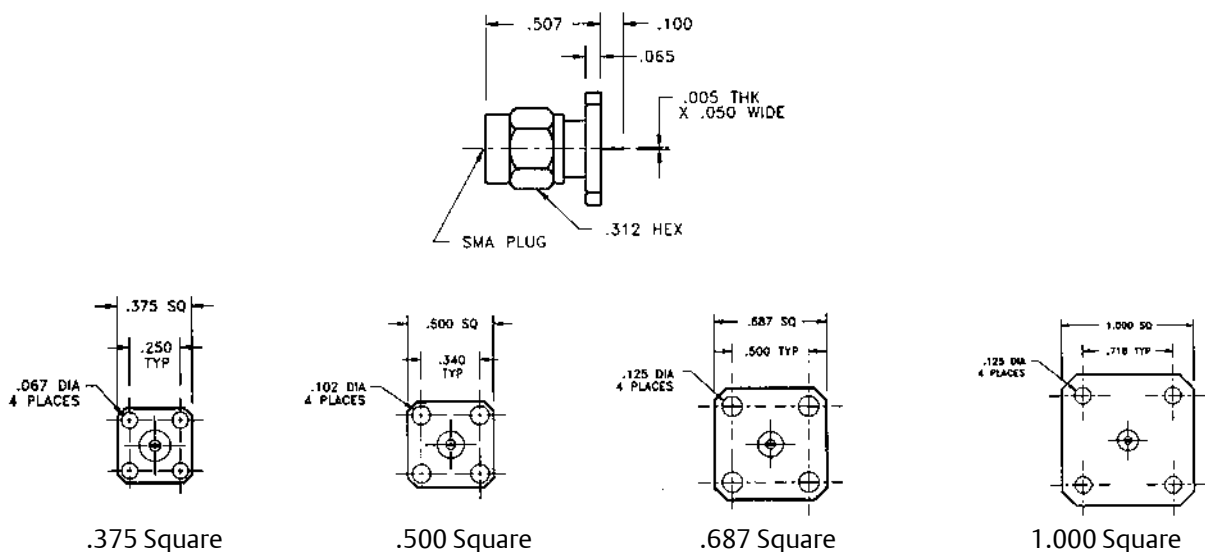

- Replace Connectors Without the Loss of Hermeticity
- Low VSWR and EMI/RFI Leakage
- Center Conductor Diameters of .012, .015, .018, and .02

Hermetically sealed microwave components that are required to meet the specifications of MIL-STD-883B and MIL-M-38510 must retain their seal integrity when subjected to a myriad of environmental tests which usually require an extensive amount of post electrical testing. During these tests, the connector(s) can become worn or damaged and it is often necessary to replace them. Midwest Microwave offers this series of Field Replaceable Drop-in Hermetically Sealed Connectors to satisfy the need for a connector that can be replaced without violating the hermeticity of the package and that will work efficiently together with a supplied hermetic seal that the user can solder or braze simply and directly into their microwave package. In addition, the connectors should be designed such that they will provide the maximum amount of EMI/RFI protection possible. Connectors in this series include a hermetic seal that is available in four different center conductor diameter sizes (.012, .015, .018, .020). The user must select the center conductor launch diameter depending on the microstrip line width and dielectric constant of the board material being used in the particular application.

Hermetic Seal – Solder / Braze

Performance Characteristics		
Connector Element	VSWR to 18.0 GHz	EMI/RFI Leakage (dB)
Connector Only	1.04 + .006 f	-(70 - f GHz)
Seal Only	1.02 + .003 f	-(70 - f GHz)
Connector + Seal	1.06 + .010 f	-(70 - f GHz)

Note: BMA (Blind Mate), 3.5mm, and 2.9mm Field Replaceable Drop-in Hermetic Receptacles are shown on pages 153-162.

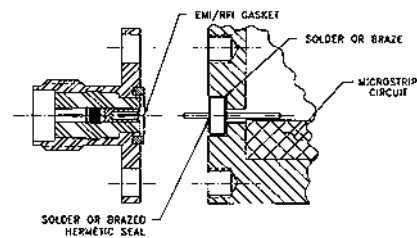

Drop-in Assembly - Flanged Connector

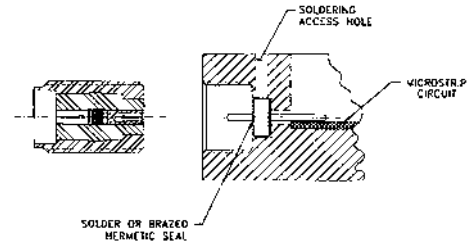

Drop-in Assembly - Feedthru Connector

Dimensions – inches					
Part No.	A	B	C	D	E
HRM-0001-95-DRP-00	.012	.100	.063	.180	.315
HRM-0002-95-DRP-00	.015	.100	.063	.180	.315
HRM-0003-95-DRP-00	.018	.112	.063	.180	.315
HRM-0004-95-DRP-00	.020	.158	.069	.070	.220

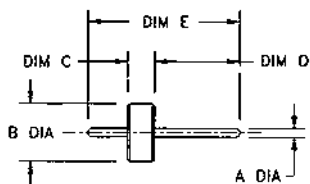

Gasket – EMI / RFI

Part No.
GSK-0054-99-DRP-54

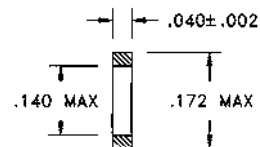

SMA Field Replaceable Launchers / Drop-in Hermetic Seals

Straight Flange Mount Female Jack Launcher With EMI / RFI Gasket

Mechanically Captured Center Contact

Part No. ** Connector & Seal **	Seal Pin Dia. inches (mm)	Flange Size	Mounting Hole Detail
SMA-5372-15-DRP-02	.012 (0.3)	.375 (9.5) Square	II
SMA-5373-15-DRP-02	.015 (0.5)	.375 (9.5) Square	II
SMA-5374-15-DRP-02	.018 (0.7)	.375 (9.5) Square	III
SMA-5572-15-DRP-02	.012 (0.3)	.500 (12.7) Square	IV
SMA-5573-15-DRP-02	.012 (0.3)	.500 (12.7) Square	IV
SMA-5574-15-DRP-02	.018 (0.5)	.500 (12.7) Square	V
SMA-5672-15-DRP-02	.012 (0.3)	.625 (15.9) Square	VI
SMA-5673-15-DRP-02	.015 (0.5)	.625 (15.9) Square	VI
SMA-5674-15-DRP-02	.018 (0.7)	.625 (15.9) Square	VII
SMA-5872-15-DRP-02	.012 (0.3)	.550 (14.0) Square	VII
SMA-5873-15-DRP-02	.015 (0.5)	.550 (14.0) Square	VII
SMA-5874-15-DRP-02	.018 (0.7)	.550 (14.0) Square	IX

Part No. ** Connector & Seal **	Seal Pin Dia. inches (mm)	Flange Size	Mounting Hole Detail
SMA-5362-15-DRP-02	.012 (0.3)	.375 (9.5) Square	II
SMA-5363-15-DRP-02	.015 (0.5)	.375 (9.5) Square	II
SMA-5364-15-DRP-02	.018 (0.7)	.375 (9.5) Square	III
SMA-5562-15-DRP-02	.012 (0.3)	.500 (12.7) Square	IV
SMA-5563-15-DRP-02	.012 (0.3)	.500 (12.7) Square	IV
SMA-5564-15-DRP-02	.018 (0.5)	.500 (12.7) Square	V
SMA-5662-15-DRP-02	.010 (0.3)	.625 (15.9) Square	VI
SMA-5663-15-DRP-02	.015 (0.5)	.625 (15.9) Square	VI
SMA-5664-15-DRP-02	.018 (0.7)	.625 (15.9) Square	VII
SMA-5862-15-DRP-02	.012 (0.3)	.550 (14.0) Square	VIII
SMA-5863-15-DRP-02	.015 (0.5)	.550 (14.0) Square	VIII
SMA-5864-15-DRP-02	.018 (0.7)	.550 (14.0) Square	IX

Note: Standard finish is passivated stainless steel. Please contact customer service for availability of gold-plated version. Mounting Hole Details II thru XI appear on page 144.

Straight Flange Mount Female Jack Launcher - Without EMI / RFI Gasket

Part No. ** Connector & Seal **	Seal Pin Dia.	Flange Size	Mounting Hole Detail
SMA-5561-15-DRP-02	.020	.500 Square	X
SMA-5261-15-DRP-02	.020	.625 Two Hole	XI

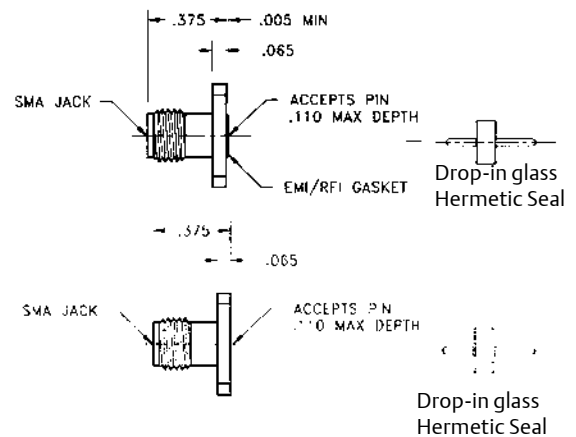

Flange Size Details

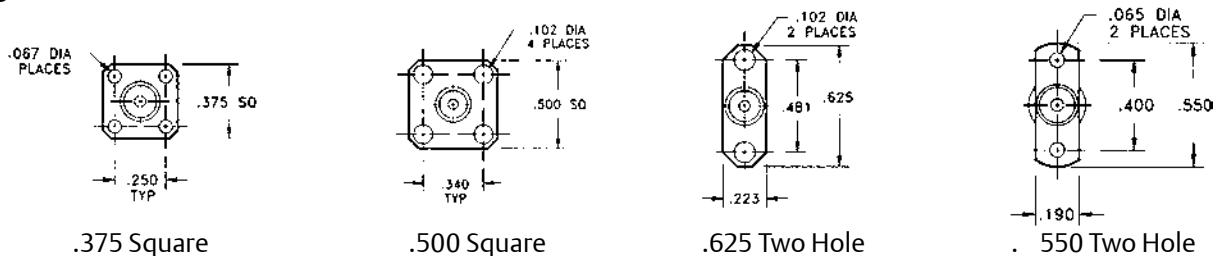

Note: Standard finish is passivated stainless steel. Please contact customer service for availability of gold-plated version.

Straight Flange Mount Male Plug Launcher with EMI / RFI Gasket

Mechanically Captured Center Contact

Part No. ** Connector & Seal **	Seal Pin Dia. inches (mm)	Flange Size	Mounting Hole Detail
SMA-5372-14-DRP-02	.012 (0.3)	.375 (9.5) Square	II
SMA-5373-14-DRP-02	.015 (0.5)	.375 (9.5) Square	II
SMA-5374-14-DRP-02	.018 (0.7)	.375 (9.5) Square	III
SMA-5572-14-DRP-02	.012 (0.3)	.500 (12.7) Square	IV
SMA-5573-14-DRP-02	.012 (0.3)	.500 (12.7) Square	IV
SMA-5574-14-DRP-02	.018 (0.5)	.500 (12.7) Square	V
SMA-5672-14-DRP-02	.012 (0.3)	.625 (15.9) Square	VI
SMA-5673-14-DRP-02	.015 (0.5)	.625 (15.9) Square	VI
SMA-5674-14-DRP-02	.018 (0.7)	.625 (15.9) Square	VII
SMA-5872-14-DRP-02	.012 (0.3)	.550 (14.0) Square	VIII
SMA-5873-14-DRP-02	.015 (0.5)	.550 (14.0) Square	VII
SMA-5874-14-DRP-02	.018 (0.7)	.550 (14.0) Square	IX

Part No. ** Connector & Seal **	Seal Pin Dia. inches (mm)	Flange Size	Mounting Hole Detail
SMA-5362-14-DRP-02	.012 (0.3)	.375 (9.5) Square	II
SMA-5363-14-DRP-02	.015 (0.5)	.375 (9.5) Square	II
SMA-5364-14-DRP-02	.018 (0.7)	.375 (9.5) Square	III
SMA-5562-14-DRP-02	.012 (0.3)	.500 (12.7) Square	IV
SMA-5563-14-DRP-02	.012 (0.3)	.500 (12.7) Square	IV
SMA-5564-14-DRP-02	.018 (0.5)	.500 (12.7) Square	V
SMA-5662-14-DRP-02	.010 (0.3)	.625 (15.9) Square	VI
SMA-5663-14-DRP-02	.015 (0.5)	.625 (15.9) Square	VI
SMA-5864-14-DRP-02	.018 (0.7)	.625 (15.9) Square	VII
SMA-5862-14-DRP-02	.012 (0.3)	.550 (14.0) Square	VIII
SMA-5863-14-DRP-02	.015 (0.5)	.550 (14.0) Square	VIII

Note: Standard finish is passivated stainless steel. Please contact customer service for availability of gold-plated version. Mounting Hole Details II thru XI appear on page 144.

Straight Flange Mount Female Jack Launcher - Without EMI / RFI Gasket

Part No. ** Connector & Seal **	Seal Pin Dia.	Flange Size	Mounting Hole Detail
SMA-5561-14-DRP-02	.020	.500 Square	X
SMA-5261-14-DRP-02	.020	.500 Square	X

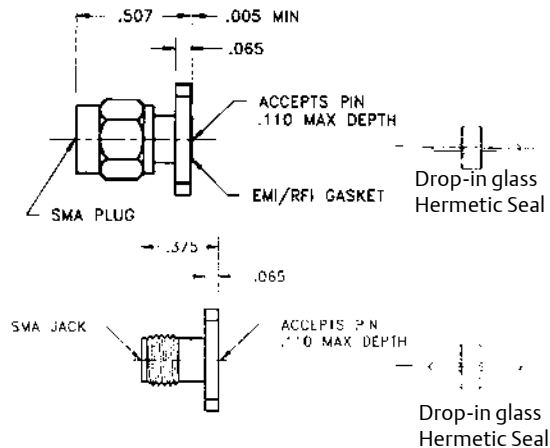

Flange Size Details

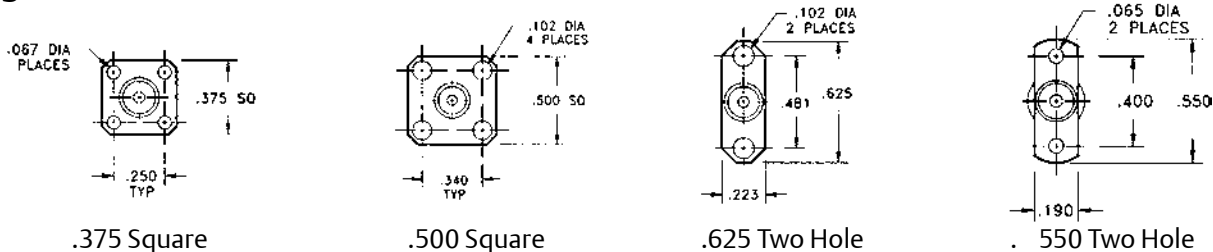

Note: Standard finish is passivated stainless steel. Please contact customer service for availability of gold-plated version.

Recommended Mounting Hole Detail / For Field Replaceable Hermetic Launchers

Part No.	Dim A
.012	.027
.015	.034
.018	.041
.020	.046

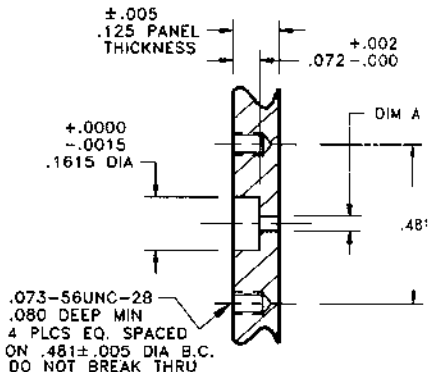
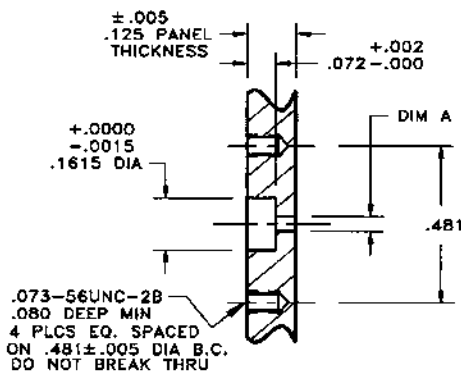
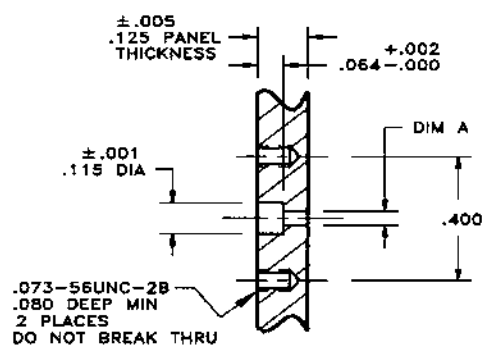
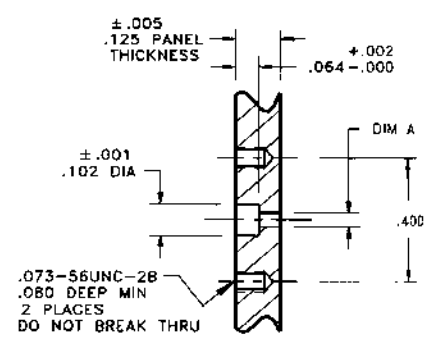
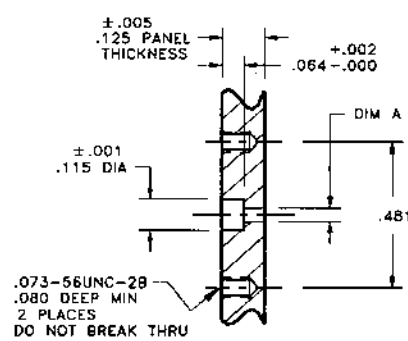
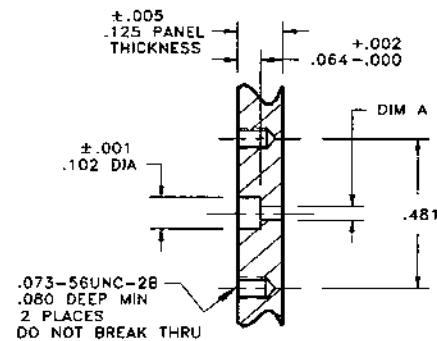
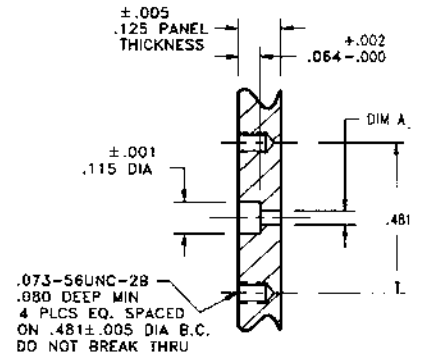
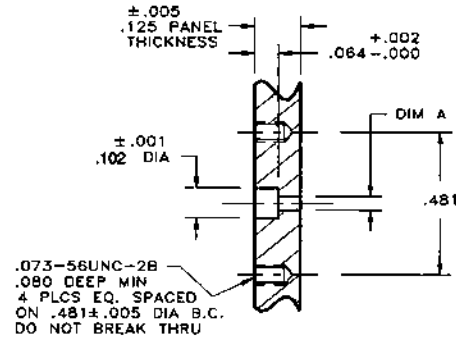
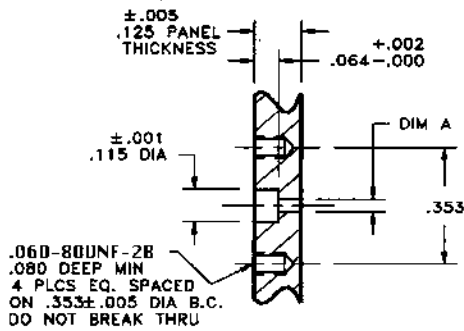
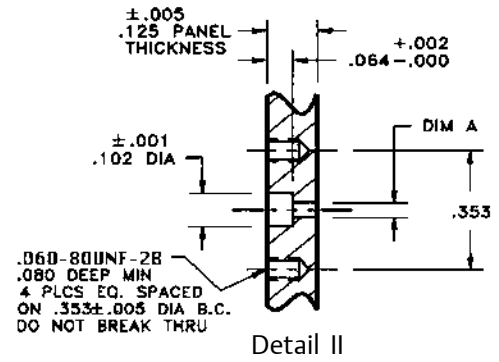
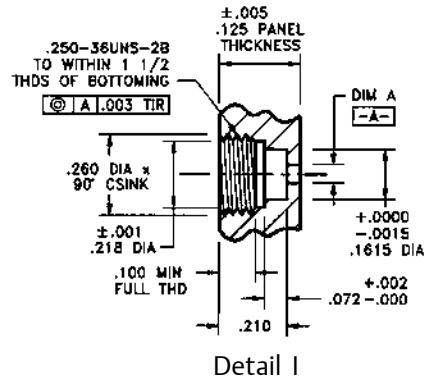

Straight Flange Mount Female Jack Receptacle - Flush Mount

Part No.

SMA-5512-35-HRM-02

Note: Standard finish is passivated stainless steel.
Please contact customer service for availability of gold-plated version.

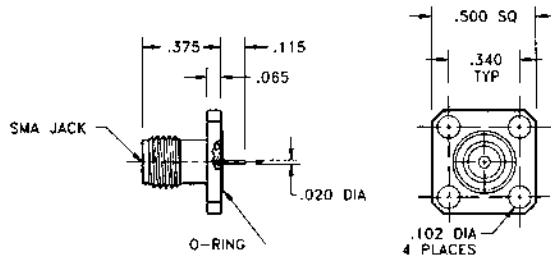

Straight Flange Mount Female Jack Receptacle - Boss Mount

Part No.	Dim A
SMA-5581-35-HRM-02	.089 (2.3)
SMA-5582-35-HRM-02	.121 (3.1)
SMA-5583-35-HRM-02	.183 (4.6)

Note: Standard finish is passivated stainless steel.
Please contact customer service for availability of gold-plated version.

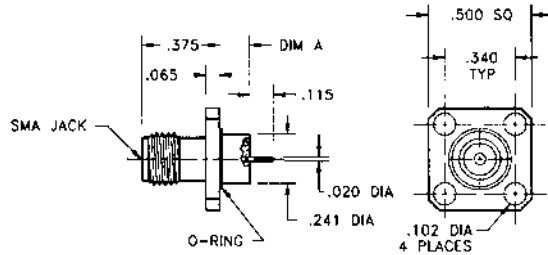

Straight Bulkhead Feedthru Female Jack Receptacle - Rear Mount

Part No.

SMA-5012-31-HRM-02

Note: Standard finish is gold plating for direct soldering to circuit board.

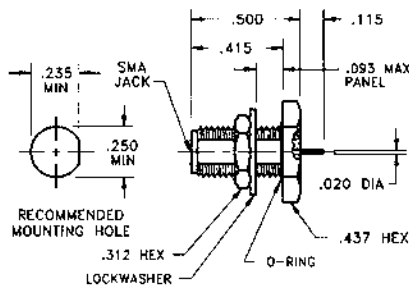

Straight Bulkhead Feedthru Female Jack Receptacle - Front Mount

Part No.

SMA-5012-32-HRM-02

Note: Standard finish is passivated stainless steel.
Please contact customer service for availability of gold-plated version.

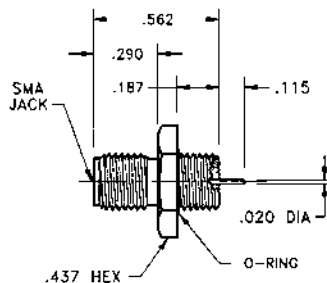

Hermetically Sealed Plug Receptacles

Straight Flange Mount Male Plug Receptacle - Flush Mount

Part No.

SMA-5512-34-HRM-02

Note: Standard finish is passivated stainless steel.

Please contact customer service for availability of gold-plated version.

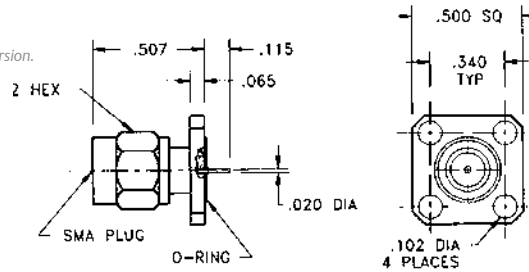

Straight Flange Mount Male Plug Receptacle - Boss Mount

Part No.

SMA-5581-34-HRM-02

Dim A

.089 (2.3)

SMA-5582-34-HRM-02

.121 (3.1)

SMA-5583-34-HRM-02

.183 (4.6)

Note: Standard finish is passivated stainless steel.

Please contact customer service for availability of gold-plated version.

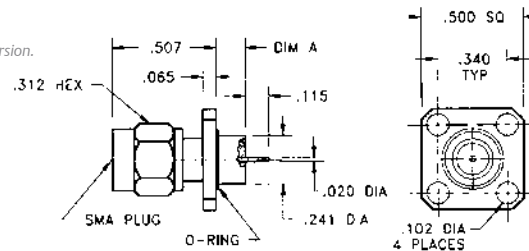

Bulkhead Feedthru Male Plug Receptacle - Front Mount

Part No.

SMA-5012-39-HRM-02

Note: Standard finish is passivated stainless steel.

Please contact customer service for availability of gold-plated version.

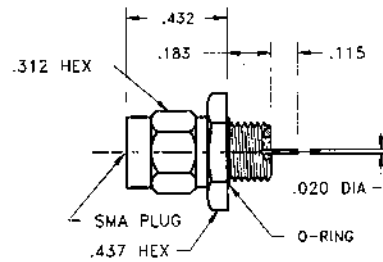

Straight Panel Feedthru Female Jack Receptacle - Field Replaceable

Part No.

SMA-5974-12-DRP-02

Product

Connector and Seal

SMA-5961-12-DRP-02

Connector only

HRM-0004-95-DRP-02

Seal only

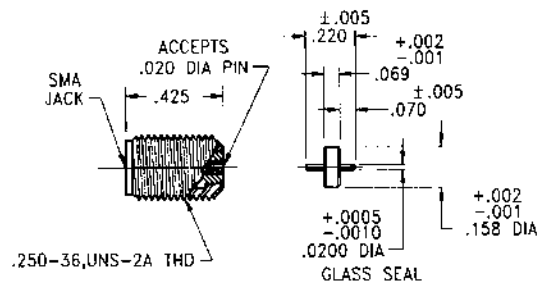

Straight Male Cable Plug

Part No.	Cable Type (RG/U)	Fig.
SSM-0085-92-000-00	405 (.085 Dia.)	I
SSM-0085-79-000-00	405 (.085 Dia.)	II

Note: Standard finish is gold plating on housing for direct solder to cable and passivated coupling nut.

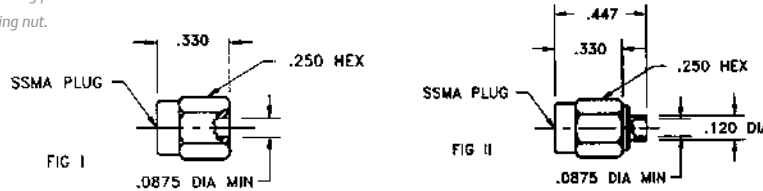

Straight Bulkhead Feedthru Female Cable Jack

Part No.	Cable Type (RG/U)
SSM-0085-83-000-00	405 (.085 Dia.)

Note: Standard finish is gold plating for direct soldering to cable.

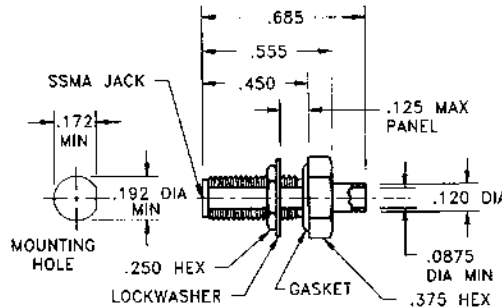

Straight Panel Mount Female Cable Jack - 4 Hole

Part No.	Cable Type (RG/U)
SSM-0085-84-000-00	405 (.085 Dia.)

Note: Standard finish is passivated stainless steel.
Please contact customer service for availability of gold-plated version.

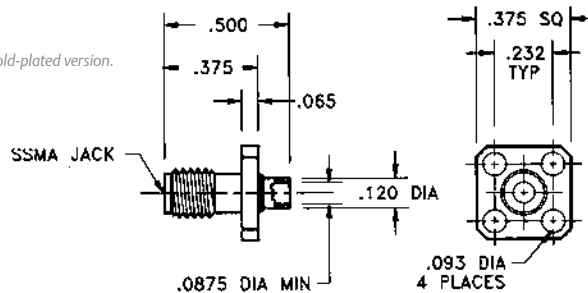

Right Angle Male Cable Plug

Part No.	Cable Type (RG/U)
SSM-0085-80-000-02	405 (.085 Dia.)

Note: Standard finish is gold plating on housing for direct solder to semi-rigid cable and passivated coupling nut.
Detail interface dimensions and RG/U cable information can be found in the appendix.

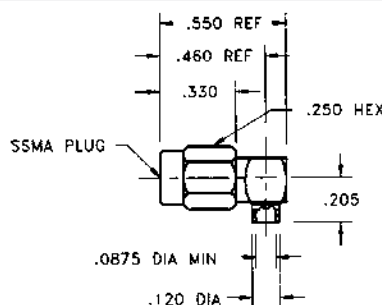

SSMA Subminiature Type / Crimp Attachment for Flexible Cable

Straight Male Cable Plug

Part No.	Dim A
SSM-1188-55-000-02	174; 179; 187; 188; 316
SSM-1196-55-000-02	178; 196

Note: Standard finish is passivated stainless steel.

Please contact customer service for availability of gold-plated version.

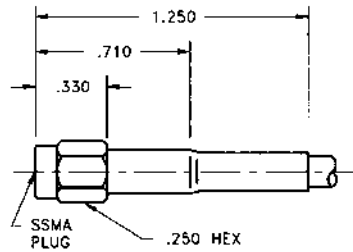

Straight Bulkhead Feedthru Female Cable Jack

Part No.	Dim A
SSM-1188-59-000-02	174; 179; 187; 188; 316
SSM-1196-59-000-02	178; 196

Note: Standard finish is passivated stainless steel.

Please contact customer service for availability of gold-plated version.

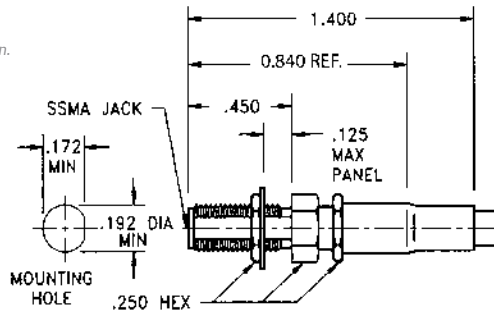

Straight Panel Mount Female Cable Jack

Part No.	Dim A
SSM-1188-54-000-02	174; 179; 187; 188; 316
SSM-1196-54-000-02	178; 196

Note: Standard finish is passivated stainless steel.

Please contact customer service for availability of gold-plated version.

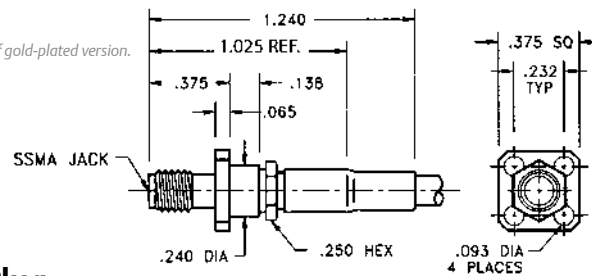

Right Angle Male Cable Plug

Part No.	Dim A
SSM-1188-56-000-02	174; 179; 187; 188; 316
SSM-1196-56-000-02	178; 196

Note: Standard finish is passivated stainless steel.

Please contact customer service for availability of gold-plated version.

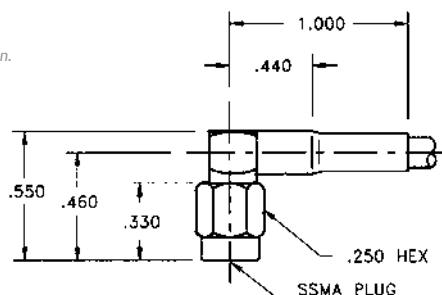

Straight Flange Mount Female Jack Receptacle - 4 Hole

Part No.

SSM-5340-15-POT-02

Note: Standard finish is passivated stainless steel.
Please contact customer service for availability of gold-plated version.

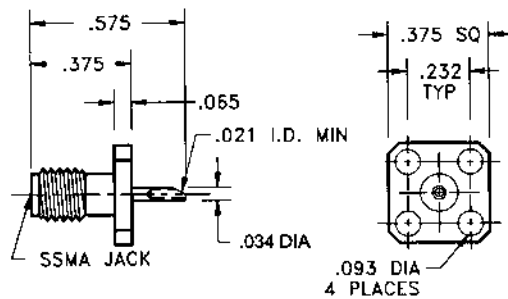

Straight Flange Mount Female Jack Receptacle - 2 Hole

Part No.

SSM-5240-15-POT-02

Note: Standard finish is passivated stainless steel.
Please contact customer service for availability of gold-plated version.

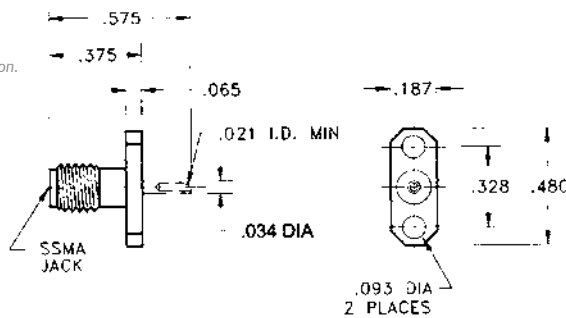

Straight Bulkhead Feedthru Female Jack Receptacle - Rear Mount

Part No.

SSM-5040-11-POT-02

Note: Standard finish is passivated stainless steel.
Please contact customer service for availability of gold-plated version.

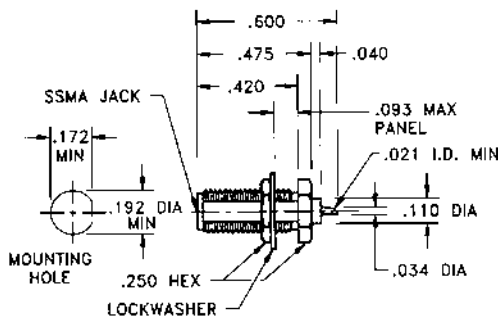

Right Angle Flange Mount Female Jack Receptacle

Part No.

SSM-5340-16-POT-02

Note: Standard finish is gold plating on housing for direct solder to semi-rigid cable and passivated coupling nut. Detail interface dimensions and RG/U cable information can be found in the appendix.

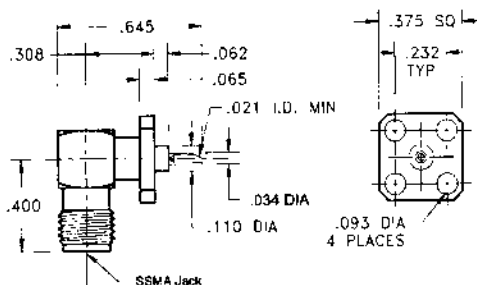

SSMA Panel Mount Receptacles / Terminal, Tab & Printed Circuit Types

Straight Flange Mount Female Jack Receptacle - 4 Hole

Part No.

SSM-5310-15-TRM-02

Note: Standard finish is passivated stainless steel.

Please contact customer service for availability of gold-plated version.

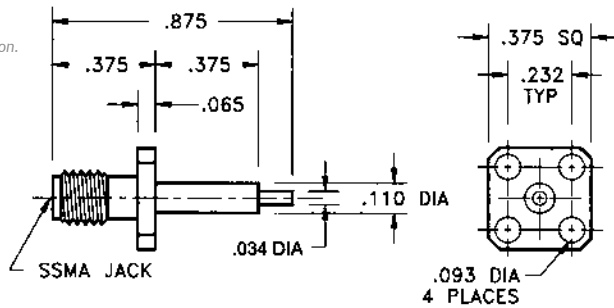

Straight Flange Mount Female Jack Receptacle - 2 Hole

Part No.

SSM-5210-15-TRM-02

Note: Standard finish is passivated stainless steel.

Please contact customer service for availability of gold-plated version.

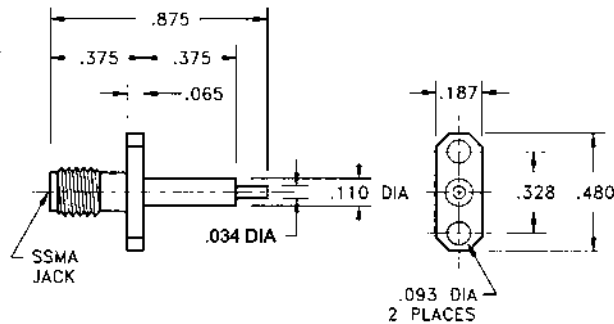

Straight Flange Mount Female Jack Receptacle

Part No.

SSM-5330-15-TAB-02

Note: Standard finish is passivated stainless steel.

Please contact customer service for availability of gold-plated version.

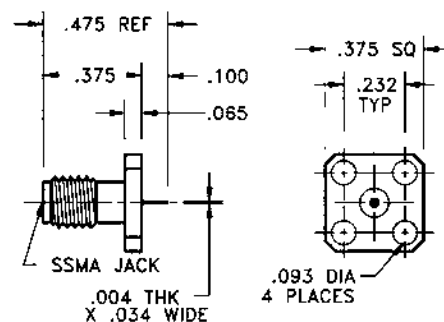

Straight Printed Circuit Board Mount Female Jack Receptacle

Part No.

SSM-5010-93-PCB-00

Note: Standard finish is gold plating for direct solder to circuit board. Detail interface dimension information can be found in the Appendix.

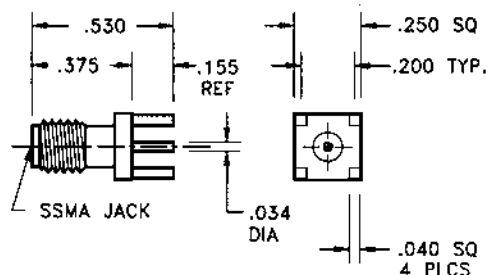

Straight Male Cable Plug

Part No.	Cable Type	Dim A
SMM-1196-55-000-00	RG196/U	0.450
SMM-0034-79-000-00	.034 Semi-Rigid	0.360
SMM-0047-79-000-00	.047 Semi-Rigid	0.360

Note: Standard finish is gold plating. Please contact customer service for availability of passivated stainless steel version.

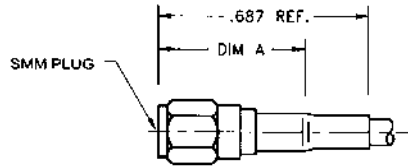

Straight Bulkhead Feedthru Female Cable Jack

Part No.	Cable Type	Dim A
SMM-1196-59-000-00	RG196/U	0.565
SMM-0034-83-000-00	.034 Semi-Rigid	0.458
SMM-0047-83-000-00	.047 Semi-Rigid	0.458

Note: Standard finish is gold plating. Please contact customer service for availability of passivated stainless steel version.

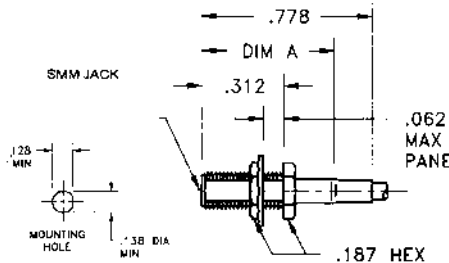

Straight Panel Mount Female Cable Jack - 4 Hole

Part No.	Cable Type	Dim A
SMM-1196-54-000-00	RG196/U	0.440
SMM-0034-84-000-00	.034 Semi-Rigid	0.330
SMM-0047-84-000-00	.047 Semi-Rigid	0.330

Note: Standard finish is gold plating. Please contact customer service for availability of passivated stainless steel version.

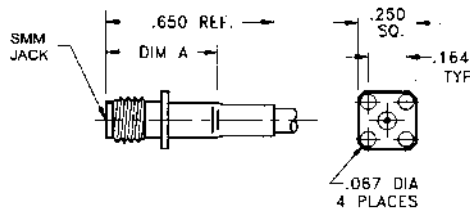

Right Angle Male Cable Plug

Part No.	Cable Type	Dim A	Dim B
SMM-1196-56-000-00	RG196/U	0.360	0.280
SMM-0034-80-000-00	.034 Semi-Rigid	0.260	0.180
SMM-0047-80-000-00	.047 Semi-Rigid	0.260	0.180

Note: Standard finish is gold plating. Please contact customer service for availability of passivated stainless steel version.

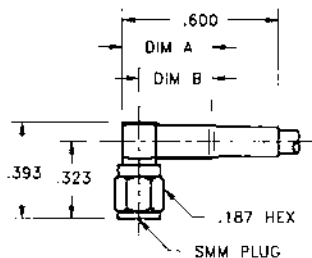

SMM Microminiature Receptacles / Panel • Bulkhead • Printed Circuit

Straight Flange Mount Female Jack Receptacle - 4 Hole

Part No.

SMM-5819-15-TRM-00

Note: Standard finish is gold plating. Please contact customer service for availability of passivated stainless steel version.

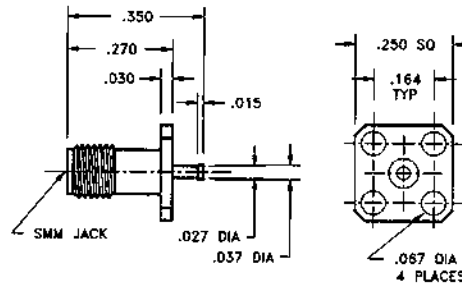

Straight Bulkhead Feedthru Female Jack Receptacle- Rear Mount

Part No.

SMM-5019-11-TRM-00

Note: Standard finish is gold plating. Please contact customer service for availability of passivated stainless steel version.

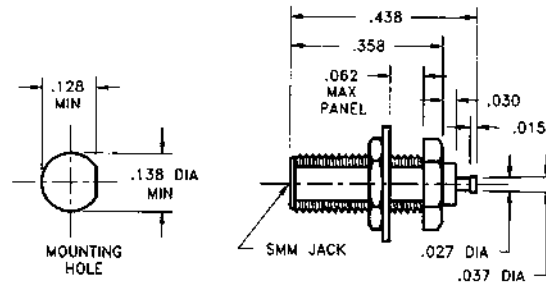

Straight Printed Circuit Board Mount Female Jack Receptacle

Part No.

SMM-5010-93-PCB-00

Note: Standard finish is gold plating for direct soldering to printed circuit board.

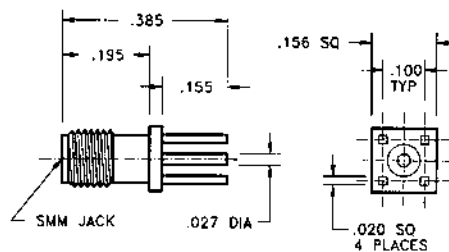

Right Angle Printed Circuit Board Mount Female Jack Receptacle

Part No.

SMM-5010-94-PCB-00

Note: Standard finish is gold plating for direct soldering to printed circuit board.

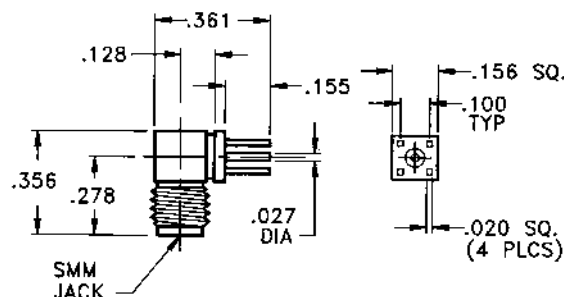

- Modular Interconnection System
- Save Space and Weight
- Eliminate Excessive Cable Assemblies
- Module to Motherboard and Rack and Panel

Midwest Microwave's series of BMA blind mate connectors were designed to provide a solution to a number of microwave and RF interconnect problems. Through their use connections between RF or microwave modules and a motherboard can be accomplished with a minimum amount of cable interconnections that use space and add weight. The motherboard could be the base of a drawer or rack containing a portion of the system that in turn plugs into a back plane that receives a series of these module filled drawers that comprise the complete rack and panel RF or microwave system. The connectors provide both rigid or floating type interconnect arrangements and take into consideration the need for axial and radial misalignment.

Specifications		
Impedance:	50 Ohms	
Frequency:	DC to 22.0 GHz	
Temperature Range:	-65 to +125° C	
VSWR:	RG 402 (.141)	RG 405 (.085)
	Semi-Rigid	Semi-Rigid
DC-18.0 GHz	1.02 + .005 f (GHz)	1.05 + .005 f (GHz)
18.0-22.0 GHz	1.02 + .008 f (GHz)	1.05 + .009 f (GHz)
Transmission Loss:	.003 √f (GHz)	.003 13 √f (GHz)
Insulation Resistance:	5000 megohm	5000 megohm
Dielectric Withstanding Voltage:	1500 volts RMS	1000 volts RMS
Corona Ext Voltage:	375 volts @70,000 ft.	335 volts @ 70,000 ft.
RF Leakage @ Interface:	-(90-fGHz) dB min	-(90-fGHz) dB min
RF High Potential-5 MHz:	1,000 volts RMS	670 volts RMS
Power:	300 Watts at 3 GHz (sea level) at room temp.	

Note: See page 128 for other related general, mechanical, and environmental specifications.

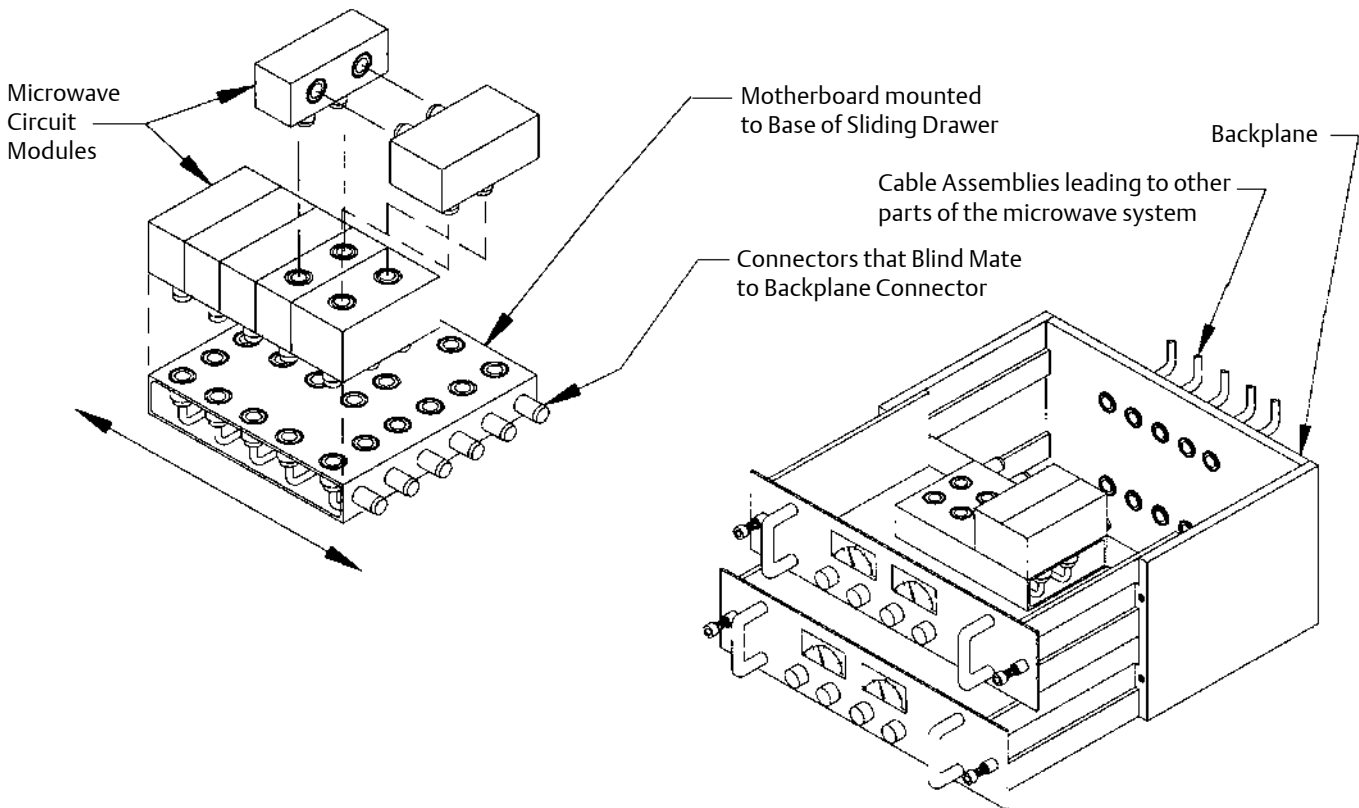

BMA – Blind Mate Connectors / Rigid and Float Mount Applications

Rigid Mount BMA Connectors

Rigid Mount Blind Mate Connectors are usually used for applications involving microwave modules and microwave integrated circuit components where space and close tolerances are important considerations. Because BMA connectors can accommodate a small amount of axial and radial misalignment, they are a favorable choice for a multi-module package arrangement. Interlocking modules should use jack screws to keep them together for proper performance. A typical dimensional layout of an array of rigid mount BMA connectors showing tolerance considerations is shown below.

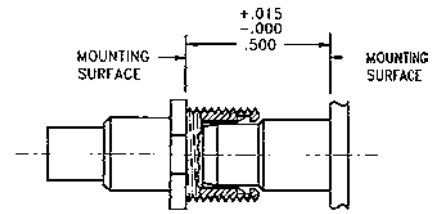

Axial Misalignment

BMA rigid mount blind mate connector interfaces can accommodate a limited amount of axial misalignment. The recommended design limits and maximum allowable interface separation are shown below.

BMA Interface	Maximum Separation	Recommended Design Limit
Male/Female	.030 (0.762)	.015 (0.381)

Radial Misalignment

BMA rigid mount blind mate connector interfaces can accommodate a limited amount of radial misalignment without performance degradation. The design limits are shown below.

BMA Interface	True Position Mounting Hole Centerline Tolerance	Total Connector Misalignment per Mated Pair
Male/Female	.003 (0.076)	.008 (0.203)

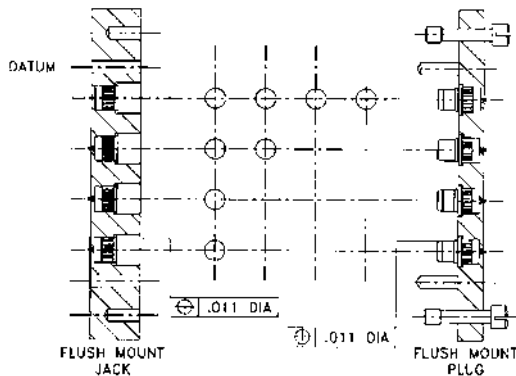

Float Mount BMA Connectors

Float Mount Blind Mate Connectors are very useful for applications involving rack and panel assemblies and multiple connector mating arrangements where the maximum of axial and radial misalignment tolerance is required. Midwest Microwave's BMA float mount jack connectors provide an additional external float mechanism that when added to the normal misalignment tolerance of the BMA interface, provides the necessary misalignment tolerance to allow successful mating of the interfaces.

BMA Interface	Axial Misalignment	Radial Misalignment*
Male/Female	.050 (1.270)	.020 (0.508)

A Mating Preload is recommended

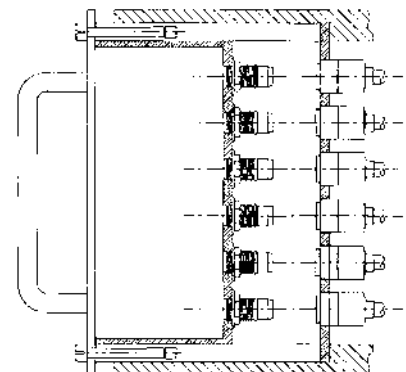
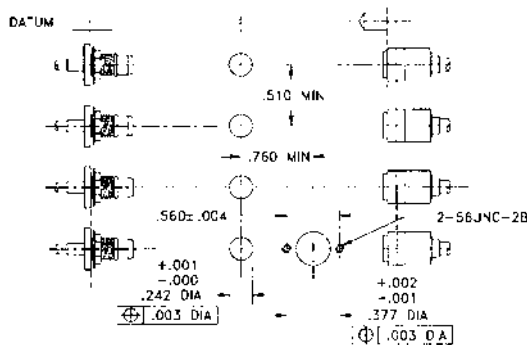
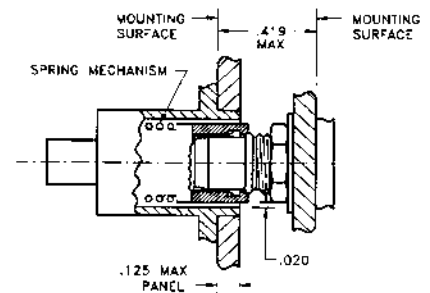

Note: With mounting hole centerline dimensioned from a pre-designed datum of $\varnothing 1.006$ dia.

Bulkhead Feedthru Cable Plug - Rear Mount

Part No.	Cable Type	Dim A	Dim B
BMA-0141-86-000-00	141 (RG402)	.143 (3.6)	.180 (4.6)
BMA-0085-86-000-00	085 (RG405)	.089 (2.2)	.120 (3.0)

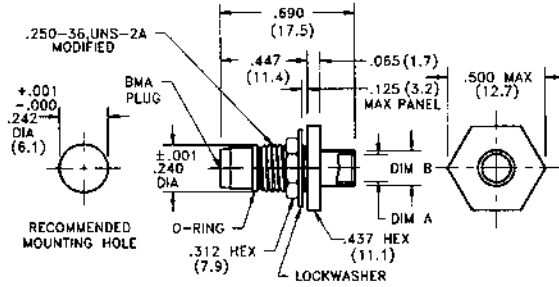

Bulkhead Feedthru Cable Jack - Rigid Rear Mount

Part No.	Cable Type	Dim A	Dim B
BMA-0141-83-000-00	141 (RG402)	.143 (3.6)	.180 (4.6)
BMA-0085-83-000-00	085 (RG405)	.089 (2.2)	.120 (3.0)

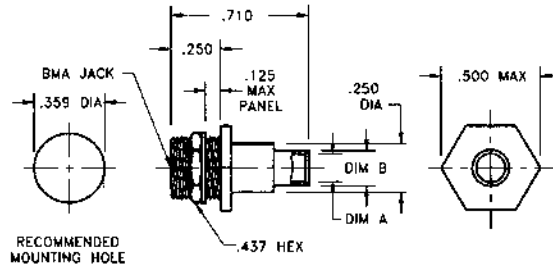

Flange Mount Cable Jack - Floating Rear Mount

Part No.	Cable Type	Dim A	Dim B
BMA-0141-87-000-02	141 (RG402)	.143 (3.6)	.180 (4.6)
BMA-0085-87-000-02	085 (RG405)	.089 (2.2)	.120 (3.0)

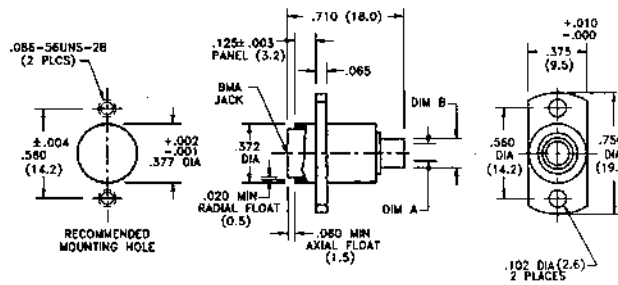

Low Profile Bulkhead Feedthru Cable Jack - Floating Rear Mount

Part No.	Cable Type	Dim A	Dim B
BMA-0141-85-000-02	141 (RG402)	.143 (3.6)	.180 (4.6)
BMA-0085-85-000-02	085 (RG405)	.089 (2.2)	.120 (3.0)2

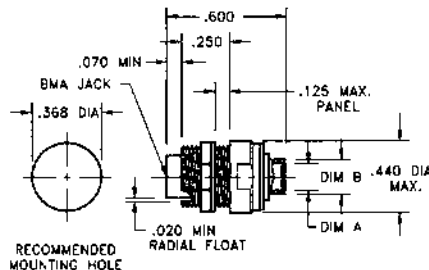

BMA for Flexible Cable / Crimp Attachment Type

Bulkhead Feedthru Male Cable Plug - Rear Mount

Part No.	Cable Type
BMA-1055-51-000-02	55; 142; 223; 400
BMA-1188-51-000-02	174; 179; 187; 188; 316

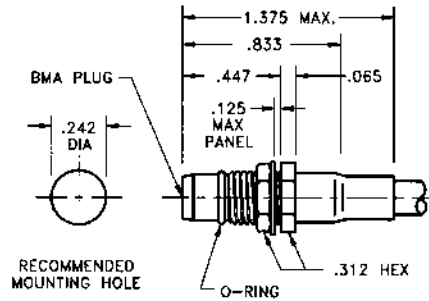

Bulkhead Feedthru Female Cable Jack - Rigid Rear Mount

Part No.	Cable Type
BMA-1055-59-000-02	55; 142; 223; 400
BMA-1188-59-000-02	174; 179; 187; 188; 316

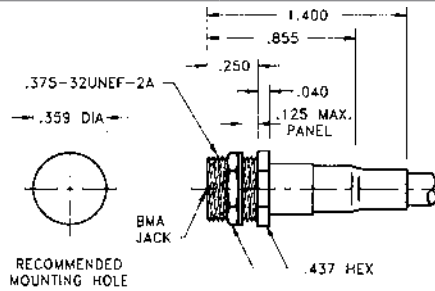

Flange Mount Female Cable Jack - Floating Rear Mount

Part No.	Cable Type
BMA-1055-61-000-02	55; 142; 223; 400
BMA-1188-61-000-02	174; 179; 187; 188; 316

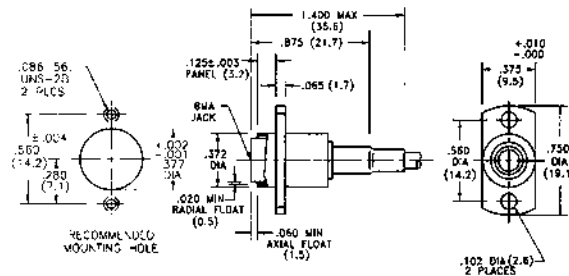

Low Profile Panel Feedthru Female Cable Jack - Floating Rear Mount *

Part No.	Cable Type
BMA-1055-53-000-02	55; 142; 223; 400
BMA-1188-53-000-02	174; 179; 187; 188; 316

Note: *The unit immediately above is also available for direct solder semi-rigid cable as BMA-0141-53-000-00 and BMA-0085-53-000-00. Detail mounting information is on the individual outline drawings. Detail interface dimensions and RG/U cable information can be found in the appendix.

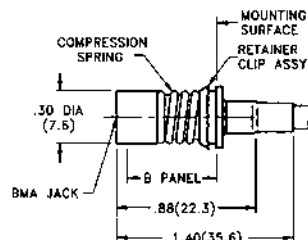

Flange Mount Male Plug - 2 Hole

Part No.
BMA-5210-14-TRM-02

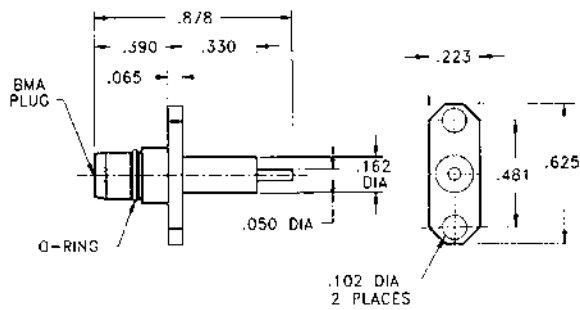

Flange Mount Female Jack - 2 Hole

Part No.
BMA-5210-15-TRM-02

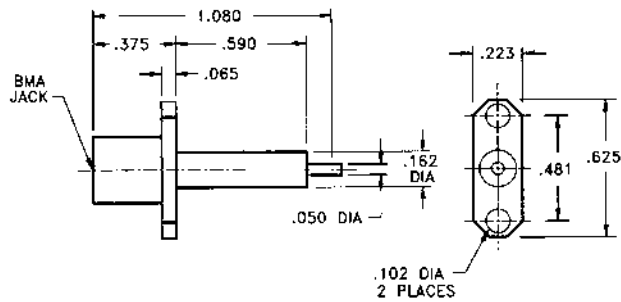

Flange Mount Male Plug - 4 Hole

Part No.
BMA-5510-14-TRM-02

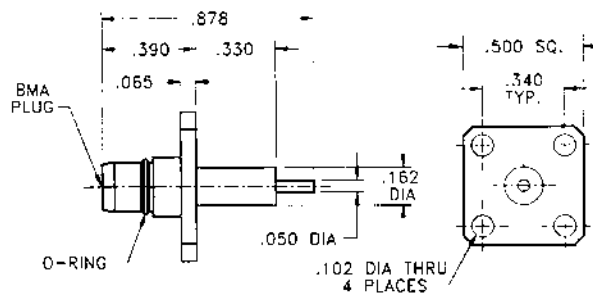

Flange Mount Female Jack - 4 Hole

Part No.
BMA-5510-15-TRM-02

Note: Detail interface dimensions and RG/U cable information can be found in the appendix.

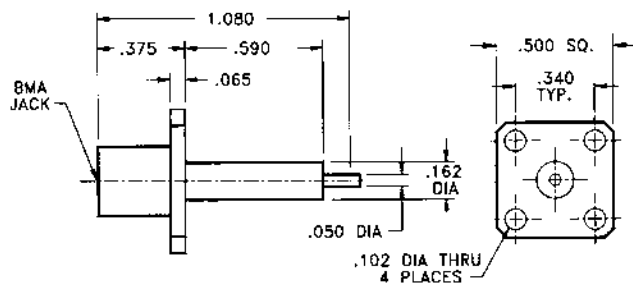

BMA Blind Mate Receptacles / Threaded and Press Fit Type

Panel Feedthru Male Plug - Threaded Type

Part No.

BMA-5918-19-TRM-02

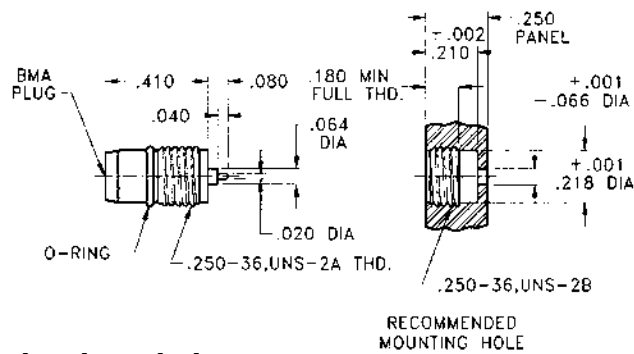

Panel Feedthru Female Jack - Threaded Type

Part No.

BMA-5018-12-TRM-02

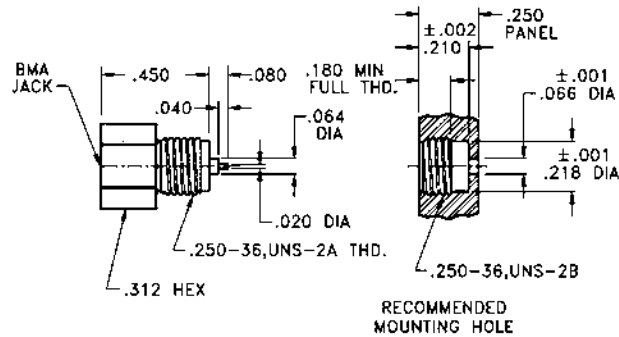

Panel Feedthru Male Plug - Press Fit Type

Part No.

BMA-5012-10-TRM-02

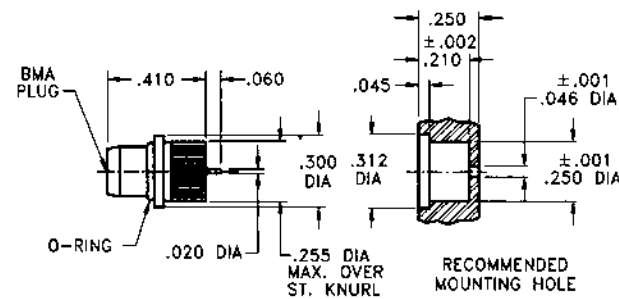

Panel Feedthru Female Jack - Press Fit Type

Part No.

BMA-5012-12-TRM-02

Note: Detail interface dimensions and RG/U cable information can be found in the appendix.

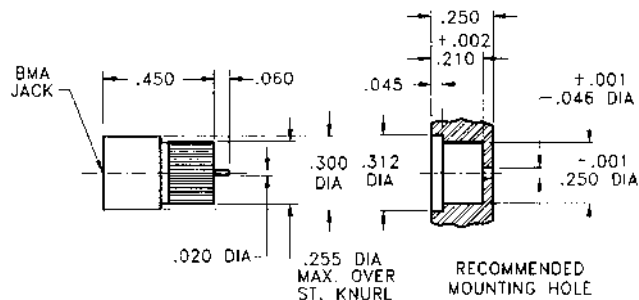

Straight Male Plug Receptacle - Captured Contact

Part No.

BMA-5010-91-PCB-00

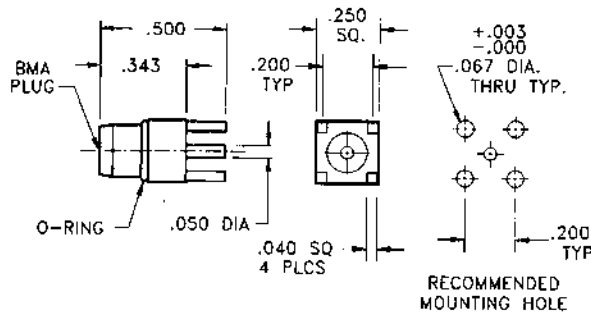

Straight Female Jack Receptacle - Captured Contact

Part No.

BMA-5010-93-PCB-00

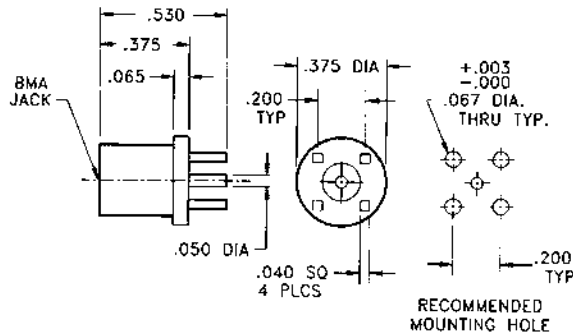

Right Angle Male Plug Receptacle - Captured Contact

Part No.

BMA-5010-90-PCB-00

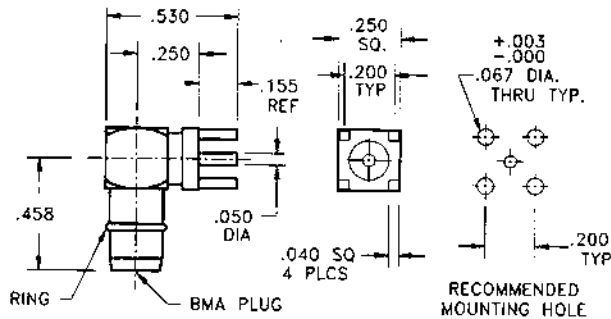

Right Angle Female Jack Receptacle - Captured Contact

Part No.

BMA-5010-94-PCB-00

Note: Detail interface dimension information can be found in the appendix.

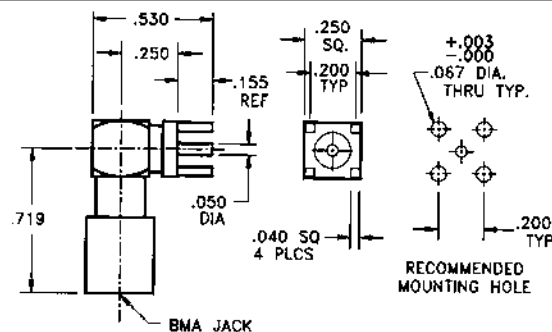

BMA Blind Mate Receptacles / Stripline and Drop-In Hermetic Types

Straight Surface Launched Male Plug - Non-Captured Contact

Part No.	Dim A
BMA-6858-44-STR-02	.062
BMA-6859-44-STR-02	.125
BMA-6856-44-STR-02	.250

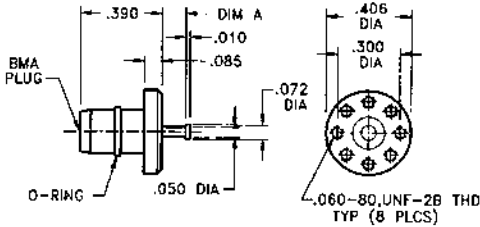

Straight Surface Launched Female Jack - Non-Captured Contact

Part No.	Dim A
BMA-6858-43-STR-02	.062
BMA-6859-43-STR-02	.125
BMA-6856-43-STR-02	.250

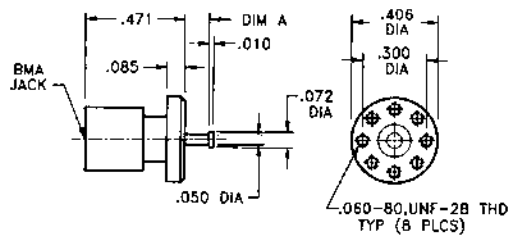

Straight Panel Feedthru Male Plug - Drop-in Hermetic

Part No.	Product
BMA-5075-12-DRP-02	Connector and Seal
BMA-5061-12-DRP-02	Connector only
HRM-0004-95-DRP-02	Seal only

Note: Recommended Mounting Hole Detail I on page 147.
Detail interface dimensions can be found in the appendix.

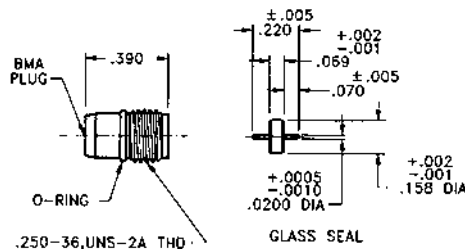

Straight Panel Feedthru Female Jack - Drop-in Hermetic

Part No.	Product
BMA-5075-12-DRP-02	Connector and Seal
BMA-5061-12-DRP-02	Connector only
HRM-0004-95-DRP-02	Seal only

Note: Recommended Mounting Hole Detail I on page 147.
Detail interface dimensions can be found in the appendix.

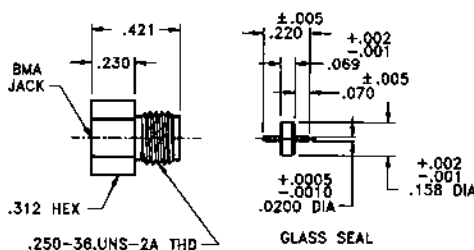

2.9mm Precision Connectors

Straight Male Cable Plug for .085 Dia. Semi-Rigid Cable

Part No.	Cable Type
29M-0085-79-000-02	.085 Semi-Rigid

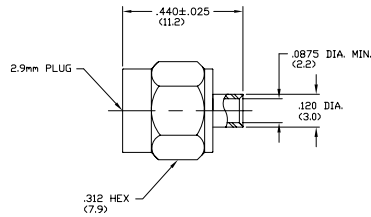

Straight Female Cable Jack for .085 Dia. Semi-Rigid Cable

Part No.	Cable Type
29M-0085-89-000-02	.085 Semi-Rigid

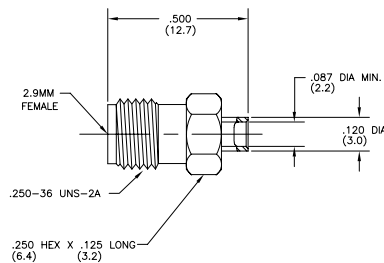

Straight Flange Mount Female Jack - Field Replaceable Drop-in Hermetic

Part No.	Accepts Pin Dia A
29M-5572-15-DRP-02	.012
29M-5573-15-DRP-02	.015
29M-5574-15-DRP-02	.018
29M-5575-15-DRP-02	.020

Note: Two Hole flange versions are also available.

To specify, change fifth digit from "5" to "2".

Example: 29M-5272-15-DRP-02.

Recommended Mounting Hole Detail on page 147.

Detail interface dimensions can be found in the appendix.

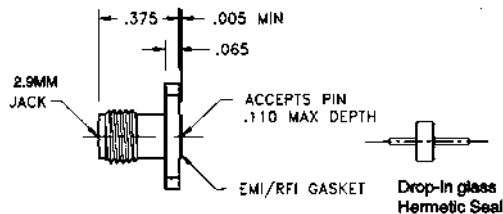

Straight Panel Feedthru Female Jack - Field Replaceable Drop-in Hermetic

Part No.	Accepts Pin Dia A
29M-5572-12-DRP-02	.012
29M-5573-12-DRP-02	.015
29M-5574-12-DRP-02	.018
29M-5575-12-DRP-02	.020

Note: Standard finish for all products on this page is passivated stainless steel.

Please contact customer service for availability of gold-plated version.

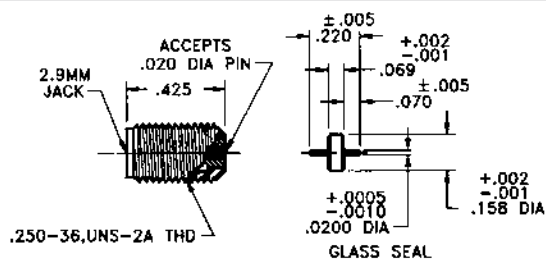

The 7mm Precision Connector is a well known and well used international standard in the microwave industry. It is hermaphroditic (sexless) and is found on many types of precision microwave and R.F. test equipment. Because of this, it is offered on a wide variety of precision adapters shown in the "Between Series" adapter section of this catalog to facilitate the testing of a broad spectrum of products with other types of connector interfaces. It is provided here for the user who chooses to construct either a precision component, a custom piece of test equipment, or sets of precision test cable assemblies for laboratory use. Units are available for use on 7mm (.2756 I.D.) air lines as well as .141 Dia. semi-rigid cable and other standard or low loss, phase stable, flexible cables. A more economical sexed (outer conductor only) version is also offered in threaded plug and jack versions that are completely compatible with the sexless type without any degradation of performance.

Precision 7 mm Connectors are ideal for a wide assortment of applications

Specifications	
Impedance:	50 Ohms
Frequency Range:	0 – 18.0 GHz
VSWR:	1.003 + .002 f (GHz)
Construction:	
Coupling Mechanism:	Stainless Steel
Outer Housing:	Beryllium Copper
Center Conductor:	Beryllium Copper six contact types

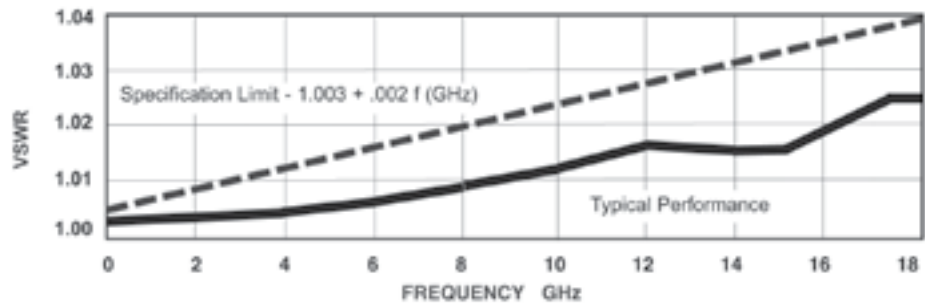

Preparation of Precision Airline Mounting

Careful adherence to the mounting dimensions indicated for the outer and inner conductor elements is required for the attainment of precision performance.

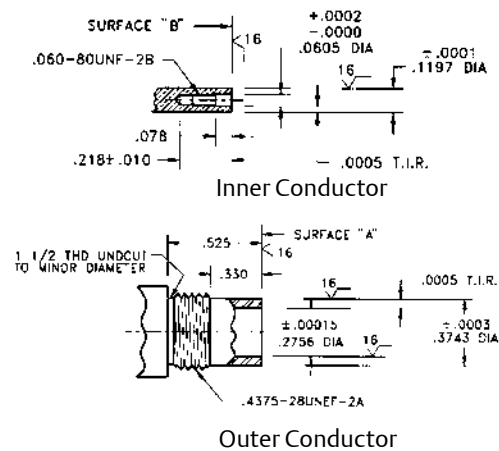

7mm Precision Connectors

7mm Precision Connector for Airline

Part No.

7MM-2602-7M-HEX-02

Note: "Precision N" Male and Female Connectors for 7mm precision airline are also available as PCN-2679-NM-AIR-02 and PCN-2679-NF-AIR-02.

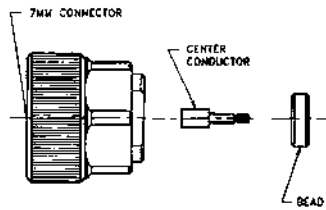

7mm Flange Mount Cable Connectors

Part No.

7MM-2708-00-141-02

Cable Type (RG/U)

402 (.141 Dia. Semi-Rigid)

7MM-2842-00-250-02

401 (.250 Dia. Semi-Rigid)

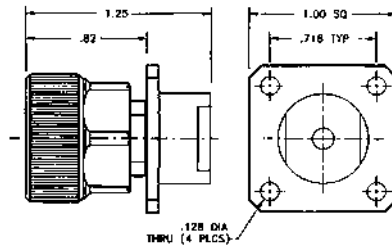

7 mm Flanged Terminal Receptacle

Part No.

7MM-2711-15-TRM-02

Note: Other 7mm cable connectors are available upon request.

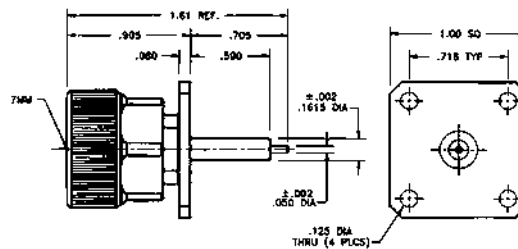

7mm Cable Connectors - Sexed Type

7mm Male

Part No.	Cable Type
7MM-2141-88-SEX-02	.141 Dia.
7MM-2325-88-SEX-02	.325 Dia.

Female Outer Conductor

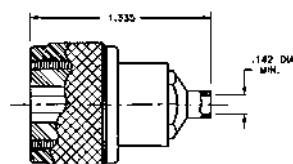

7mm Female

Part No.	Cable Type
7MM-2141-89-SEX-02	.141 Dia.
7MM-2325-89-SEX-02	.325 Dia.

Male Outer Conductor

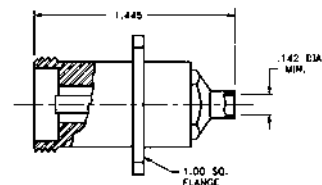

Note: Connectors for 0.325 Dia. cable not shown contact the factory for outline drawing with dimensional details.

Straight Male Cable Plug

Part No.	Cable Dia.
NNN-0141-79-000-02	.141 (RG402)
NNN-0085-79-000-02	.085 (RG405)

See previous page for precision N connectors for precision 7mm airline.

Note: 'Precision N' Male and Female Connectors for 7mm precision airline are also available as PCN-2679-NM-AIR-02 and PCN-2679-NF-AIR-02.

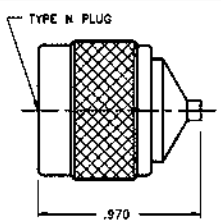

Straight Bulkhead Female Cable Jack

Part No.	Cable Dia.
NNN-0141-83-000-02	.141 (RG402)
NNN-0085-83-000-02	.085 (RG405)

Note: Standard finish is passivated stainless steel with housing plated gold for direct soldering to semi-rigid cable.

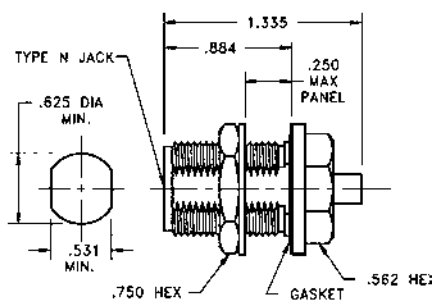

Panel Mount Female Cable Jack

Part No.	Cable Dia.
NNN-0141-84-000-02	.141 (RG402)
NNN-0085-84-000-02	.085 (RG405)

Note: Standard finish is passivated stainless steel with housing plated gold for direct soldering to semi-rigid cable.

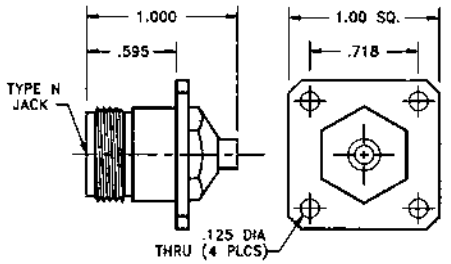

.250 Dia. Semi-Rigid Cable

Male Cable Plug

Part No.
NNN-2250-79-000-02

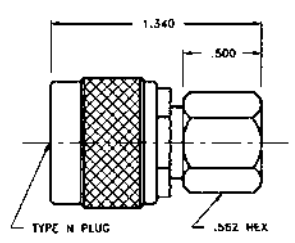

Bulkhead Female Jack

Part No.
NNN-2250-83-000-02

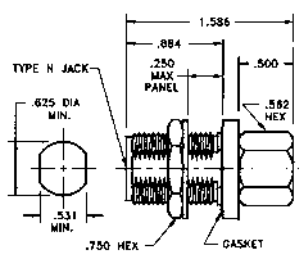

Note: Standard finish is passivated stainless steel. Detail interface dimensions and RG/U cable information can be found in the appendix.

Type N for Flexible Cable / Crimp Attachment Type

Straight Male Cable Plug

Part No.	Cable Type (RG/U)
NNN-3055-55-000-02	55; 142; 223; 400
NNN-3058-55-000-02	58; 141; 303
NNN-3188-55-000-02	174; 179; 188; 316

Note: Standard finish is Passivated Stainless Steel.

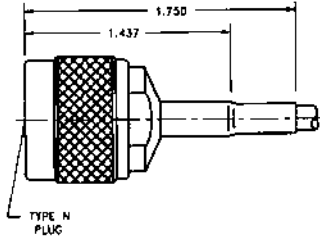

Straight Bulkhead Female Cable Jack

Part No.	Cable Type (RG/U)
NNN-3055-59-000-02	55; 142; 223; 400
NNN-3058-59-000-02	58; 141; 303
NNN-3188-59-000-02	174; 179; 188; 316

Note: Standard finish is Passivated Stainless Steel.

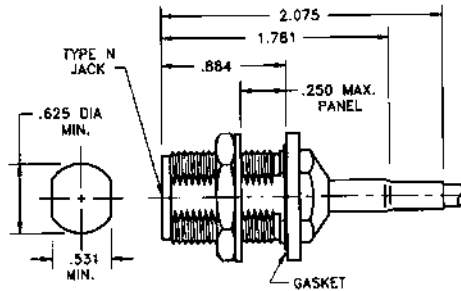

Panel Mount Female Cable Jack

Part No.	Cable Type (RG/U)
NNN-3055-54-000-02	55; 142; 223; 400
NNN-3058-54-000-02	58; 141; 303
NNN-3188-54-000-02	174; 179; 188; 316

Note: Standard finish is Passivated Stainless Steel.

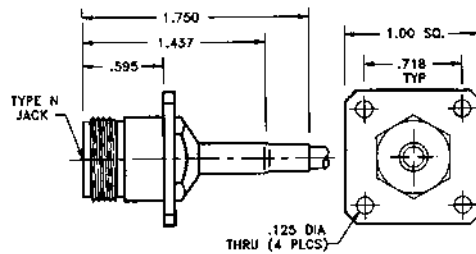

.250 and .500 Dia. Heliax* Cable

Male Cable Plug

Part No.	Cable Type
NNN-2250-79-HEL-10	.250 Dia. Heliax*
NNN-2500-79-HEL-10	.500 Dia. Heliax*

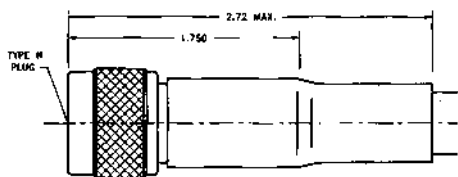

Bulkhead Female Cable Jack

Part No.	Cable Type
NNN-2250-83-HEL-10	.250 Dia. Heliax*
NNN-2500-83-HEL-10	.500 Dia. Heliax*

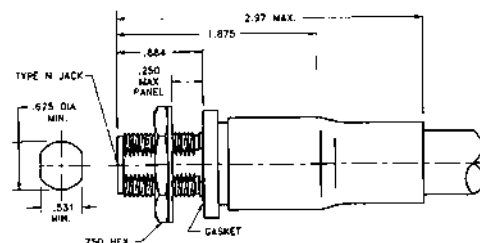

Note: Standard finish is Nickel plated brass. "Heliax" is a registered trademark of Andrew Corporation.

Panel Mount Female Jack - Solder Pot Type

Part No.

NNN-5140-15-POT-02

Note: Standard finish is Passivated Stainless Steel.

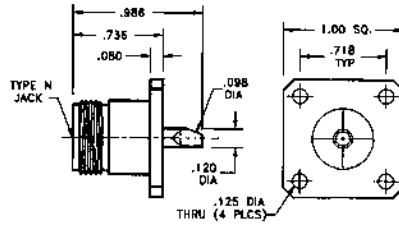

Panel Mount Female Jack - Terminal Type

Part No.

NNN-5110-15-TRM-02

Note: Standard finish is Passivated Stainless Steel.

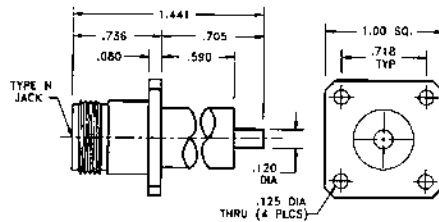

Panel Mount Female Jack - Tab Terminal Type

Part No.

NNN-5130-15-TAB-02

Note: Standard finish is Passivated Stainless Steel.

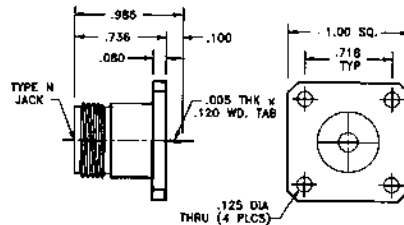

Bulkhead Female Jack - Front Mount

Part No.

NNN-5040-12-POT-02

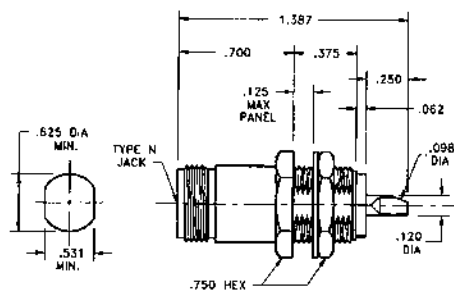

Note: Standard finish is passivated stainless steel. Detail interface dimensions and RG/U cable information can be found in the appendix.

Type N / Panel and Bulkhead Receptacles

Panel Mount Male Plug - Solder Pot Type

Part No.

NNN-5140-14-POT-02

Note: Standard finish is Passivated Stainless Steel.

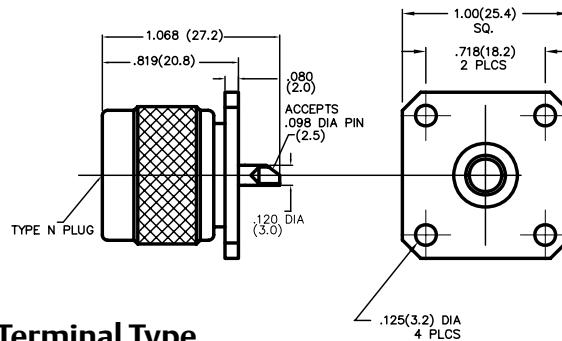

Panel Mount Male Plug - Terminal Type

Part No.

NNN-5110-14-TRM-02

Note: Standard finish is Passivated Stainless Steel.

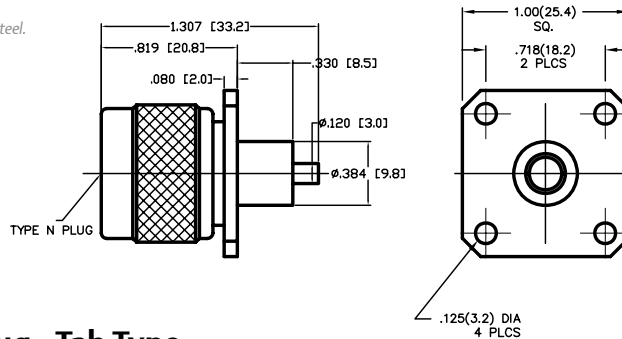

Panel Mount Male Plug - Tab Type

Part No.

NNN-5130-14-TAB-02

Note: Standard finish is Passivated Stainless Steel.

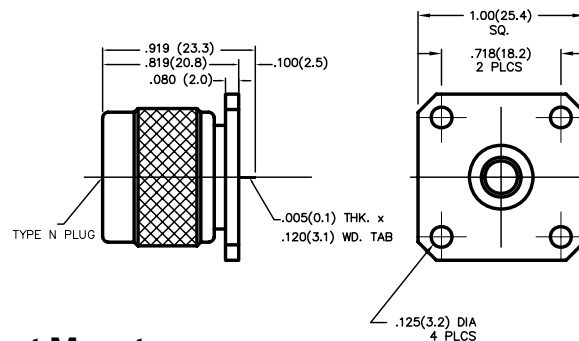

Bulkhead Male Plug - Front Mount

Part No.

NNN-5040-19-POT-02

Note: Standard finish is passivated stainless steel.
Detail interface dimensions can be found in the appendix.

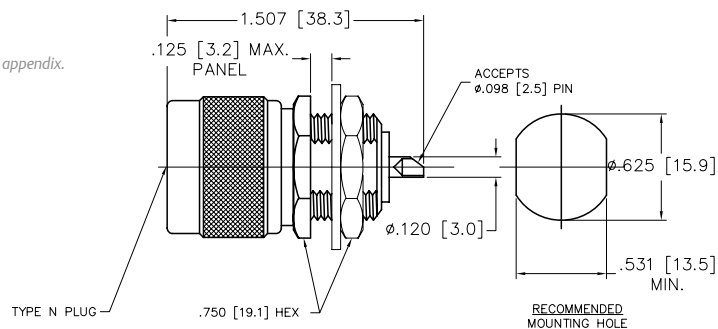

TNC for Semi-Rigid Cable / .085 and .141 Direct Solder Attachment

Straight Male Cable Plug

Part No.	Cable Dia.
TNC-0141-79-000-02	.141 (RG402)
TNC-0085-79-000-02	.085 (RG405)

Note: Standard finish is passivated stainless steel.
Gold plating is provided on housing to allow direct soldering to semi-rigid cable.

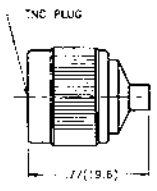

Straight Bulkhead Female Cable Jack

Part No.	Cable Dia.
TNC-0141-83-000-02	.141 (RG402)
TNC-0085-83-000-02	.085 (RG405)

Note: Standard finish is passivated stainless steel.
Gold plating is provided on housing to allow direct soldering to semi-rigid cable.

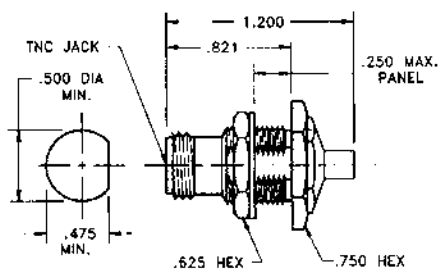

Panel Mount Female Cable Jack

Part No.	Cable Dia.
TNC-0141-84-000-02	.141 (RG402)
TNC-0085-84-000-02	.085 (RG405)

Note: Standard finish is passivated stainless steel.
Gold plating is provided on housing to allow direct soldering to semi-rigid cable.

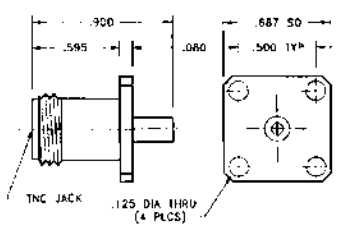

.250 Dia. Semi-Rigid Cable

Male Cable Plug

Part No.
TNC-2250-79-000-02

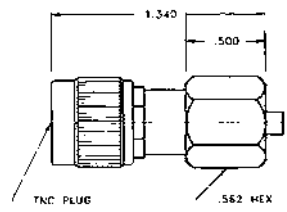

Bulkhead Female Cable Jack

Part No.
TNC-2250-83-000-02

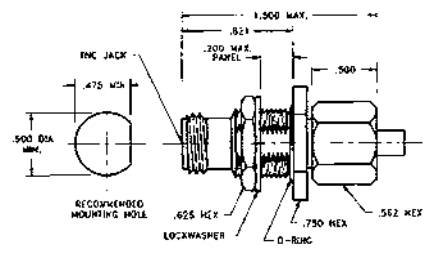

Note: Standard finish is passivated stainless steel. Detail interface dimensions and RG/U cable information can be found in the appendix.

TNC for Flexible Cable / Crimp Attachment Type

Straight Male Cable Plug

Part No.	Cable Type (RG/U)
TNC-3055-55-000-02	55; 142; 223; 400
TNC-3058-55-000-02	58; 141; 303
TNC-3188-55-000-02	174; 179; 188; 316

Note: Standard finish is Passivated Stainless Steel.

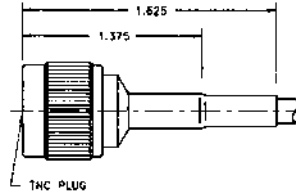

Straight Male Cable Plug

Part No.	Cable Type (RG/U)
TNC-3055-59-000-02	55; 142; 223; 400
TNC-3058-59-000-02	58; 141; 303
TNC-3188-59-000-02	174; 179; 188; 316

Note: Standard finish is Passivated Stainless Steel.

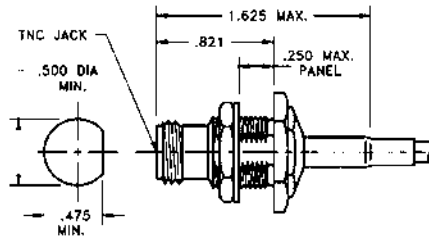

Straight Male Cable Plug

Part No.	Cable Type (RG/U)
TNC-3055-54-000-02	55; 142; 223; 400
TNC-3058-54-000-02	58; 141; 303
TNC-3188-54-000-02	174; 179; 188; 316

Note: Standard finish is Passivated Stainless Steel.

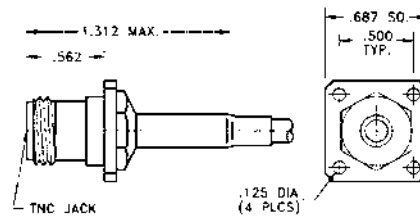

.250 and .500 Dia. Heliax* Cable

Male Cable Plug

Part No.	Cable Type
TNC-2250-79-HEL-10	.250 Dia. Heliax*
TNC-2500-79-HEL-10	.500 Dia. Heliax*

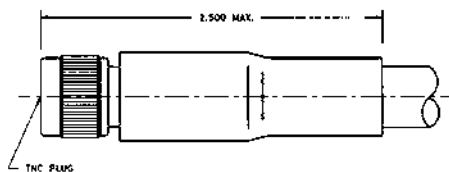

Bulkhead Female Cable Jack

Part No.	Cable Type
TNC-2250-83-HEL-10	.250 Dia. Heliax*
TNC-2500-83-HEL-10	.500 Dia. Heliax*

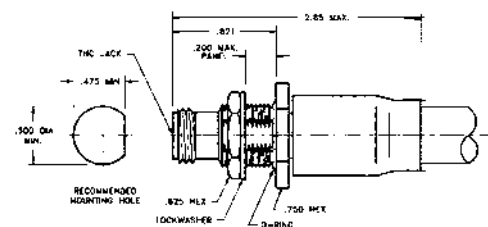

*Note: "Heliax" is a registered trademark of Andrew Corporation.

Panel Mount Female Jack - Solder Pot Type

Part No.

TNC-5740-15-POT-02

Note: Standard finish is passivated stainless steel.

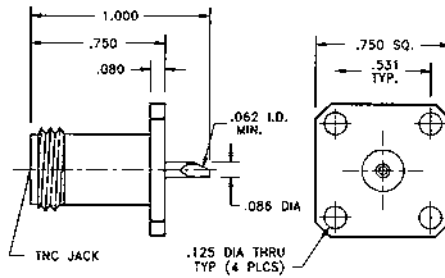

Panel Mount Female Jack - Terminal Type

Part No.

TNC-5710-15-TRM-02

Note: Standard finish is passivated stainless steel.

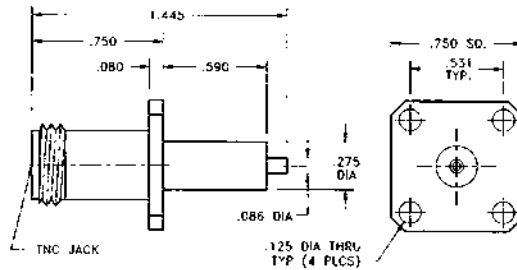

Panel Mount Female Jack - Tab Terminal Type

Part No.

TNC-5730-15-TAB-02

Note: Standard finish is passivated stainless steel.

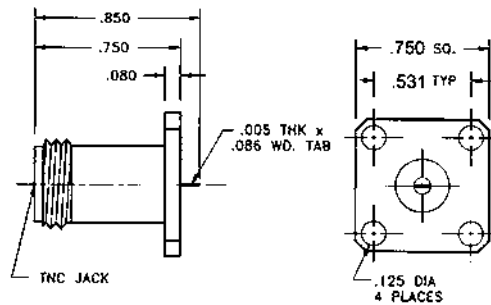

Bulkhead Female Jack - Front Mount

Part No.

TNC-5040-12-POT-02

Note: Standard finish is passivated stainless steel.

Detail interface dimensions can be found in the appendix.

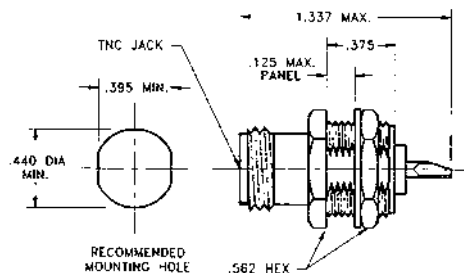

Type N / Panel and Bulkhead Receptacles

Panel Mount Male Plug - Solder Pot Type

Part No.

TNC-5740-14-POT-02

Note: Standard finish is Passivated Stainless Steel.

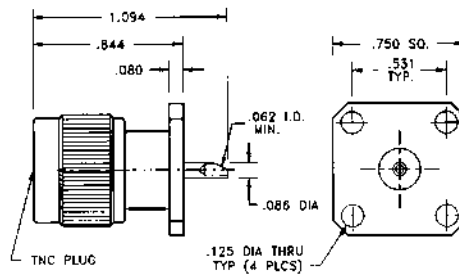

Panel Mount Male Plug - Terminal Type

Part No.

TNC-5710-14-TRM-02

Note: Standard finish is Passivated Stainless Steel.

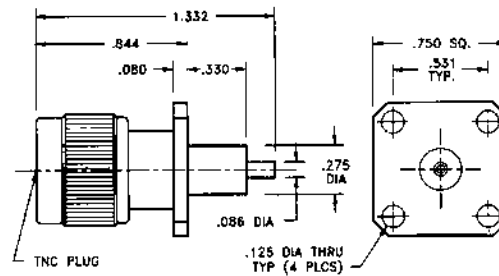

Panel Mount Male Plug - Tab Type

Part No.

TNC-5730-14-TAB-02

Note: Standard finish is Passivated Stainless Steel.

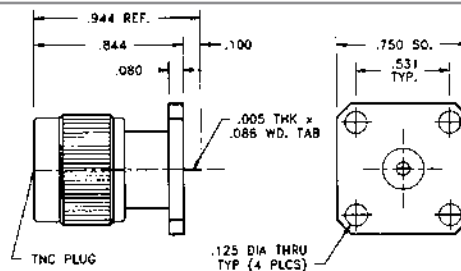

Bulkhead Male Plug - Front Mount

Part No.

TNC-5040-19-POT-02

Note: Standard finish is passivated stainless steel.
Detail interface dimensions and RG/U cable information can be found in the appendix.

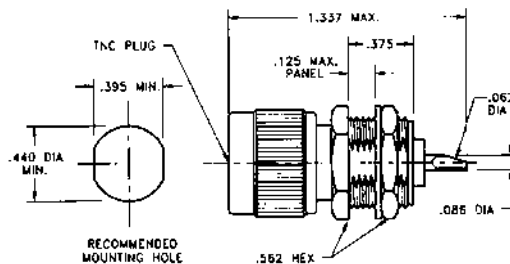

Male Cable Plug

Part No.	Cable Dia.
BNC-0141-79-000-10	.141 (RG402)
BNC-0085-79-000-10	.085 (RG405)

Note: Standard finish is Nickel plated brass.

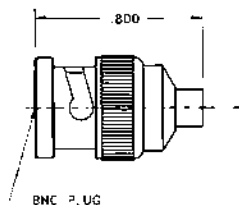

Bulkhead Female Jack

Part No.	Cable Dia.
BNC-0141-83-000-10	.141 (RG402)
BNC-0085-83-000-10	.085 (RG405)

Note: Standard finish is Nickel plated brass.

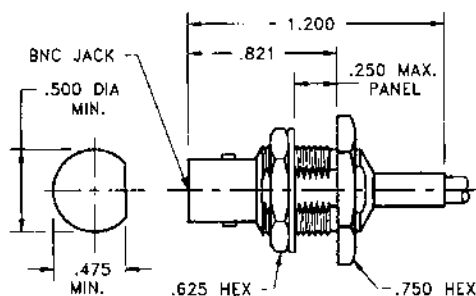

Flanged Mount Cable Jack

Part No.	Cable Dia.
BNC-0141-84-000-10	.141 (RG402)
BNC-0085-84-000-10	.085 (RG405)

Note: Standard finish is Nickel plated brass.

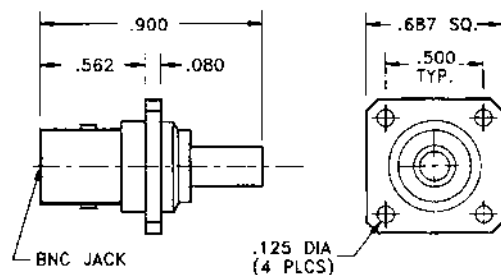

.250 Dia. Semi-Rigid Cable

Male Cable Plug

Part No.
BNC-2250-79-000-10

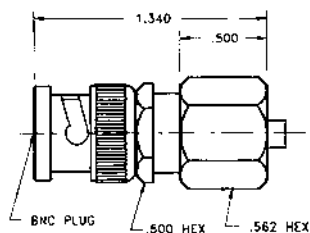

Bulkhead Female Jack

Part No.
BNC-2250-83-000-10

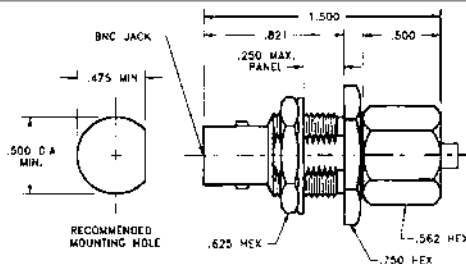

Note: Standard finish is Nickel plated brass. Detail interface information can be found in the appendix.

BNC for Flexible Cable / Crimp Attachment Type

Straight Male Cable Plug

Part No.	Cable Type (RG/U)
BNC-3055-55-000-10	55; 142; 223; 400
BNC-3058-55-000-10	58; 141; 303
BNC-3188-55-000-10	74; 179; 188; 316

Note: Standard finish is Nickel plated brass.

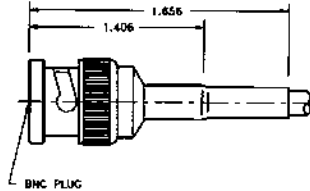

Straight Bulkhead Female Cable Jack

Part No.	Cable Type (RG/U)
BNC-3055-59-000-10	55; 142; 223; 400
BNC-3058-59-000-10	58; 141; 303
BNC-3188-59-000-10	74; 179; 188; 316

Note: Standard finish is Nickel plated brass.

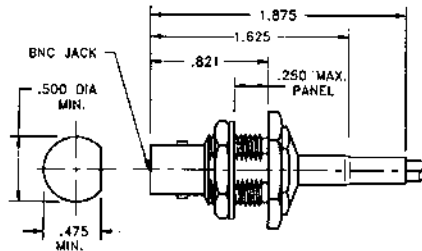

Panel Mount Female Cable Jack

Part No.	Cable Type (RG/U)
BNC-3055-54-000-10	55; 142; 223; 400
BNC-3058-54-000-10	58; 141; 303
BNC-3188-54-000-10	74; 179; 188; 316

Note: Standard finish is Nickel plated brass.

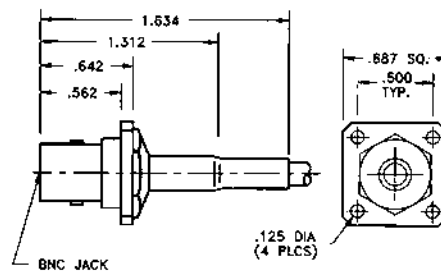

.250 and .500 Dia. Heliax* Cable

Male Cable Plug

Part No.	Cable Type
BNC-2250-79-HEL-10	.250 Dia. Heliax*
BNC-2500-79-HEL-10	.500 Dia. Heliax*

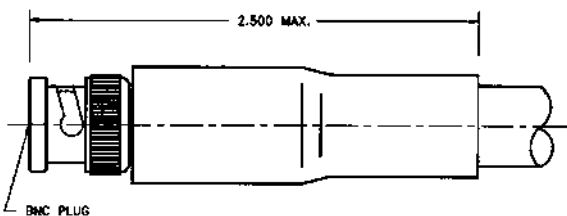

Bulkhead Female Jack

Part No.	Cable Type
BNC-2250-83-HEL-10	.250 Dia. Heliax*
BNC-2500-83-HEL-10	.500 Dia. Heliax*

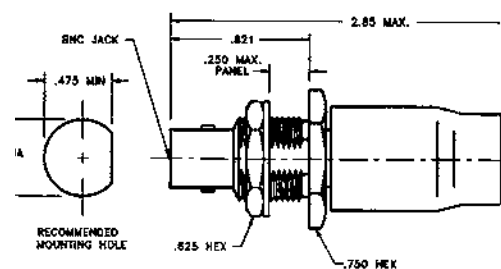

*Note: "Heliax" is a registered trademark of Andrew Corporation. Standard finish is Nickel plated brass.

Panel Mount Female Jack - Solder Pot Type

Part No.
BNC-5740-15-POT-10

Note: Standard finish is Nickel plated brass.

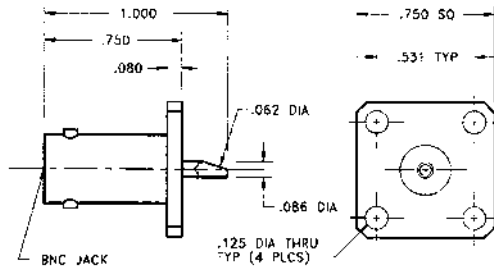

Panel Mount Female Jack - Terminal Type

Part No.
BNC-5710-15-TRM-10

Note: Standard finish is Nickel plated brass.

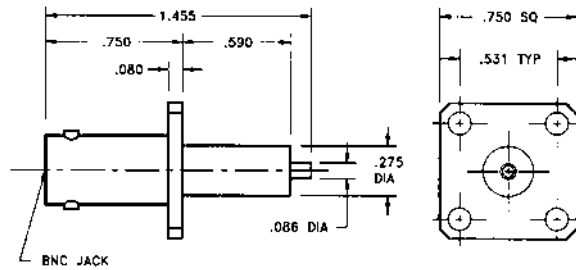

Panel Mount Female Jack - Tab Terminal Type

Part No.
BNC-5730-15-TAB-10

Note: Standard finish is Nickel plated brass.

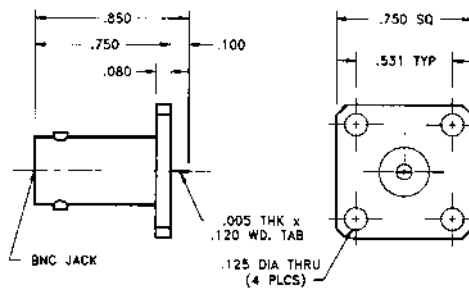

Bulkhead Female Jack - Front Mount

Part No.
BNC-5040-12-POT-10

Note: Standard finish is Nickel plated brass.
Detail interface dimensional information can be found in the appendix.

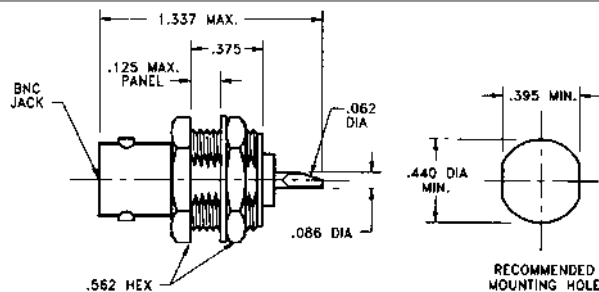

BNC / Panel and Bulkhead Receptacles

Panel Mount Male Plug - Solder Pot Type

Part No.

BNC-5740-14-POT-10

Note: Standard finish is Nickel plated brass.

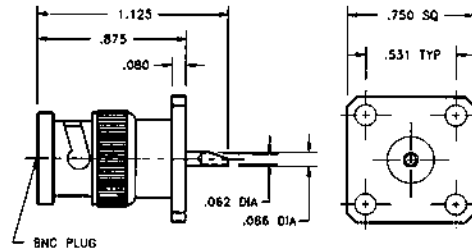

Panel Mount Male Plug - Terminal Type

Part No.

BNC-5710-14-TRM-10

Note: Standard finish is Nickel plated brass.

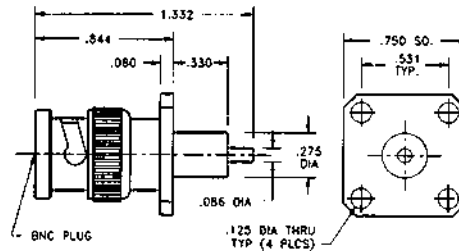

Panel Mount Male Plug - Tab Type

Part No.

BNC-5730-14-TAB-10

Note: Standard finish is Nickel plated brass.

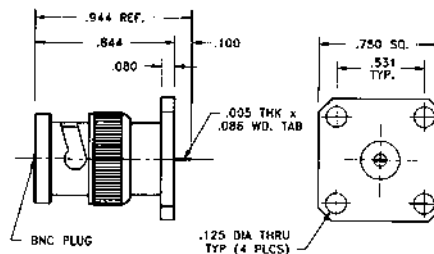

Bulkhead Male Plug - Front Mount

Part No.

BNC-5040-19-POT-10

Note: Standard finish is Nickel plated brass.

Detail interface dimensions and RG/U cable information can be found in the appendix.

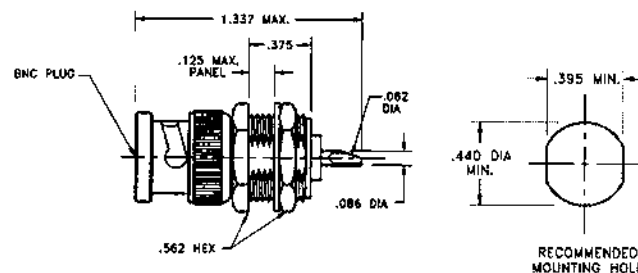

QPL Approved Products

Qualified Parts List Products	178
Attenuators (QPL).....	179
Attenuators – Fixed Coaxial	180-184
Attenuators – TNC Type – Fixed Coaxial	185
SMA Connectors for Flexible Cable	186-187
SMA Connectors Panel Mount Type	187-188
SMA Connectors for Semi-Rigid Cable	189-190
SMA Printed Circuit Mount Connectors	191
Terminations (Dummy Loads).....	192
Definition of Categories.....	193

(DESC) Approved Products

SMA Connectors	
Semi-Rigid Cable	194
Semi-Rigid & Flexible Cable	195
BMA Blind Mate Connectors	196
Between Series Adapters	197
Type N to SMA Adapters	198

Tools

Tool Kits for Connector Assemblies.....	199
---	-----

3	Attenuators
----------	--------------------

31	Terminations
-----------	---------------------

58	DC Blocks
-----------	------------------

61	Couplers
-----------	-----------------

73	Power Dividers
-----------	-----------------------

81	Equalizers
-----------	-------------------

85	Phase Shifters
-----------	-----------------------

87	Between Series Adapters
-----------	--------------------------------

116	In-Series Adapters
------------	---------------------------

127	Connectors
------------	-------------------

177	QPL Approved Products & Tools for Assembly
------------	---

200	Appendix
------------	-----------------

209	Index
------------	--------------

Qualified Parts List Products

**MIL-DTL-3933
Attenuators**

**MIL-PRF-39012
Connectors**

**MIL-DTL-39030
Terminations**

The Qualified Parts Listing (QPL) is a list compiled by the U.S. Government of products that are used by the Government and are covered by military specifications. The purpose of the list is to provide a simple way of accessing identification of those products and the vendors that have been qualified to manufacture them such that procurement may be easily accomplished. All products listed on a particular QPL have been tested and have qualified to the requirements for that product, as specified in the latest effective issue of the applicable military specification. By using a part that appears on the QPL list, a user is assured that the part will meet or exceed the performance specifications set forth in the MIL Specification as a minimum standard of performance.

Emerson Network Power Connectivity Solutions is a leading manufacturer of Midwest Microwave product line of Attenuators, Terminations, Adapters, and Connectors and is the originator of the “Minipad” Attenuator around which the military specifications were written. The company’s technical leadership and extensive experience combined with its broad product capability provide the user with a reliable, high quality source for high performance QPL coaxial microwave components.

QPL Products

Attenuators	0-40 dB	DC-18.0 GHz	MIL-DTL-3933
Terminations		DC-18.0 GHz	MIL-DTL-39030
SMA Connectors			MIL-PRF-39012
Adapters - Between Series			

DESC Approved Products

SMA Connectors
SSMA Connectors
BMA Blind Mate Connectors
Adapters - Between Series

The Defense Electronics Supply Center (DESC) is a government agency whose name has been recently changed into Defense Logistics Agency (DLA), however all existing DESC drawings and specifications did not change and are still valid. DLA continuously reviews products that are being used in military systems that are not covered by a military QPL with the purpose of approving suppliers for those products. Midwest Microwave product line has consistently been selected by DESC as an approved supplier for many of these products. The DESC approved product section lists the military numbers as well as the Midwest Microwave part numbers.

MIL-DTL-3933 Qualified (QPL)

- Non-Screened and Screened Units Available
- 100% Tested
- Military Applications

Midwest Microwave's QPL Attenuator products were designed, tested and have been qualified to the stringent requirements of the latest effective issue of the applicable military specifications. By selecting a part that appears on a QPL list, a user is assured that the part will meet or exceed the performance specifications set forth in the MIL Specification as a minimum standard of performance.



MIL Part Slash No. Group	Description	Frequency (GHz)	Attenuation (dB)
MIL-DTL-3933/25	SMA Subminiature - Male/Female	DC - 4.0, DC - 12.4, DC - 18.0	0 - 40
MIL-DTL-3933/14	SMA Miniature - Male/Female	DC - 12.4	1 - 40
MIL-DTL-3933/16	SMA Miniature - Male/Female	DC - 18.0	0 - 40
MIL-DTL-3933/17	TNC - Male/Female	DC - 4.5, DC - 18.0	1-8, 10, 12, 15, 20, 25, 30, & 40

Screened Attenuators per Table I of MIL-DTL-3933

Screening Tests:

Thermal Shock

Pre-Conditioning Electrical:

DC Resistance

VSWR

Attenuation

Conditioning

Post-Conditioning Electrical:

DC Resistance

VSWR

Attenuation

Radiographic Inspection

Non-Screened Attenuators per Table IV of MIL-DTL-3933

Group A Inspection Tests

Visual & Mechanical Examination

VSWR

Attenuation

Stability of Attenuation:

After Peak Power

*Note: All Screened Attenuators are tested 100% per Table IV and I of MIL-DTL-3933.
All Non-Screened Attenuators are tested 100% per Table IV of MIL-DTL-3933.*

Attenuators – Fixed Coaxial

MIL-DTL-3933/14

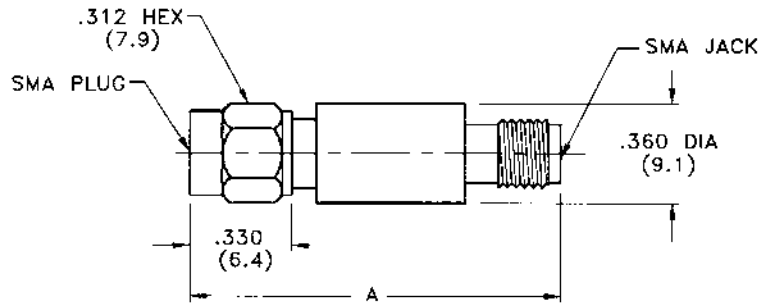

Military Part No.	Midwest Part No.	Dimension A inches (mm) (max.)	Attenuation Value (dB) (nom.)	Frequency Range (GHz)	Commercial Alternate
-01	M3933/14-01N	1.20 (30.5)	3.0	DC - 12.4	ATT-0205-03-SMA-02
-02	M3933/14-02N	1.20 (30.5)	6.0	DC - 12.4	ATT-0205-06-SMA-02
-03	M3933/14-03N	1.20 (30.5)	10.0	DC - 12.4	ATT-0205-10-SMA-02
-04	M3933/14-04N	1.20 (30.5)	20.0	DC - 12.4	ATT-0205-20-SMA-02
-05	M3933/14-05N	1.20 (30.5)	15.0	DC - 12.4	ATT-0205-15-SMA-02
-06	M3933/14-06N	1.20 (30.5)	1.0	DC - 12.4	ATT-0205-01-SMA-02
-07	M3933/14-07N	1.20 (30.5)	2.0	DC - 12.4	ATT-0205-02-SMA-02
-08	M3933/14-08N	1.20 (30.5)	4.0	DC - 12.4	ATT-0205-04-SMA-02
-09	M3933/14-09N	1.20 (30.5)	5.0	DC - 12.4	ATT-0205-05-SMA-02
-10	M3933/14-10N	1.20 (30.5)	7.0	DC - 12.4	ATT-0205-07-SMA-02
-11	M3933/14-11N	1.20 (30.5)	8.0	DC - 12.4	ATT-0205-08-SMA-02
-12	M3933/14-12N	1.20 (30.5)	9.0	DC - 12.4	ATT-0205-09-SMA-02
-13	M3933/14-13N	1.50 (38.1)	30.0	DC - 12.4	ATT-0205-30-SMA-02
-14	M3933/14-14N	1.50 (38.1)	40.0	DC - 12.4	ATT-0205-40-SMA-02
-15	M3933/14-15N	1.50 (38.1)	60.0	DC - 12.4	ATT-0205-60-SMA-02
-17	M3933/14-17N	1.50 (38.1)	28.0	DC - 12.4	ATT-0205-28-SMA-02
-18	M3933/14-18N	1.20 (30.5)	16.0	DC - 12.4	ATT-0205-16-SMA-02
-19	M3933/14-19N	1.20 (30.5)	14.0	DC - 12.4	ATT-0205-14-SMA-02
-20	M3933/14-20N	1.20 (30.5)	13.0	DC - 12.4	ATT-0205-13-SMA-02
-21	M3933/14-21N	1.20 (30.5)	12.0	DC - 12.4	ATT-0205-12-SMA-02
-22	M3933/14-22N	1.20 (30.5)	11.0	DC - 12.4	ATT-0205-11-SMA-02
-23	M3933/14-23N	1.20 (30.5)	1.5	DC - 12.4	ATT-0205-72-SMA-02
-24	M3933/14-24N	1.50 (38.1)	31.0	DC - 12.4	ATT-0205-31-SMA-02

Notes:

1. Midwest Microwave part number reflects a non-screened part. For a screened part, change suffix "N" to "S".
2. See Appendix for description of connector interface.

MIL-DTL-3933/16

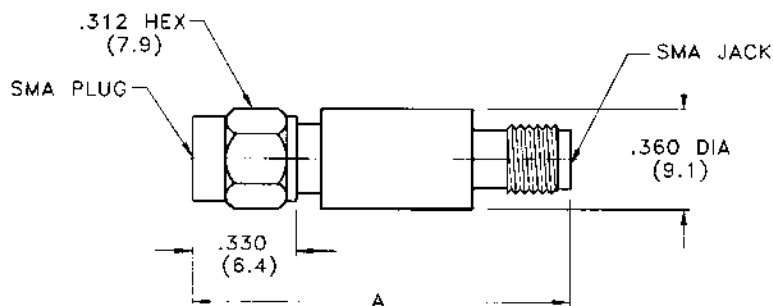

Military Part No.	Midwest Part No.	Dimension A inches (mm) (max.)	Attenuation Value (dB) (nom.)	Frequency Range (GHz)	Commercial Alternate
-01	M3933/16-01N	1.20 (30.5)	3.0	DC - 18.0	ATT-0263-03-SMA-02
-02	M3933/16-02N	1.20 (30.5)	6.0	DC - 18.0	ATT-0263-06-SMA-02
-03	M3933/16-03N	1.20 (30.5)	10.0	DC - 18.0	ATT-0263-10-SMA-02
-04	M3933/16-04N	1.20 (30.5)	20.0	DC - 18.0	ATT-0263-20-SMA-02
-05	M3933/16-05N	1.20 (30.5)	1.0	DC - 18.0	ATT-0263-01-SMA-02
-06	M3933/16-06N	1.20 (30.5)	2.0	DC - 18.0	ATT-0263-02-SMA-02
-07	M3933/16-07N	1.20 (30.5)	4.0	DC - 18.0	ATT-0263-04-SMA-02
-08	M3933/16-08N	1.20 (30.5)	5.0	DC - 18.0	ATT-0263-05-SMA-02
-09	M3933/16-09N	1.20 (30.5)	7.0	DC - 18.0	ATT-0263-07-SMA-02
-10	M3933/16-10N	1.20 (30.5)	8.0	DC - 18.0	ATT-0263-08-SMA-02
-11	M3933/16-11N	1.20 (30.5)	9.0	DC - 18.0	ATT-0263-09-SMA-02
-12	M3933/16-12N	1.50 (38.1)	30.0	DC - 18.0	ATT-0263-30-SMA-02
-13	M3933/16-13N	1.49 (37.8)	40.0	DC - 18.0	ATT-0263-40-SMA-02
-16	M3933/16-16N	1.20 (30.5)	0	DC - 18.0	ATT-0263-00-SMA-02
-17	M3933/16-17N	1.20 (30.5)	0.5	DC - 18.0	ATT-0263-70-SMA-02
-18	M3933/16-18N	1.20 (30.5)	1.5	DC - 18.0	ATT-0263-71-SMA-02
-19	M3933/16-19N	1.20 (30.5)	2.5	DC - 18.0	ATT-0263-72-SMA-02
-20	M3933/16-20N	1.20 (30.5)	3.5	DC - 18.0	ATT-0263-73-SMA-02
-21	M3933/16-21N	1.20 (30.5)	4.5	DC - 18.0	ATT-0263-74-SMA-02
-22	M3933/16-22N	1.20 (30.0)	5.5	DC - 18.0	ATT-0263-75-SMA-02
-23	M3933/16-23N	1.20 (30.5)	6.5	DC - 18.0	ATT-0263-76-SMA-02
-24	M3933/16-24N	1.20 (30.5)	7.5	DC - 18.0	ATT-0263-77-SMA-02
-25	M3933/16-25N	1.20 (30.5)	8.5	DC - 18.0	ATT-0263-78-SMA-02
-26	M3933/16-26N	1.20 (30.5)	9.5	DC - 18.0	ATT-0263-79-SMA-02
-27	M3933/16-27N	1.20 (30.5)	10.5	DC - 18.0	ATT-0263-80-SMA-02
-28	M3933/16-28N	1.20 (30.5)	11.0	DC - 18.0	ATT-0263-11-SMA-02

Attenuators – Fixed Coaxial

MIL-DTL-3933/16

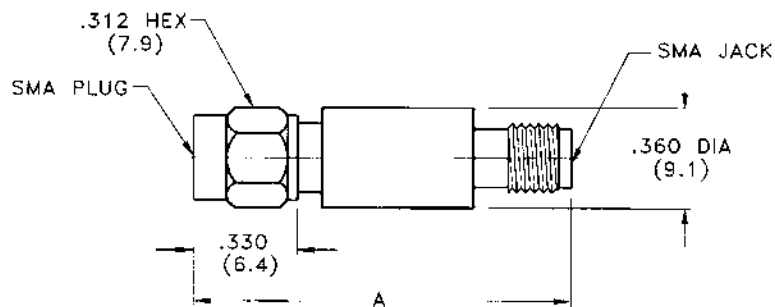

Military Part No.	Midwest Part No.	Dimension A inches (mm) (max.)	Attenuation Value (dB) (nom.)	Frequency Range (GHz)	Commercial Alternate
-29	M3933/16-29N	1.20 (30.5)	11.5	DC - 18.0	ATT-0263-81-SMA-02
-30	M3933/16-30N	1.20 (30.5)	12.0	DC - 18.0	ATT-0263-12-SMA-02
-31	M3933/16-31N	1.20 (30.5)	12.5	DC - 18.0	ATT-0263-82-SMA-02
-32	M3933/16-32N	1.20 (30.5)	13.0	DC - 18.0	ATT-0263-13-SMA-02
-33	M3933/16-33N	1.20 (30.5)	13.5	DC - 18.0	ATT-0263-83-SMA-02
-34	M3933/16-34N	1.20 (30.5)	14.0	DC - 18.0	ATT-0263-14-SMA-02
-35	M3933/16-35N	1.20 (30.5)	14.5	DC - 18.0	ATT-0263-84-SMA-02
-36	M3933/16-36N	1.20 (30.0)	15.0	DC - 18.0	ATT-0263-15-SMA-02
-37	M3933/16-37N	1.20 (30.5)	15.5	DC - 18.0	ATT-0263-85-SMA-02
-38	M3933/16-38N	1.20 (30.5)	16.0	DC - 18.0	ATT-0263-16-SMA-02
-39	M3933/16-39N	1.20 (30.5)	16.5	DC - 18.0	ATT-0263-86-SMA-02
-40	M3933/16-40N	1.20 (30.5)	17.0	DC - 18.0	ATT-0263-17-SMA-02
-41	M3933/16-41N	1.20 (30.5)	17.5	DC - 18.0	ATT-0263-87-SMA-02
-42	M3933/16-42N	1.20 (30.5)	18.0	DC - 18.0	ATT-0263-18-SMA-02
-43	M3933/16-43N	1.20 (30.5)	18.5	DC - 18.0	ATT-0263-88-SMA-02
-44	M3933/16-44N	1.20 (30.5)	19.0	DC - 18.0	ATT-0263-19-SMA-02
-45	M3933/16-45N	1.20 (30.5)	19.5	DC - 18.0	ATT-0263-89-SMA-02
-46	M3933/16-46N	1.20 (30.5)	20.5	DC - 18.0	ATT-0263-90-SMA-02
-47	M3933/16-47N	1.20 (30.5)	21.0	DC - 18.0	ATT-0263-21-SMA-02
-48	M3933/16-48N	1.20 (30.5)	21.5	DC - 18.0	ATT-0263-91-SMA-02
-49	M3933/16-49N	1.20 (30.5)	22.0	DC - 18.0	ATT-0263-22-SMA-02
-50	M3933/16-50N	1.20 (30.5)	22.5	DC - 18.0	ATT-0263-92-SMA-02
-51	M3933/16-51N	1.20 (30.5)	23.0	DC - 18.0	ATT-0263-23-SMA-02
-52	M3933/16-52N	1.20 (30.5)	23.5	DC - 18.0	ATT-0263-93-SMA-02
-53	M3933/16-53N	1.20 (30.5)	24.0	DC - 18.0	ATT-0263-24-SMA-02
-54	M3933/16-54N	1.20 (30.5)	24.0	DC - 18.0	ATT-0263-94-SMA-02
-55	M3933/16-55N	1.20 (30.5)	25.0	DC - 18.0	ATT-0263-25-SMA-02
-56	M3933/16-56N	1.20 (30.5)	28.0	DC - 18.0	ATT-0263-28-SMA-02
-57	M3933/16-57N	1.49 (37.8)	32.0	DC - 18.0	ATT-0263-32-SMA-02
-58	M3933/16-58N	1.49 (37.8)	36.0	DC - 18.0	ATT-0263-36-SMA-02

Notes:

1. Midwest Microwave part number reflects a non-screened part. For a screened part, change suffix "N" to "S".
2. See Appendix for description of connector interface.

MIL-DTL-3933/25

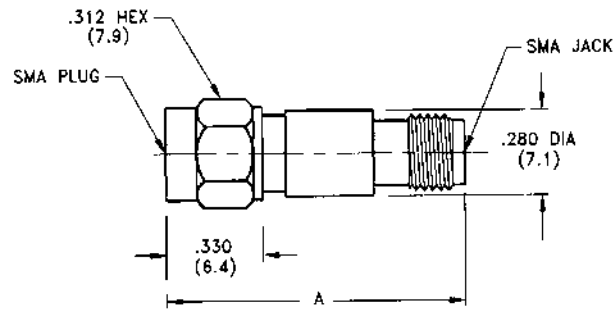

Military Part No.	Midwest Part No.	Dimension A inches (mm) (max.)	Attenuation Value (dB) (nom.)	Frequency Range (GHz)	Commercial Alternate
-01	M3933/25-01N	0.86 (21.9)	1.0	DC - 2.0	ATT-0294-01-SMA-02
-02	M3933/25-02N	0.86 (21.9)	2.0	DC - 2.0	ATT-0294-02-SMA-02
-03	M3933/25-03N	0.86 (21.9)	3.0	DC - 2.0	ATT-0294-03-SMA-02
-04	M3933/25-04N	0.86 (21.9)	4.0	DC - 2.0	ATT-0294-04-SMA-02
-05	M3933/25-05N	0.86 (21.9)	5.0	DC - 2.0	ATT-0294-05-SMA-02
-06	M3933/25-06N	0.86 (21.9)	6.0	DC - 2.0	ATT-0294-06-SMA-02
-07	M3933/25-07N	0.86 (21.9)	7.0	DC - 2.0	ATT-0294-07-SMA-02
-08	M3933/25-08N	0.86 (21.9)	8.0	DC - 2.0	ATT-0294-08-SMA-02
-09	M3933/25-09N	0.86 (21.9)	9.0	DC - 2.0	ATT-0294-09-SMA-02
-10	M3933/25-10N	0.86 (21.9)	10.0	DC - 2.0	ATT-0294-10-SMA-02
-11	M3933/25-11N	0.86 (21.9)	11.0	DC - 2.0	ATT-0294-11-SMA-02
-12	M3933/25-12N	0.86 (21.9)	12.0	DC - 2.0	ATT-0294-12-SMA-02
-13	M3933/25-13N	1.02 (26.0)	13.0	DC - 2.0	ATT-0294-13-SMA-02
-14	M3933/25-14N	1.02 (26.0)	14.0	DC - 2.0	ATT-0294-14-SMA-02
-15	M3933/25-15N	1.02 (26.0)	15.0	DC - 2.0	ATT-0294-15-SMA-02
-16	M3933/25-16N	1.02 (26.0)	16.0	DC - 2.0	ATT-0294-16-SMA-02
-17	M3933/25-17N	1.02 (26.0)	17.0	DC - 2.0	ATT-0294-17-SMA-02
-18	M3933/25-18N	1.02 (26.0)	18.0	DC - 2.0	ATT-0294-18-SMA-02
-19	M3933/25-19N	1.02 (26.0)	19.0	DC - 2.0	ATT-0294-19-SMA-02
-20	M3933/25-20N	1.02 (26.0)	20.0	DC - 2.0	ATT-0294-20-SMA-02
-21	M3933/25-21N	1.02 (26.0)	21.0	DC - 2.0	ATT-0294-21-SMA-02
-22	M3933/25-22N	1.02 (26.0)	22.0	DC - 2.0	ATT-0294-22-SMA-02
-23	M3933/25-23N	1.02 (26.0)	23.0	DC - 2.0	ATT-0294-23-SMA-02
-24	M3933/25-24N	1.02 (26.0)	24.0	DC - 2.0	ATT-0294-24-SMA-02
-25	M3933/25-25N	1.02 (26.0)	25.0	DC - 2.0	ATT-0294-25-SMA-02
-26	M3933/25-26N	1.02 (26.0)	30.0	DC - 2.0	ATT-0294-30-SMA-02
-27	M3933/25-27N	0.86 (21.9)	1.0	DC - 12.4	ATT-0291-01-SMA-02
-28	M3933/25-28N	0.86 (21.9)	2.0	DC - 12.4	ATT-0291-02-SMA-02
-29	M3933/25-29N	0.86 (21.9)	3.0	DC - 12.4	ATT-0291-03-SMA-02
-30	M3933/25-30N	0.86 (21.9)	4.0	DC - 12.4	ATT-0291-04-SMA-02
-31	M3933/25-31N	0.86 (21.9)	5.0	DC - 12.4	ATT-0291-05-SMA-02
-32	M3933/25-32N	0.86 (21.9)	6.0	DC - 12.4	ATT-0291-06-SMA-02
-33	M3933/25-33N	0.86 (21.9)	7.0	DC - 12.4	ATT-0291-07-SMA-02
-34	M3933/25-34N	0.86 (21.9)	8.0	DC - 12.4	ATT-0291-08-SMA-02
-35	M3933/25-35N	0.86 (21.9)	9.0	DC - 12.4	ATT-0291-09-SMA-02

Notes:

1. Midwest Microwave part number reflects a non-screened part. For a screened part, change suffix "N" to "S".
2. See Appendix for description of connector interface.

Attenuators – Fixed Coaxial

MIL-DTL-3933/25 (Continued from previous page)

Military Part No.	Midwest Part No.	Dimension A inches (mm) (max.)	Attenuation Value (dB) (nom.)	Frequency Range (GHz)	Commercial Alternate
-36	M3933/25-36N	0.86 (21.9)	10.0	DC - 12.4	ATT-0291-10-SMA-02
-37	M3933/25-37N	0.86 (21.9)	11.0	DC - 12.4	ATT-0291-11-SMA-02
-38	M3933/25-38N	0.86 (21.9)	12.0	DC - 12.4	ATT-0291-12-SMA-02
-39	M3933/25-39N	0.94 (23.9)	13.0	DC - 12.4	ATT-0291-13-SMA-02
-40	M3933/25-40N	0.94 (23.9)	14.0	DC - 12.4	ATT-0291-14-SMA-02
-41	M3933/25-41N	0.94 (23.9)	15.0	DC - 12.4	ATT-0291-15-SMA-02
-42	M3933/25-42N	0.94 (23.9)	16.0	DC - 12.4	ATT-0291-16-SMA-02
-43	M3933/25-43N	0.94 (23.9)	17.0	DC - 12.4	ATT-0291-17-SMA-02
-44	M3933/25-44N	0.94 (23.9)	18.0	DC - 12.4	ATT-0291-18-SMA-02
-45	M3933/25-45N	0.94 (23.9)	19.0	DC - 12.4	ATT-0291-19-SMA-02
-46	M3933/25-46N	1.02 (26.0)	20.0	DC - 12.4	ATT-0291-20-SMA-02
-47	M3933/25-47N	1.02 (26.0)	21.0	DC - 12.4	ATT-0291-21-SMA-02
-48	M3933/25-48N	1.02 (26.0)	22.0	DC - 12.4	ATT-0291-22-SMA-02
-49	M3933/25-49N	1.02 (26.0)	23.0	DC - 12.4	ATT-0291-23-SMA-02
-50	M3933/25-50N	1.02 (26.0)	24.0	DC - 12.4	ATT-0291-24-SMA-02
-51	M3933/25-51N	1.02 (26.0)	25.0	DC - 12.4	ATT-0291-25-SMA-02
-52	M3933/25-52N	1.02 (26.0)	30.0	DC - 12.4	ATT-0291-30-SMA-02
-53	M3933/25-53N	1.02 (26.0)	35.0	DC - 12.4	ATT-0291-35-SMA-02
-54	M3933/25-54N	1.02 (26.0)	40.0	DC - 12.4	ATT-0291-40-SMA-02
-58	M3933/25-58N	0.86 (21.9)	0	DC - 18.0	ATT-0290-00-SMA-02
-59	M3933/25-59N	0.86 (21.9)	0.5	DC - 18.0	ATT-0290-70-SMA-02
-60	M3933/25-60N	0.86 (21.9)	1.0	DC - 18.0	ATT-0290-01-SMA-02
-61	M3933/25-61N	0.86 (21.9)	1.5	DC - 18.0	ATT-0290-71-SMA-02
-62	M3933/25-62N	0.86 (21.9)	2.0	DC - 18.0	ATT-0290-02-SMA-02
-63	M3933/25-63N	0.86 (21.9)	2.0	DC - 18.0	ATT-0290-72-SMA-02
-64	M3933/25-64N	0.86 (21.9)	3.0	DC - 18.0	ATT-0290-03-SMA-02
-65	M3933/25-65N	0.86 (21.9)	3.5	DC - 18.0	ATT-0290-73-SMA-02
-66	M3933/25-66N	0.86 (21.9)	4.0	DC - 18.0	ATT-0290-04-SMA-02
-67	M3933/25-67N	0.86 (21.9)	4.5	DC - 18.0	ATT-0290-74-SMA-02
-68	M3933/25-68N	0.86 (21.9)	5.0	DC - 18.0	ATT-0290-05-SMA-02
-69	M3933/25-69N	0.86 (21.9)	5.5	DC - 18.0	ATT-0290-75-SMA-02
-70	M3933/25-70N	0.86 (21.9)	6.0	DC - 18.0	ATT-0290-06-SMA-02
-71	M3933/25-71N	0.86 (21.9)	6.5	DC - 18.0	ATT-0290-76-SMA-02
-72	M3933/25-72N	0.86 (21.9)	7.0	DC - 18.0	ATT-0290-07-SMA-02
-73	M3933/25-73N	0.86 (21.9)	7.5	DC - 18.0	ATT-0290-77-SMA-02
-74	M3933/25-74N	0.86 (21.9)	8.0	DC - 18.0	ATT-0290-08-SMA-02
-75	M3933/25-75N	0.86 (21.9)	8.5	DC - 18.0	ATT-0290-78-SMA-02
-76	M3933/25-76N	0.86 (21.9)	9.0	DC - 18.0	ATT-0290-09-SMA-02
-77	M3933/25-77N	0.86 (21.9)	9.5	DC - 18.0	ATT-0290-79-SMA-02
-78	M3933/25-78N	0.86 (21.9)	10.0	DC - 18.0	ATT-0290-10-SMA-02
-79	M3933/25-79N	0.86 (21.9)	11.0	DC - 18.0	ATT-0290-11-SMA-02
-80	M3933/25-80N	0.86 (21.9)	12.0	DC - 18.0	ATT-0290-12-SMA-02
-81	M3933/25-81N	0.94 (23.9)	13.0	DC - 18.0	ATT-0290-13-SMA-02
-82	M3933/25-82N	0.94 (23.9)	14.0	DC - 18.0	ATT-0290-14-SMA-02
-83	M3933/25-83N	1.02 (26.0)	15.0	DC - 18.0	ATT-0290-15-SMA-02
-84	M3933/25-84N	1.02 (26.0)	16.0	DC - 18.0	ATT-0290-16-SMA-02
-85	M3933/25-85N	1.02 (26.0)	17.0	DC - 18.0	ATT-0290-17-SMA-02
-86	M3933/25-86N	1.02 (26.0)	18.0	DC - 18.0	ATT-0290-18-SMA-02
-87	M3933/25-87N	1.02 (26.0)	19.0	DC - 18.0	ATT-0290-19-SMA-02
-88	M3933/25-88N	1.02 (26.0)	20.0	DC - 18.0	ATT-0290-20-SMA-02
-89	M3933/25-89N	1.02 (26.0)	25.0	DC - 18.0	ATT-0290-25-SMA-02
-90	M3933/25-90N	1.02 (26.0)	30.0	DC - 18.0	ATT-0290-30-SMA-02
-91	M3933/25-91N	1.02 (26.0)	35.0	DC - 18.0	ATT-0290-35-SMA-02
-92	M3933/25-92N	1.02 (26.0)	40.0	DC - 18.0	ATT-0290-40-SMA-02

Notes:

1. Midwest Microwave part number reflects a non-screened part. For a screened part, change suffix "N" to "S".
2. See Appendix for description of connector interface.

MIL-DTL-3933/17

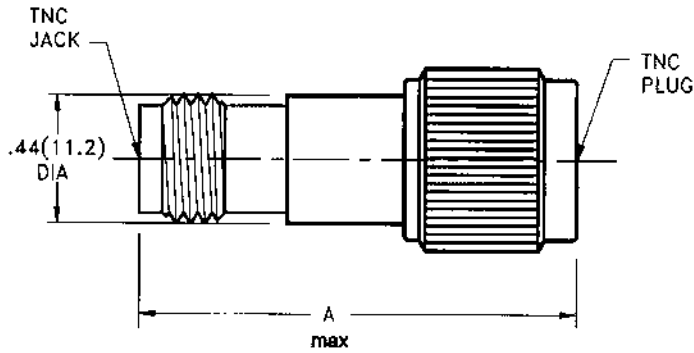

Military Part No.	Midwest Part No.	Dimension A inches (mm) (max.)	Attenuation Value (dB) (nom.)	Frequency Range (GHz)	Commercial Alternate
-01	M3933/17-01N	1.57 (39.9)	1.0	DC - 4.5	ATT-0224-01-TNC-02
-02	M3933/17-02N	1.57 (39.9)	2.0	DC - 4.5	ATT-0224-02-TNC-02
-03	M3933/17-03N	1.57 (39.9)	3.0	DC - 4.5	ATT-0224-03-TNC-02
-04	M3933/17-04N	1.57 (39.9)	4.0	DC - 4.5	ATT-0224-04-TNC-02
-05	M3933/17-05N	1.57 (39.9)	5.0	DC - 4.5	ATT-0224-05-TNC-02
-06	M3933/17-06N	1.57 (39.9)	6.0	DC - 4.5	ATT-0224-06-TNC-02
-07	M3933/17-07N	1.57 (39.9)	20.0	DC - 18.0	ATT-0225-20-TNC-02
-08	M3933/17-08N	1.84 (46.7)	30.0	DC - 18.0	ATT-0225-30-TNC-02
-09	M3933/17-09N	1.57 (39.9)	1.0	DC - 18.0	ATT-0225-01-TNC-02
-10	M3933/17-10N	1.57 (39.9)	2.0	DC - 18.0	ATT-0225-02-TNC-02
-11	M3933/17-11N	1.57 (39.9)	3.0	DC - 18.0	ATT-0225-03-TNC-02
-12	M3933/17-12N	1.57 (39.9)	4.0	DC - 18.0	ATT-0225-04-TNC-02
-13	M3933/17-13N	1.57 (39.9)	5.0	DC - 18.0	ATT-0225-05-TNC-02
-14	M3933/17-14N	1.57 (39.9)	6.0	DC - 18.0	ATT-0225-06-TNC-02
-15	M3933/17-15N	1.57 (39.9)	7.0	DC - 18.0	ATT-0225-07-TNC-02
-16	M3933/17-16N	1.57 (39.9)	8.0	DC - 18.0	ATT-0225-08-TNC-02
-17	M3933/17-17N	1.57 (39.9)	10.0	DC - 18.0	ATT-0225-10-TNC-02
-18	M3933/17-18N	1.57 (39.9)	12.0	DC - 18.0	ATT-0225-12-TNC-02
-19	M3933/17-19N	1.57 (39.9)	15.0	DC - 18.0	ATT-0225-15-TNC-02
-20	M3933/17-20N	1.84 (46.7)	25.0	DC - 18.0	ATT-0225-25-TNC-02
-21	M3933/17-21N	1.84 (46.7)	35.0	DC - 18.0	ATT-0225-35-TNC-02
-22	M3933/17-22N	1.84 (46.7)	40.0	DC - 18.0	ATT-0225-40-TNC-02

Notes:

1. Midwest Microwave part number reflects a non-screened part. For a screened part, change suffix "N" to "S".
2. See Appendix for description of connector interface.

SMA Connectors for Flexible Cable

MIL-PRF-39012/55

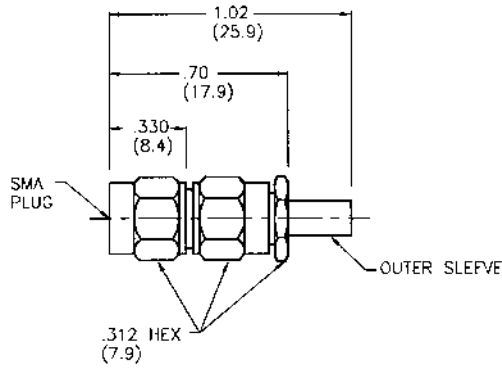

Figure 1

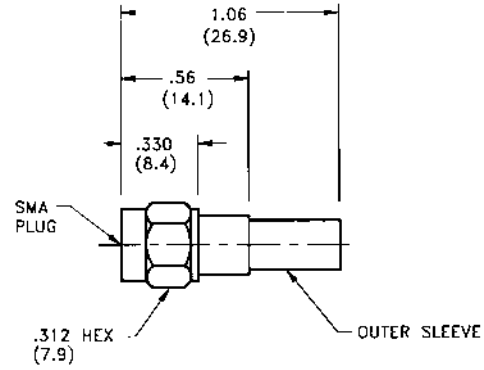

Figure 2

Military Part No.	Midwest Part No.	Figure	Assembly Procedure	Category	Cable Type	Commercial Alternate
-3006	M39012/55-3006	1	SMA -051	A	I	SMA-0196-55-000-02
-3007	M39012/55-3007	1	SMA -051	A	II	SMA-0188-55-000-02
-3008	M39012/55-3008	2	SMA -027	A	III	SMA-0122-55-000-02
-3009	M39012/55-3009	2	SMA -027	A	IV	SMA-0142-55-000-02
-3010	M39012/55-3010	2	SMA -027	A	V	SMA-0142-55-000-02
-3025	M39012/55-3025	1	SMA -051	C	I	SMA-1196-55-000-02
-3026	M39012/55-3026	1	SMA -051	C	II	SMA-1188-55-000-02
-3028	M39012/55-3028	2	SMA -027	C	IX	SMA-1055-55-000-02
-3029	M39012/55-3029	2	SMA -027	C	X	SMA-1058-55-000-02
-3030	M39012/55-3030	1	SMA -051	A	XV	SMA-0316-55-000-02
-3106	M39012/55-3106	1	SMA -051	A	I	SMA-0196-55-000-02
-3107	M39012/55-3107	1	SMA -051	A	II	SMA-0188-55-000-02
-3109	M39012/55-3109	2	SMA -027	A	IV	SMA-0142-55-000-02
-3110	M39012/55-3110	2	SMA -027	A	V	SMA-0142-55-000-02
-3125	M39012/55-3125	1	SMA -051	C	I	SMA-1196-55-000-02
-3126	M39012/55-3126	1	SMA -051	C	II	SMA-1188-55-000-02
-3128	M39012/55-3128	2	SMA -027	C	IX	SMA-1055-55-000-02
-3129	M39012/55-3129	2	SMA -027	C	X	SMA-1058-55-000-02
-3130	M39012/55-3130	1	SMA -051	A	XV	SMA-0316-55-000-02
-3502	M39012/55-3502	2	SMA -027	D	I	SMA-1055-55-000-02
-3602	M39012/55-3602	2	SMA -027	D	XI	SMA-1055-55-000-02

Notes:

1. Coupling nut is passivated and lockwire safety holes are not used on -3100 and -3600 series part numbers.
2. Connector housings are gold plated for soldering of cable outer conductor.
3. Category A: solder sleeve; Categories B, C, and D: crimp sleeve.

MIL-PRF-39012/57

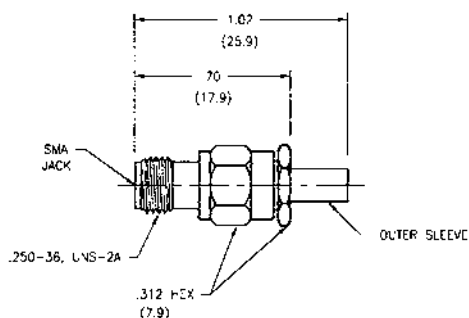

Figure 1

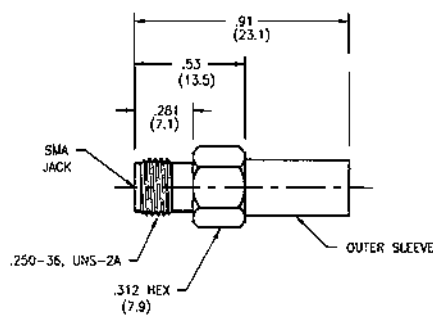

Figure 2

Military Part No.	Midwest Part No.	Figure	Assembly Procedure	Category	Cable Type	Commercial Alternate
- 3006	M39012/57-3006	1	SMA -052	A	I	SMA-0196-57-000-02
- 3007	M39012/57-3007	1	SMA -052	A	II	SMA-0188-57-000-02
- 3009	M39012/57-3009	2	SMA -026	A	IV	SMA-0142-57-000-02
- 3010	M39012/57-3010	2	SMA -026	A	V	SMA-0142-57-000-02
- 3025	M39012/57-3025	1	SMA -052	C	I	SMA-1196-57-000-02
- 3026	M39012/57-3026	1	SMA -052	C	II	SMA-1188-57-000-02
- 3028	M39012/57-3028	2	SMA -026	C	IX	SMA-1055-57-000-02
- 3029	M39012/57-3029	2	SMA -026	C	X	SMA-1058-57-000-02
- 3030	M39012/57-3030	1	SMA -052	A	XV	SMA-0316-57-000-02
- 3502	M39012/57-3502	2	SMA -026	D	XI	SMA-1055-57-000-02

SMA Connectors Panel Mount Type

MIL-PRF-39012/58

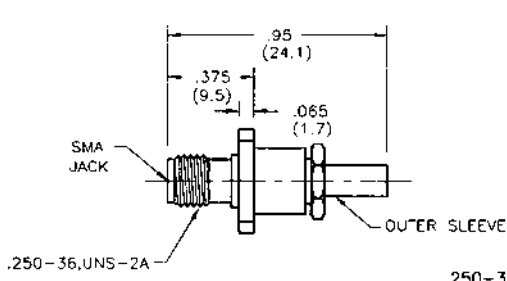
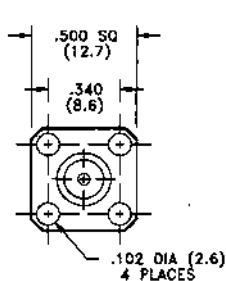

Figure 3

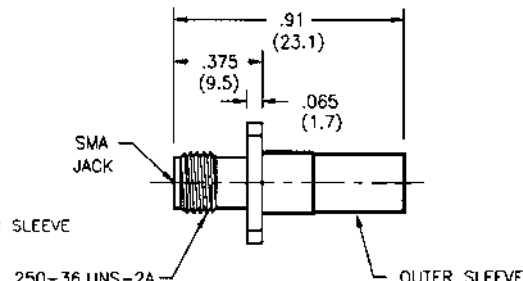

Figure 4

Military Part No.	Midwest Part No.	Figure	Assembly Procedure	Category	Cable Type	Commercial Alternate
- 3006	M39012/58-3006	3	SMA -053	A	I	SMA-0196-58-000-02
- 3007	M39012/58-3007	3	SMA -053	A	II	SMA-0188-58-000-02
- 3009	M39012/58-3009	4	SMA -054	A	IV	SMA-0142-58-000-02
- 3010	M39012/58-3010	4	SMA -054	A	V	SMA-0142-58-000-02
- 3025	M39012/58-3025	3	SMA -053	C	I	SMA-1196-58-000-02
- 3026	M39012/58-3026	3	SMA -053	C	II	SMA-1188-58-000-02
- 3028	M39012/58-3028	4	SMA -054	C	IX	SMA-1055-58-000-02
- 3029	M39012/58-3029	4	SMA -054	C	X	SMA-1058-58-000-02
- 3030	M39012/58-3030	3	SMA -053	A	XV	SMA-0316-58-000-02
- 3502	M39012/58-3502	4	SMA -054	D	XI	SMA-1055-58-000-02

SMA Connectors Panel Mount Type

MIL-PRF-39012/60

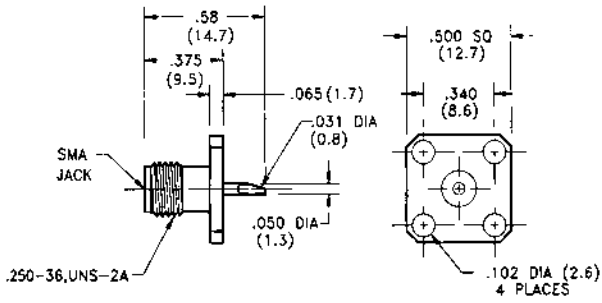

Figure 1

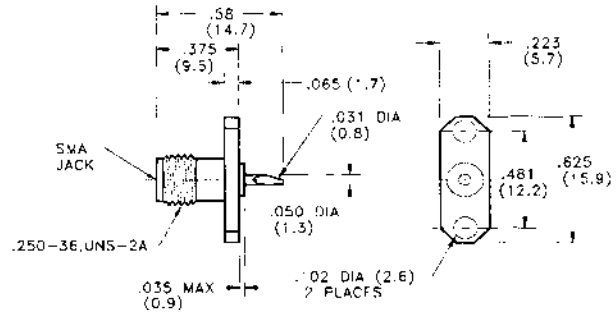

Figure 2

Military Part No.	Midwest Part No.	Figure	Commercial Alternate
- 3001	M39012/60-3001	1	SMA-5540-15-000-02
- 3002	M39012/60-3002	2	SMA-5240-15-000-02

SMA Connectors for Semi-Rigid Cable

MIL-PRF-39012/79

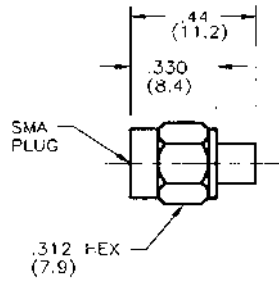

Figure 1

Military Part No.	Midwest Part No.	Figure	Assembly Procedure	Category	Cable Type	Commercial Alternate
- B3001	M39012/79B3001	1	SMA-057	B	XII	SMA-0085-79-000-02
- B3002	M39012/79B3002	1	SMA-058	B	XIII	SMA-0141-79-000-02
- 3007	M39012/79-3007	1	SMA-059	E	XII	SMA-4085-79-000-02
- 3008	M39012/79-3008	1	SMA-024	E	XIII	SMA-4141-79-000-02
- B3101	M39012/79-3101	1	SMA-057	B	XII	SMA-0085-79-000-02
- B3102	M39012/79-3102	1	SMA-058	B	XIII	SMA-0141-79-000-02
- 3107	M39012/79-3107	1	SMA-059	E	XII	SMA-4085-79-000-02
- 3108	M39012/55-3029	1	SMA-024	E	XIII	SMA-4141-79-000-02

MIL-PRF-39012/81

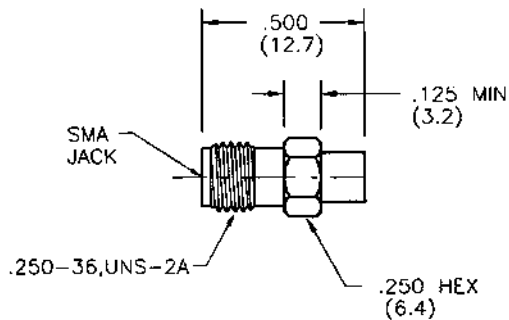

Figure 1

Military Part No.	Midwest Part No.	Figure	Assembly Procedure	Category	Cable Type	Commercial Alternate
- 3005	M39012/81-3005	1	SMA-060	B	XII	SMA-0085-81-000-00
- 3006	M39012/81-3006	1	SMA-023	B	XIII	SMA-0141-81-000-00
- 3007	M39012/81-3007	1	SMA-061	E	XII	SMA-4085-81-000-00
- 3008	M39012/81-3008	1	SMA-062	E	XIII	SMA-4141-81-000-00

MIL-PRF-39012/82

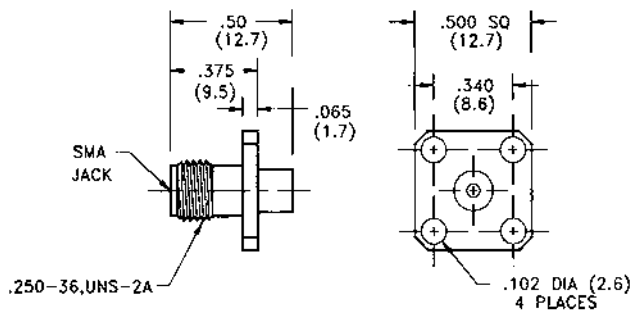

Figure 1

Military Part No.	Midwest Part No.	Figure	Assembly Procedure	Category	Cable Type	Commercial Alternate
- 3005	M39012/82-3005	2	SMA-063	E	XII	SMA-0085-82-000-00
- 3006	M39012/82-3006	2	SMA-064	E	XIII	SMA-0141-82-000-00
- 3007	M39012/82-3007	2	SMA-065	E	XII	SMA-4085-82-000-00
- 3008	M39012/82-3008	2	SMA-066	E	XIII	SMA-4141-82-000-00

Notes:

1. Housing to be gold plated.
2. Category A: solder sleeve; Categories B, C and D: crimp sleeve.
3. See Appendix for description of connector interfaces, categories and cable types.

SMA Connectors for Semi-Rigid Cable

MIL-C-39012/92

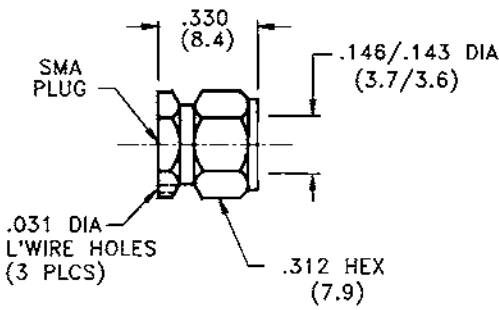

Figure 1

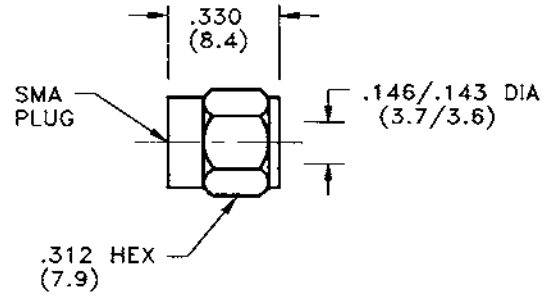

Figure 2

Military Part No.	Midwest Part No.	Figure	Assembly Procedure	Category	Cable Type	Commercial Alternate
- B3001	M39012/92B3001	1	SMA-022	E	XIII	SMA-0141-92-000-02
- B3003	M39012/92-3003	1	SMA-022	E	XIII	SMA-0141-92-000-02
- B3101	M39012/92B3101	2	SMA-022	E	XIII	SMA-0141-92-000-02
- B3103	M39012/92-3103	2	SMA-022	E	XIII	SMA-0141-92-000-02

- Notes:
1. Coupling nut is passivated and lockwire safety holes are not used on - 3100 series part numbers.
 2. Connector housings are gold plated for soldering of cable outer conductor.
 3. See Appendix for description of connector interfaces, categories and cable types.

SMA Printed Circuit Mount Connectors

MIL-PRF-39012/93

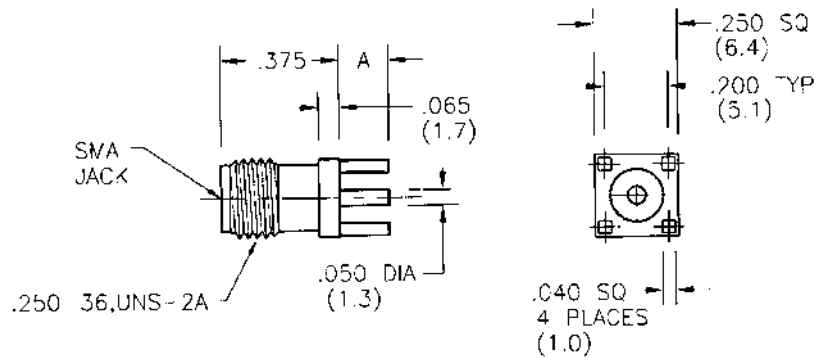

Military Part No.	Midwest Part No.	Dimension A (max.)	Commercial Alternate
- 3001	M39012/93-3001	.155 (3.9)	SMA-5010-93-PCB-00
- 3002	M39012/93-3002	.125 (3.2)	N/A
- 3003	M39012/93-3003	.093 (2.4)	NA

MIL-PRF-39012/94

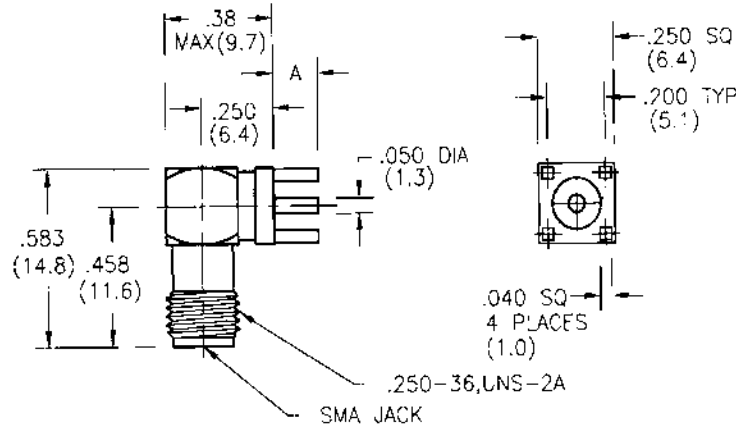

Military Part No.	Midwest Part No.	Dimension A (max.)	Commercial Alternate
- 3001	M39012/94-3001	.155 (3.9)	SMA-5010-93-PCB-00
- 3002	M39012/94-3002	.125 (3.2)	N/A
- 3003	M39012/94-3003	.093 (2.4)	N/A

Notes:
1. See Appendix for description of connector interface.

Terminations (Dummy Loads)

N Type Terminations MIL-DTL-39030/6

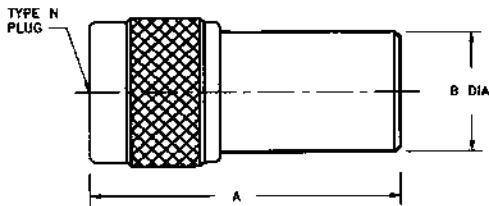

Figure 1

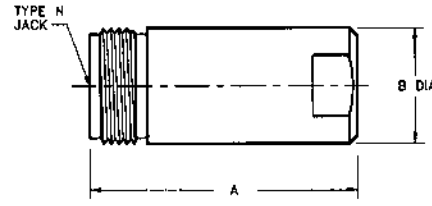
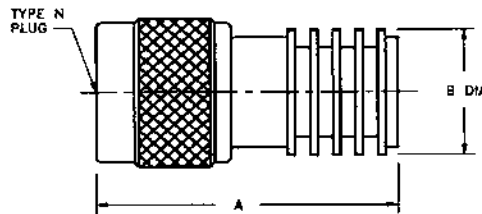

Figure 2



10 WATT
Figure 3

Military Part No.	Midwest Part No.	Figure	Dimension A inches (mm)	Dimension B inches (mm)	Commercial Alternate
- 01	M39030/6-01N	1	1.60 (40.6)	.625 (15.9)	TRM-2053-MO-NNN-02
- 02	M39030/6-02N	1	1.60 (40.6)	.625 (15.9)	TRM-2053-MO-NNN-02
- 03	M39030/6-03N	1	1.51 (38.4)	.380 (9.70)	TRM-2053-MO-NNN-02
- 04	M39030/6-04N	2	1.48 (37.6)	.380 (9.70)	TRM-2053-FO-NNN-02
- 05	M39030/6-05N	3	1.60 (40.6)	.700 (17.8)	TRM-2080-MO-NNN-07
- 06	M39030/6-06N	1	1.60 (40.6)	.625 (15.9)	TRM-2169-MO-NNN-02
- 07	M39030/6-07N	2	1.60 (40.6)	.625 (15.9)	TRM-2169-FO-NNN-02

Notes:
1. Midwest Microwave part number reflects a non-screened part. For a screened part, change suffix "N" to "S".

Terminations (Dummy Loads)

SMA Type Terminations MIL-DTL-39030/3

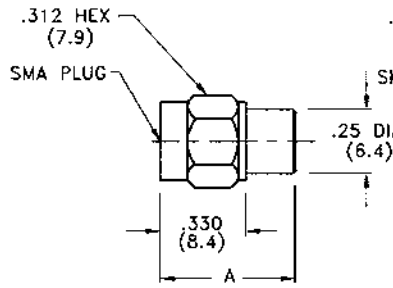

Figure 1

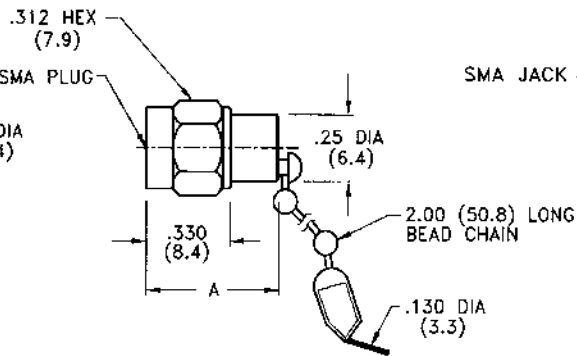

Figure 2

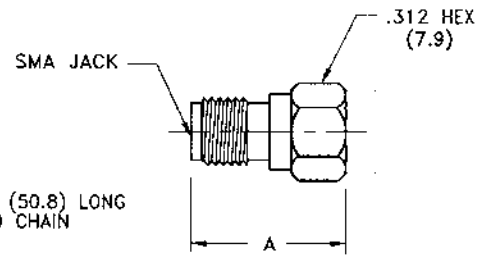

Figure 3

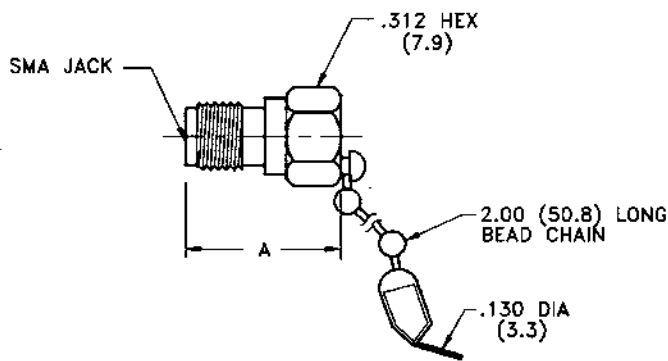

Figure 4

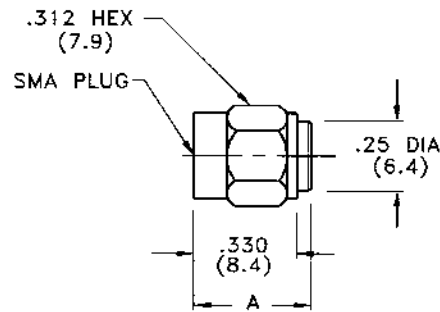

Figure 5

Military Part No.	Midwest Part No.	Figure	Dimension A inches (mm)	Commercial Alternate
-01	M39030/3-01N	1	.52 (13.2)	TRM-2090-MO-SMA-00
-02	M39030/3-02N	1	.52 (13.2)	TRM-2090-MO-SMA-02
-03	M39030/3-03N	2	.52 (13.2)	TRM-2090-MC-SMA-00
-04	M39030/3-04N	2	.52 (13.2)	TRM-2090-MC-SMA-02
-05	M39030/3-05N	3	.53 (13.5)	TRM-2090-FO-SMA-00
-06	M39030/3-06N	3	.53 (13.5)	TRM-2090-FO-SMA-02
-07	M39030/3-07N	4	.53 (13.5)	TRM-2090-FC-SMA-00
-08	M39030/3-08N	4	.53 (13.5)	TRM-2090-FC-SMA-02
-09	M39030/3-09N	1	.52 (13.2)	TRM-2090-MO-SMA-00
-11	M39030/3-11N	5	.39 (9.90)	TRM-2444-MO-SMA-00
-12	M39030/3-12N	1	.52 (13.2)	TRM-2090-MO-SMA-00
-13	M39030/3-13N	2	.52 (13.2)	TRM-2090-MC-SMA-00
-14	M39030/3-14N**	1	.52 (13.2)	TRM-2090-MO-750-00
-15	M39030/3-15N	1	.52 (13.2)	TRM-2090-MO-SMA-00

Notes:

1. Midwest Microwave part number reflects a non-screened part. For a screened part, change suffix "N" to "S".
2. ** CAUTION - M39030/3-14N is a 75 Ohm Termination.

Definition of Categories	Category A	Flexible Cable Field serviceable, no special tools required to assemble. Standard wrenches, soldering equipment, pliers, etc. are not defined as special tools. Captured center contacts.
	Category B	Flexible and Semi-Rigid Cable Non-field replaceable, special tools may be used for original installations. Field replacement is intended to be made by category A or C connectors. They will not be inventoried or procured by the U.S. Government. Captured and non-captured center contacts.
	Category C	Flexible Cable Field replaceable. Requires crimp tool and specified cable stripping dimensions. Captured center contacts.
	Category D	Flexible Cable Field replaceable. Requires crimp tool for center contact and outer fer rule; specified cable stripping dimensions, (same as category C), and defined piece parts. Captured center contact.
	Category E	Semi-Rigid Cable Field replaceable. Requires specified cable stripping dimensions. Captured and non-captured center contacts. Uses standard assembly tool kit: Midwest Microwave Part No. TLS-0001-98-000-54.
	Category F	Semi-Rigid Cable Field replaceable. Requires crimp tool and specified cable stripping dimensions. Captured center contact.

Definition of Categories	I.	RG 178/U	X.	RG 58/U, 303
	II.	RG 174/U, 316	XI.	RG 142/U, 400
	III.	RG 122/U	XII.	RG 405/U (.085 semi-rigid)
	IV.	RG 58/U, 142, 223	XIII.	RG 402/U (.141 semi-rigid)
	V.	RG 303/U	XIV.	RG 179/U
	VI.	RG 58/U	XV.	RG 174/U, 187, 188, 316
	VII.	RG 142/U	XVI.	RG 55/U, 187, 188, 316
	VIII.	RG 223/U	XVII.	RG 55/U, 142, 223, 400
	IX.	RG 142/U, 223		

SMA Connectors – Semi-Rigid Cable

Captured Center Contact

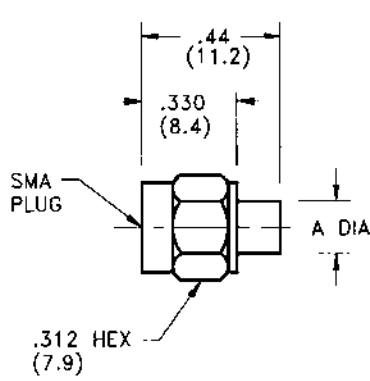

Figure 1

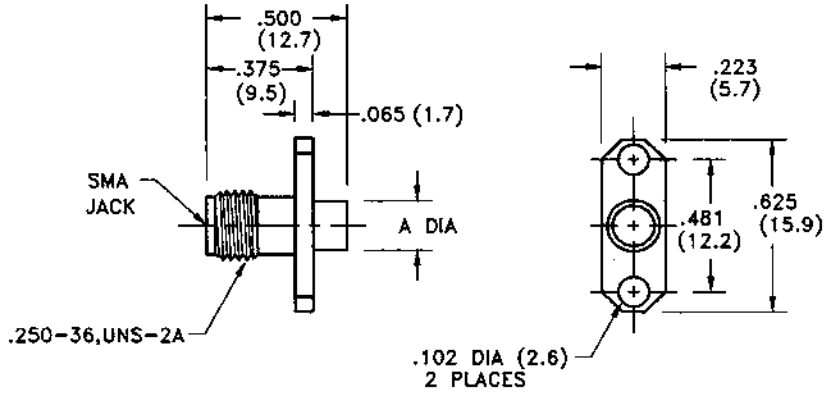

Figure 2

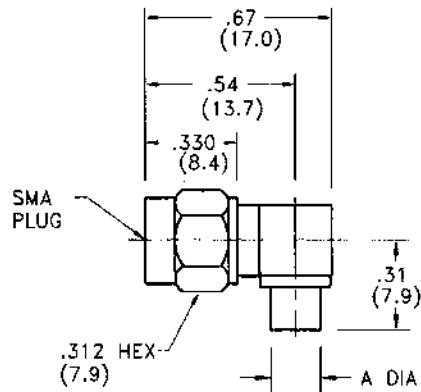

Figure 3

Military Part No.	Midwest Part No.	Figure	Dimension A inches (mm)	Dimension B inches (mm)	Cable Type	Commercial Alternate
84149SSG	SMA-4141-79-002-02	1	.180 (4.6)	SMA-071	XIII	SMA-4141-89-000-02
84149SSG-1	SMA-0141-79-010-02	1	.180 (4.6)	SMA-071	XIII	SMA-4141-89-000-02
84149SSGA	SMA-4085-79-005-02	1	.120 (3.0)	SMA-071	XII	SMA-4085-89-000-02
84149SSGA-1	SMA-4085-79-002-02	1	.120 (3.0)	SMA-071	XII	SMA-4085-89-000-02
85022SSG	SMA-4141-82-003-00	2	.180 (4.6)	SMA-076	XIII	SMA-4141-82-000-00
85022SSGA	SMA-4085-82-004-00	2	.120 (3.0)	SMA-076	XII	SMA-4085-82-000-00
85037SSG	SMA-0141-80-005-02	3	.180 (4.6)	SMA-075	XIII	SMA-0141-80-000-02
85037SSGA	SMA-0085-80-004-02	3	.120 (3.0)	SMA-075	XII	SMA-0085-80-000-02

Notes:

- * Defense Electronic Supply Center, Dayton, OH. The name was changed to Defense Logistics Agency (DLA), however existing DESC drawings and specifications did not change.
- See Appendix for description of connector interfaces.

Non-Captured Center Contact

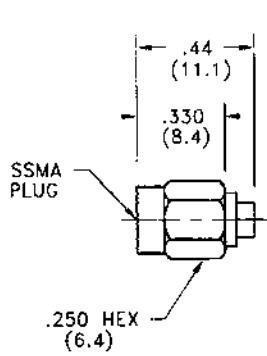

Figure 1

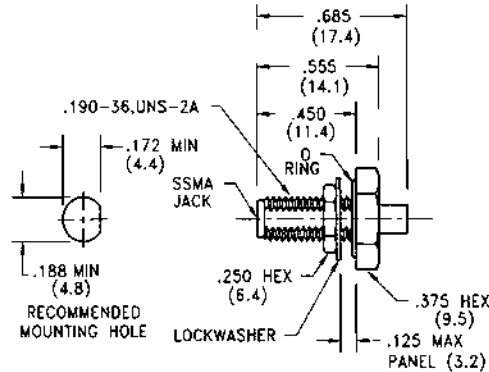

Figure 2

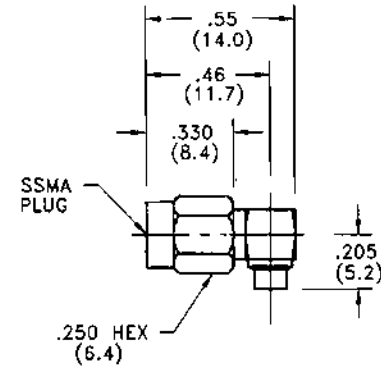

Figure 3

DESC Part No.	Midwest Part No.	Figure	Assembly Procedure	Cable Type	Commercial Alternate
86116ZSG	SSM-0085-79-001-02	1	SSM-003	XII	SSM-0085-79-000-02
86117ZSG	SSM-0085-83-001-00	2	SSM-005	XII	SSM-0085-83-000-00
86118ZSG	SSM-0085-80-001-02	3	SSM-004	XII	SSM-0085-80-000-02

Captured Center Contact

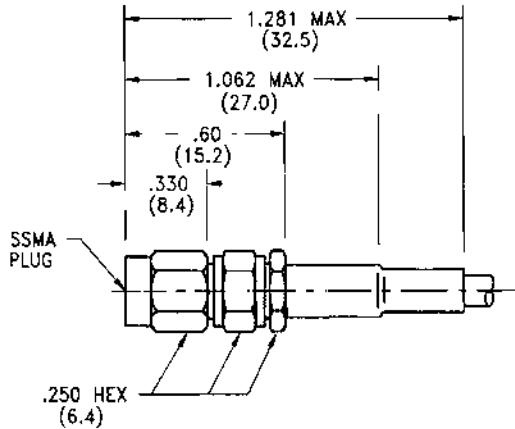

Figure 4

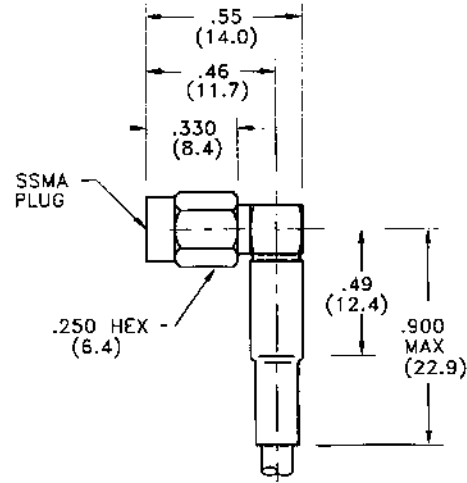

Figure 5

DESC Part No.	Midwest Part No.	Figure	Assembly Procedure	Cable Type	Commercial Alternate
86119ZSG	SSM-3188-55-001-02	4	SSM-006	II, XIV	SSM-3188-56-001-02
86120ZSG	SSM-3188-56-001-02	5	SSM-007	II, XIV	SSM-3188-56-000-02

Notes:

- * Defense Electronic Supply Center, Dayton, OH. The name was changed to Defense Logistics Agency (DLA), however existing DESC drawings and specifications did not change.
- See Appendix for description of connector interfaces.

BMA – Blind Mate Connectors

Semi-Rigid Cable Types

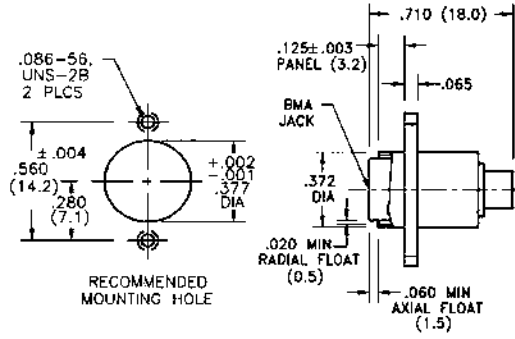

Figure 1

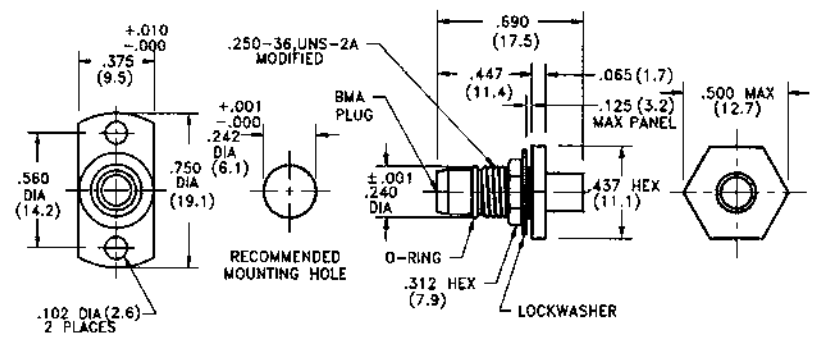

Figure 2

Flexible Cable Types

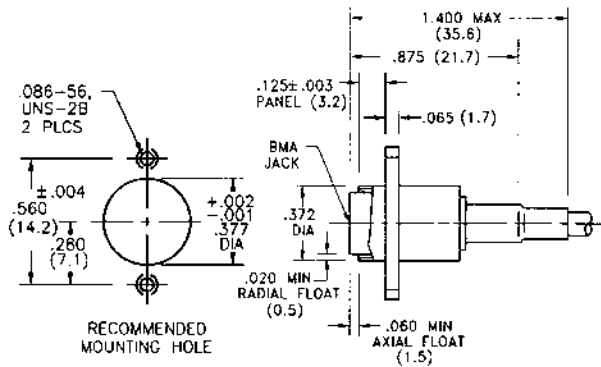

Figure 3

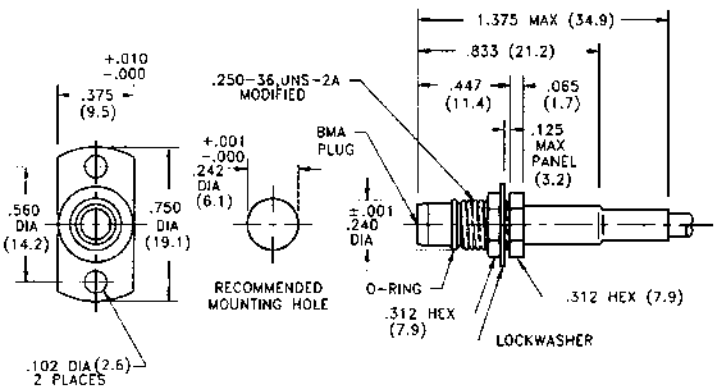

Figure 4

DESC Part No.	Midwest Part No.	Figure	Assembly Procedure	Cable Type	Commercial Alternate
85071ZSGA	BMA-4141-82-001-00	1	BMA-003	XIII	
85071ZSGA-1	BMA-4141-82-002-00	1	BMA-003	XIII	BMA-4141-82-002-02
85071ZSGB	BMA-4085-82-001-00	1	BMA-003	XII	
85071ZSGB-1	BMA-4085-82-002-00	1	BMA-003	XII	BMA-4085-82-002-02
85072ZSGA	BMA-4141-86-001-02	2	BMA-004	XIII	BMA-4141-86-000-02
85072ZSGB	BMA-4085-86-001-00	2	BMA-004	XII	BMA-4085-86-000-02
85073ZSGA	BMA-3188-58-001-02	3	BMA-005	XIV, XVI	BMA-3188-58-000-02
85073ZSGA-1	BMA-3188-58-002-02	3	BMA-00	XIV, XVI	BMA-3188-58-000-02
85073ZSGB	BMA-3055-58-001-02	3	BMA-005	XVII	BMA-3055-58-000-02
85073ZSGB-1	BMA-3055-58-002-02	3	BMA-005	XVII	BMA-3055-58-000-02
85074ZSGA	BMA-3188-51-002-02	4	BMA-002	XIV, XV	BMA-3188-51-000-02
85074ZSGB	BMA-3055-51-001-02	4	BMA-002	XVII	BMA-3055-51-000-02

Notes:

1. Finish: Housing that is to be soldered to cable outer conductor is gold plated. Outer housing is passivated stainless steel. If gold plating is desired on entire connector, change part number suffix from -02 to -00. Center conductors are gold plated.
2. * Defense Electronic Supply Center, Dayton, OH. The name was changed to Defense Logistics Agency (DLA), however existing DESC drawings and specifications did not change.
3. See Appendix for description of connector interfaces.

TNC to SMA Adapters

TNC to SMA Adapters

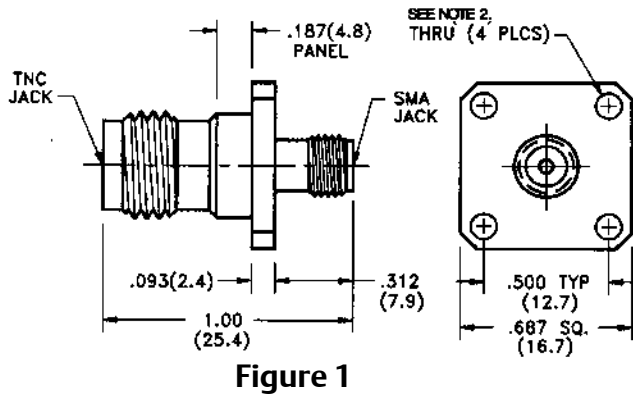

Figure 1

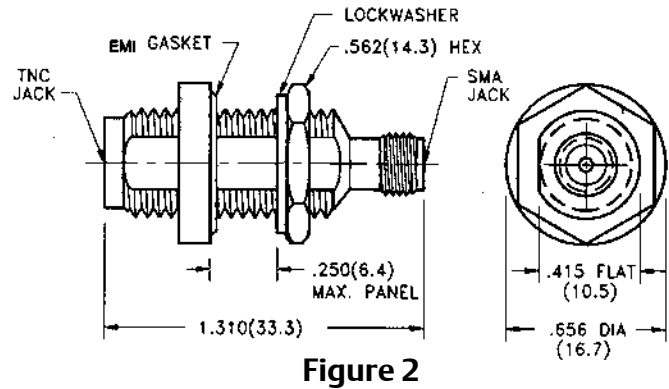

Figure 2

Type N to SMA Adapters

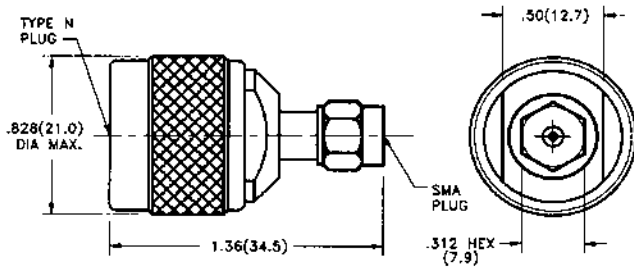

Figure 3

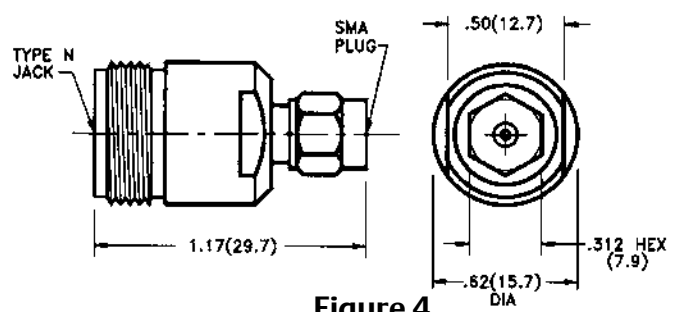

Figure 4

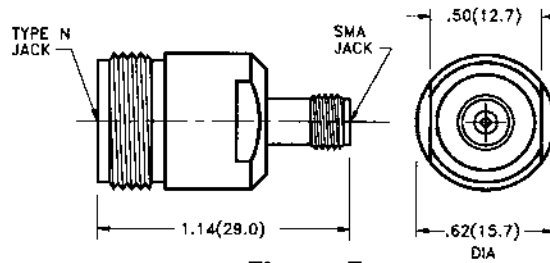

Figure 5

DESC Part No.	Midwest Part No.	Figure	Description	Commercial Alternate
01814FP-1**	ADT-2699-FF-012-02	1	TNC Panel Female to SMA Female	ADT-2699-TF-SMF-02
8501814FP-2***	ADT-2699-FF-022-02	1	TNC Panel Female to SMA Female	ADT-2699-FF-013-02
8501814BP-3	ADT-2779-FF-004-02	2	TNC Blkhd Female to SMA Female	ADT-2779-TF-SMF-02
8604412SP-1	ADT-2580-MM-002-02	3	N Male to SMA Male	ADT-2580-NM-SMM-02
8604412SP-2	ADT-2676-MF-001-02	4	N Female to SMA Male	ADT-2682-NF-SMM-02
8604412SP-3	ADT-2683-FF-002-02	5	N Female to SMA Female	ADT-2683-NF-SMF-02

Notes:

1. Finish: Housing outer conductor is passivated stainless steel and center conductors are gold plated. If gold plating is desired on entire adapter, change part number suffix from -02 to -00.
2. ** .125 (3.2) Dia Thru Holes (4 Places) - *** #3-56 UNF Tapped Holes.
3. * Defense Electronic Supply Center, Dayton, OH. The name was changed to Defense Logistics Agency (DLA), however existing DESC drawings and specifications did not change.
4. See Appendix for description of connector interfaces.

Type N to SMA Adapters

Type N to SMA Adapters

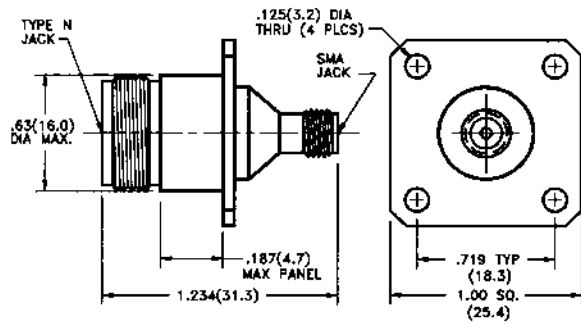

Figure 1

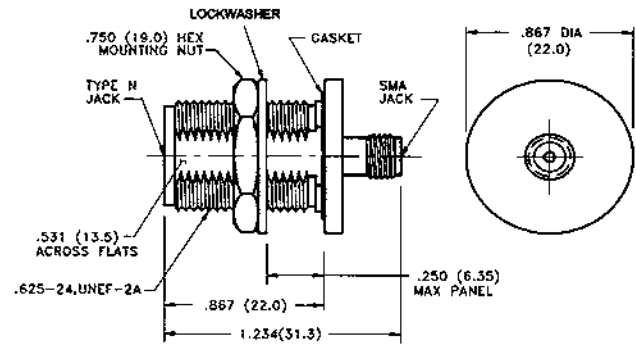

Figure 2

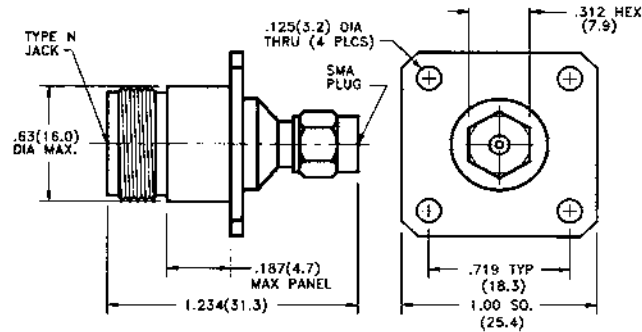

Figure 3

DESC Part No.	Midwest Part No.	Figure	Commercial Alternate	Alternate
8503812FP-3	ADT-2599-FF-005-02	2	N Blkhf Female to SMA Female	ADT-2840-NF-SMF-02
8503812FP-4**	ADT-2578-MF-010-02	3	N Panel Female to SMA Male	ADT-2578-NF-SMM-02
8503812FP-5***	ADT-2578-MF-008-02	3	N Panel Female to SMA Male	ADT-2578-MF-009-02
8503812FP-6**	ADT-2579-FF-016-02	1	N Panel Female to SMA Female	ADT-2579-NF-SMF-02
8503812FP-7***	ADT-2579-FF-017-02	1	N Panel Female to SMA Female	ADT-2682-NF-SMM-02

Notes:

1. Finish: Housing outer conductor is passivated stainless steel and center conductors are gold plated.
If gold plating is desired on entire adapter, change part number suffix from -02 to -00.
2. ** .125 (3.2) Dia Thru Holes (4 Places) - *** #3-56 UNF Tapped Holes.
3. * Defense Electronic Supply Center, Dayton, OH. The name was changed to Defense Logistics Agency (DLA), however existing DESC drawings and specifications did not change.
4. See Appendix for description of connector interfaces.

Category E Assembly Kit for SMA Connectors

Kit Model No.: TLS-0001-98-000-54

NSN 5180-00-460-5262

The Assembly Tool Kit provides all of the necessary tools to install SMA Connectors on to .085 inch and .141 inch diameter semi-rigid cable.

Kit Contains:

- Assy Procedure Manual
- Center Contact Holder
- Dielectric Insert Tool
- Dielectric Recess Tool
- Fixture Sub-Assembly
- Inserts – .085 (2)
- Inserts – .141 (2)
- Locator Tool
- Retainer Ring Pliers
- Solder Gage – .010
- Solder Gage – .015
- Solder Gage – .018

Note:

1. Retainer Ring Pliers also sold separately as part # TLS-0014-98-000-54, NSN 5120-00-159-8850.
2. Remaining kit parts are not sold individually.

Torque Wrenches for Production use

- Interchangeable Wrench Heads
- Accurate Repeatability
- Pre-set Torque indicated by an audible “click”
- Dual Direction Wrench Movement
- Rugged Construction

Midwest Microwave’s Torque Wrenches are manufactured for production or laboratory use. They are extremely useful for accurate torque tightening of connector to connector interfaces on microwave components or for cable assembly installations in system integrations. The wrench heads are factory pre-set and are replaceable in all of the sizes offered.

Part No.	Hex Size inches (mm)	Used For Connector Type	Preset Torque
TLS-0049-98-NNN-54	13/16 (20.6)	SC/Type N (Hex Type)	14 in. lbs.
TLS-0027-98-7MM-54	3/4 (19.1)	7mm	14 in. lbs.
TLS-0029-98-TNC-54	5/8 (15.9)	TNC (Hex Type)	14 in. lbs.
TLS-0018-98-SMA-54	5/16 (7.90)	SMA	8 in. lbs.
TLS-0019-98-SSM-54	1/4 (6.40)	SSMA	8 in. lbs.

Table of Contents

Coaxial Interface Dimensions

This Appendix is meant to provide the user with some of the necessary supplementary information they may require to allow them to make reasonable and timely decisions on choices of types of components, connectors, coaxial cable and cable assemblies in order to complete an up to date microwave system or subsystem. Should the user be unable to locate the information they require, please contact the factory and further information will be provided.

Mechanical dimensional specifications are stated in inches with metric equivalents (to the nearest 0.01 mm) given for reference information only, and are based on 1" = 25.4 millimeters.

Coaxial Interface Dimensions.....	201
Flexible Coaxial Cable Information	205
VSWR vs Return Loss Table	206
Products Environmental Specifications.....	207
Space Qualified Parts.....	207
General Part Numbers Logic	208
Model Number - Page Number Index.....	209

3 Attenuators

31 Terminations

58 DC Blocks

61 Couplers

73 Power Dividers

81 Equalizers

85 Phase Shifters

87 Between Series Adapters

116 In-Series Adapters

127 Connectors

**177 QPL Approved Products &
Tools for Assembly**

200 Appendix

209 Index

SMA Interface Mating Dimensions

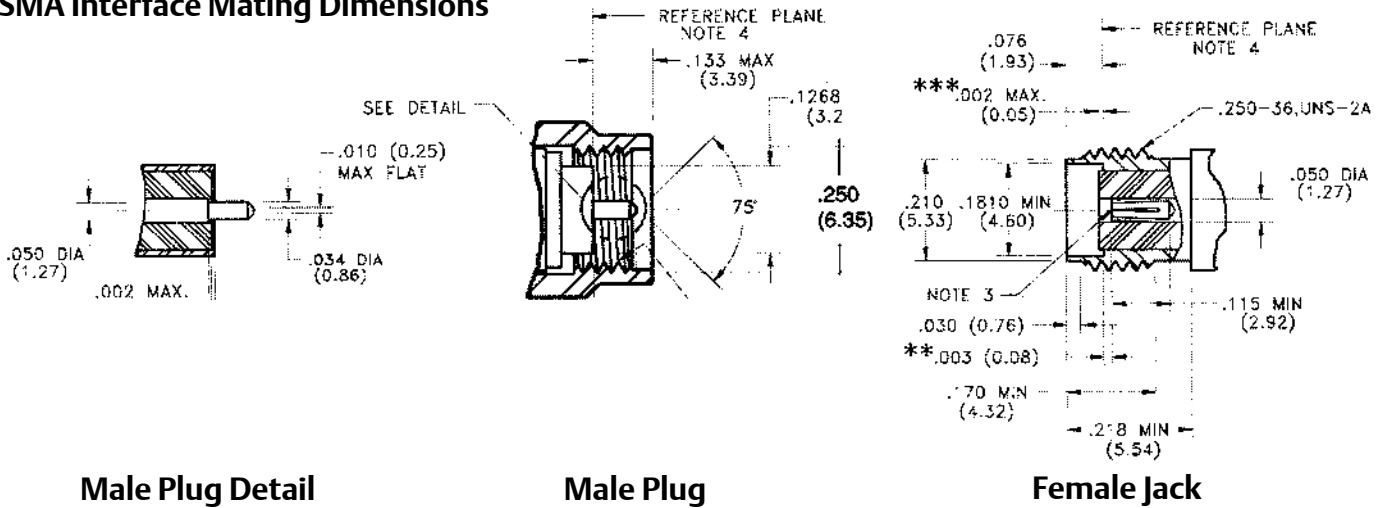

Male Plug Detail

Male Plug

Female Jack

SSMA Interface Mating Dimensions

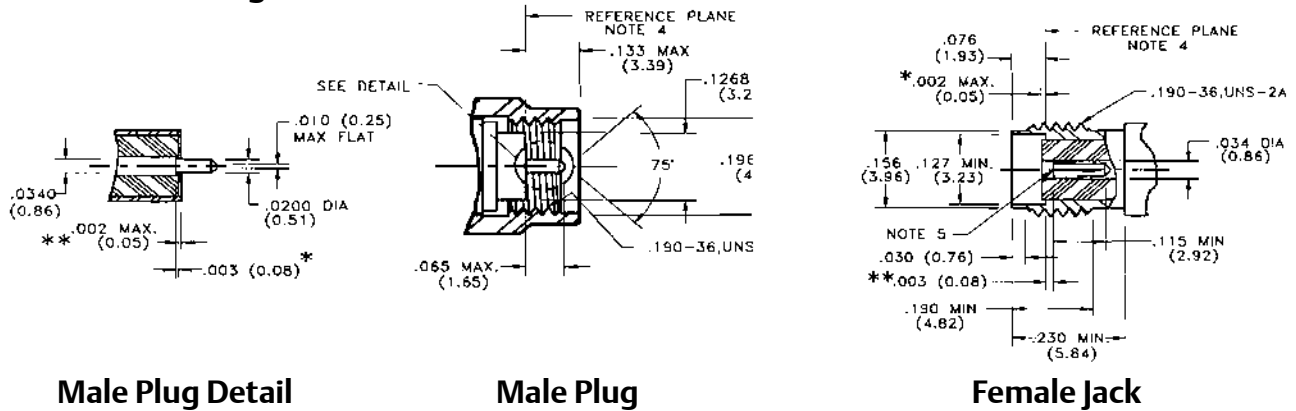

Male Plug Detail

Male Plug

Female Jack

BMA Interface Mating Dimensions

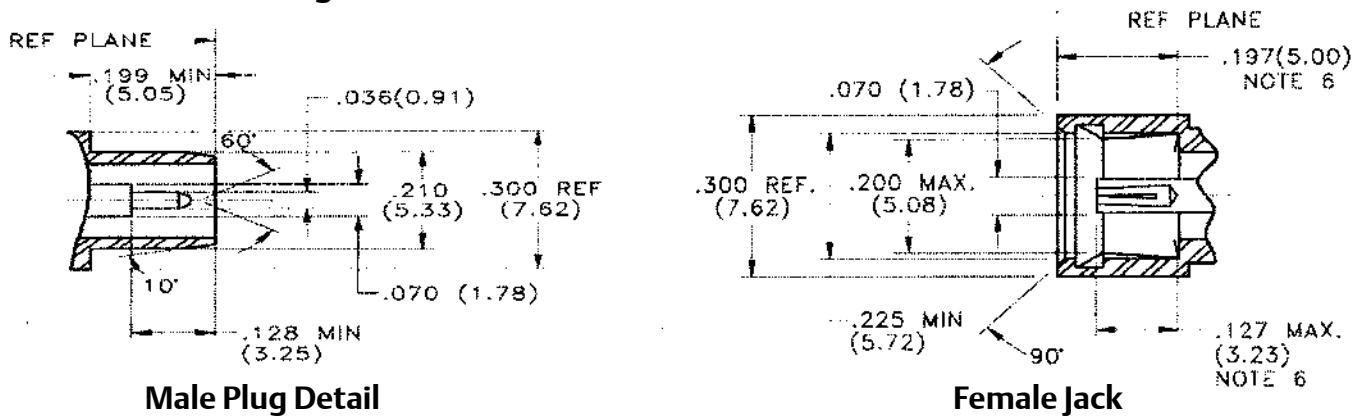

Male Plug Detail

Female Jack

* Dielectric Insulator Gap - measured from connector body reference plane .002 inches max. above to .010 inches max. below.
 ** Center Contact Gap - measured from connector body reference plane .000 inches min. (flush) to .010 max. below.
 *** Dielectric Insulator Gap - measured from connector body reference plane .002 inches max. above to .005 inches max. below.
 Notes:
 1. Except where specified, all dimensions shown are nominal.
 2. Metric equivalents (to the nearest 0.01 mm) are given for general information only and are based on 1 inch = 25.4 millimeters.
 3. ID to meet VSWR, and contact resistance when mated with .0360 +.0010/-.0005 (0.914 +.0254/-.0127 mm) diameter pin.
 4. When fully engaged, the two reference planes must coincide with metal to metal contact.
 5. ID to meet VSWR, and contact resistance when mated with .0200 +.0008/-.0005 (0.508 +.0203/-.0127 mm) diameter pin.
 6. Measured with outer contact spring bottomed as occurs in complete mating.

Coaxial Interface Dimensions

2.9 mm Precision Interface Mating Dimensions

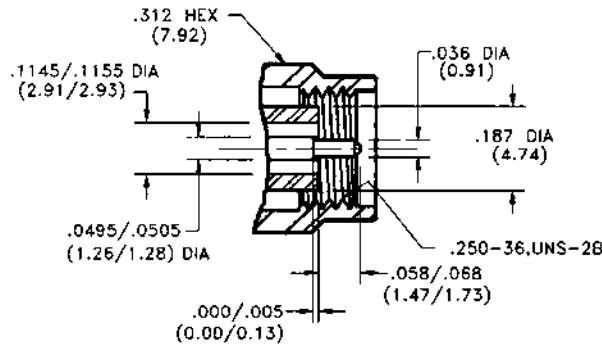

Male Plug

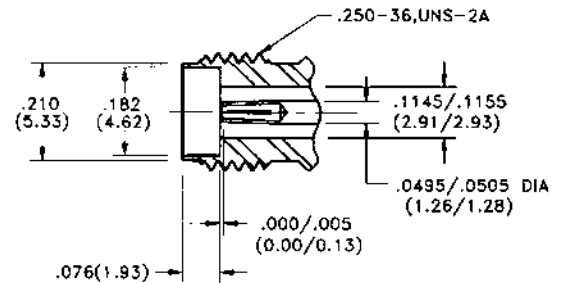

Female Jack

3.5 mm Precision Interface Mating Dimensions

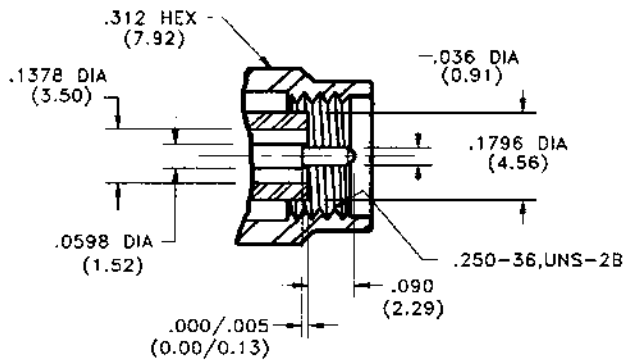

Male Plug

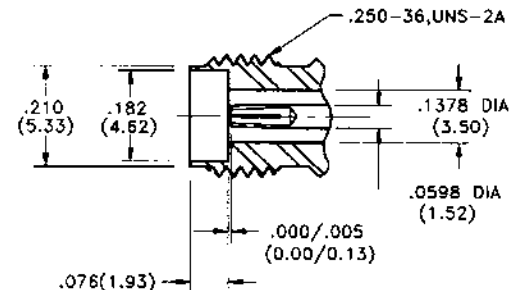

Female Jack

Type SMM Interface Mating Dimensions

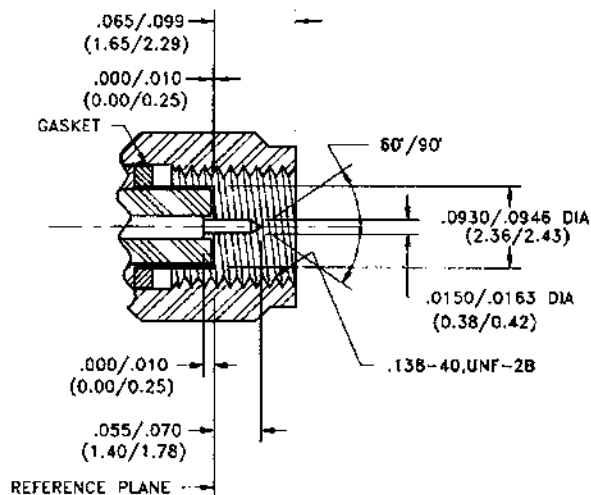

Male Plug

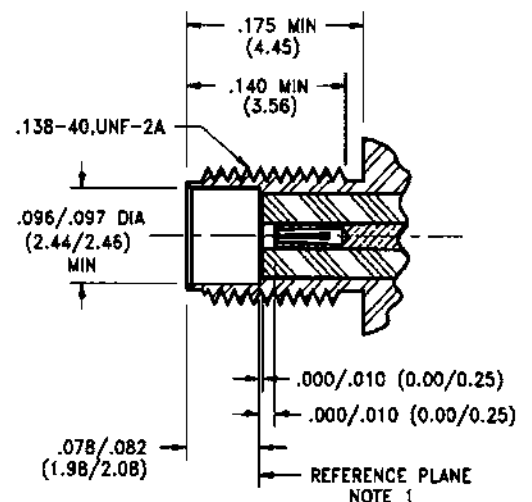

Female Jack

Type TNC Interface Mating Dimensions

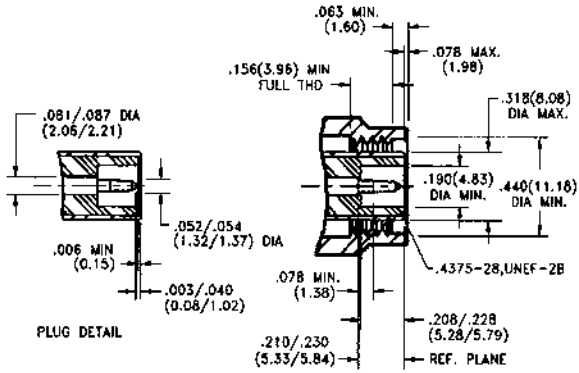

Male Plug

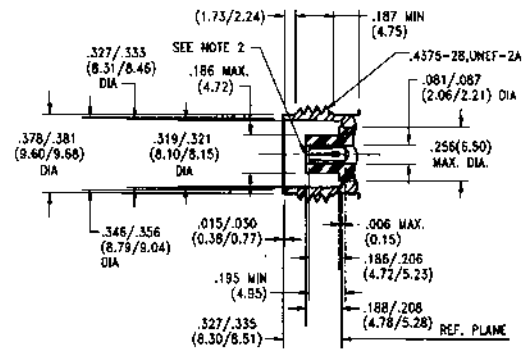

Female Jack

Type BNC Interface Mating Dimensions

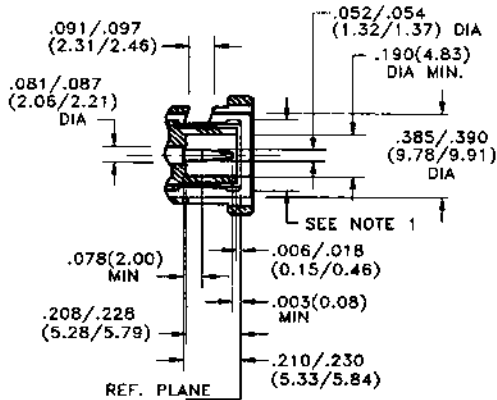

Male Plug

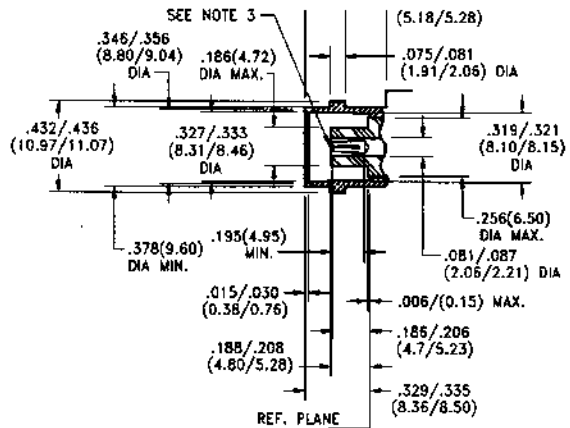

Female Jack

Type N Interface Mating Dimensions

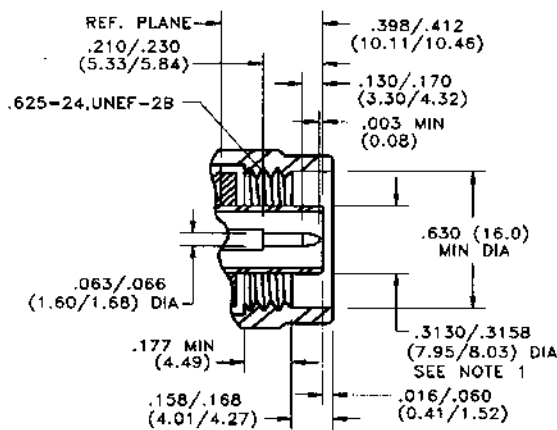

Male Plug

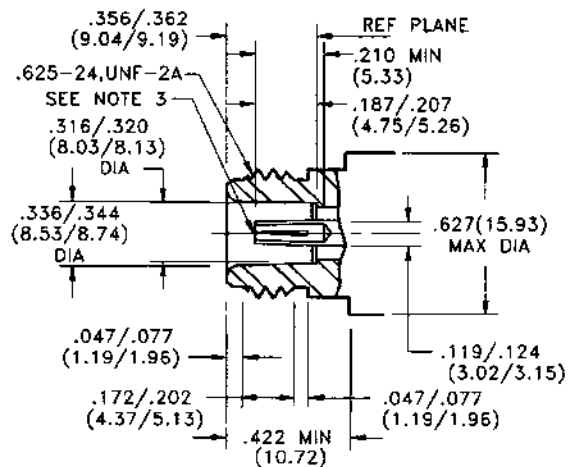

Female Jack

Notes:

1. I.D. to meet VSWR and contact resistance when mated with .052/.054 (1.32/1.37 mm) Diameter male pin.
2. I.D. to meet VSWR and contact resistance when mated with .063/.066 (1.60/1.68 mm) Diameter male pin.
3. Metric equivalents (to nearest 0.01 mm) are for general information only.

Coaxial Interface Dimensions

Type TNC-A Interface Mating Dimensions

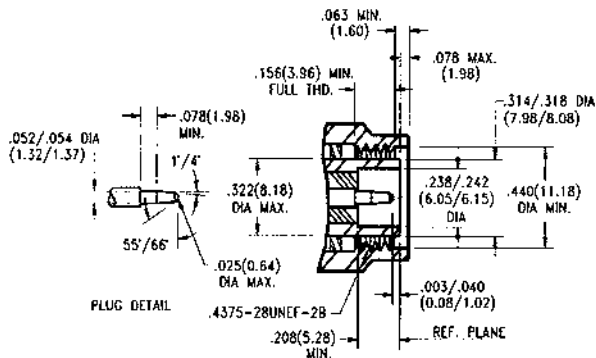

Male Plug

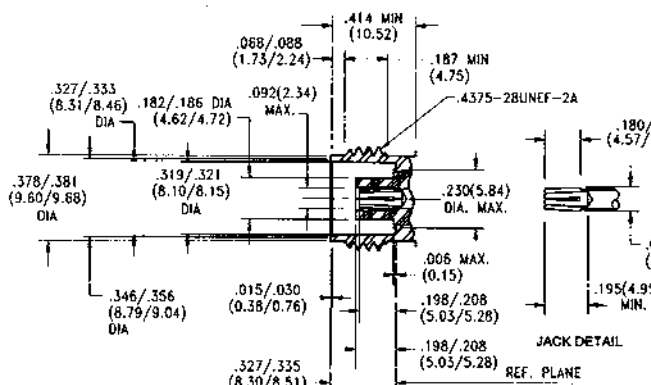

Female Jack

Type SC Interface Mating Dimensions

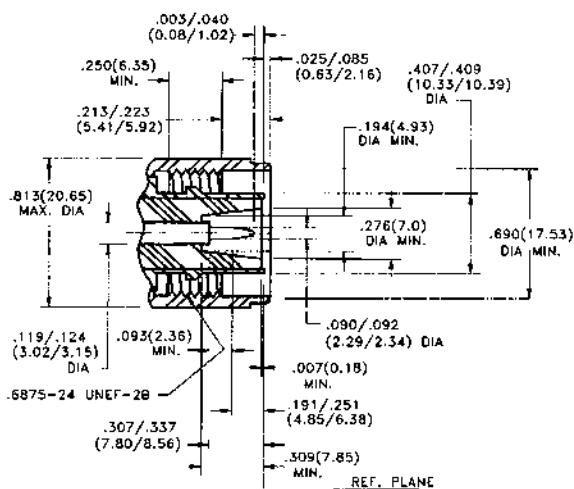

Male Plug

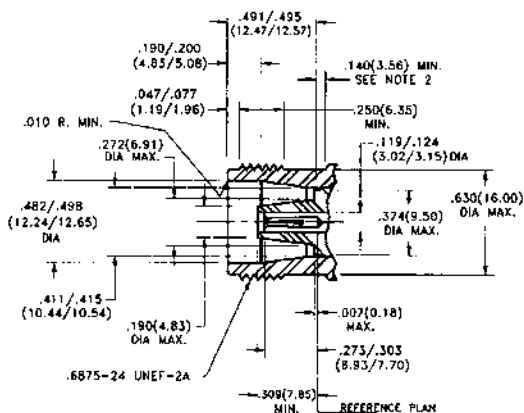

Female Jack

Type HN Interface Mating Dimensions

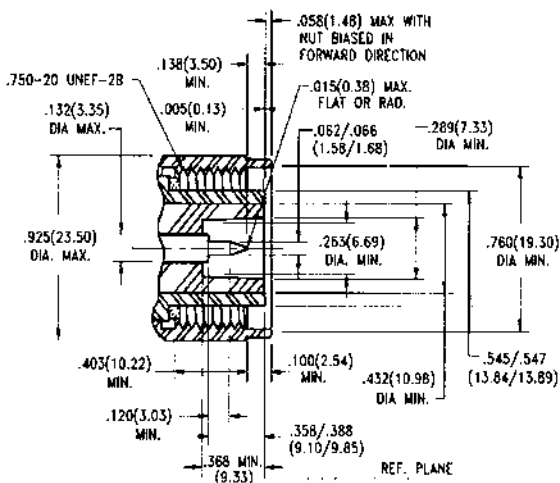

Male Plug

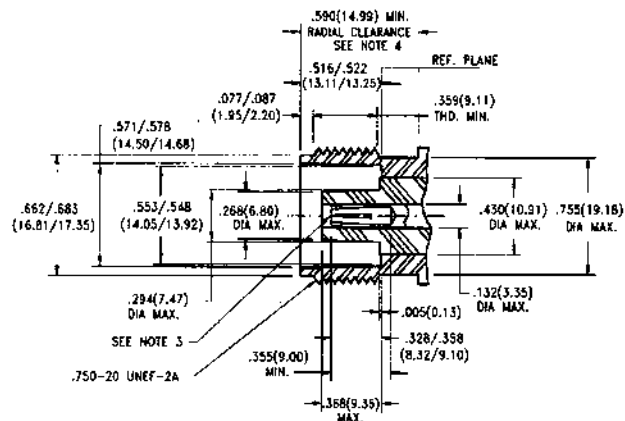

Female Jack

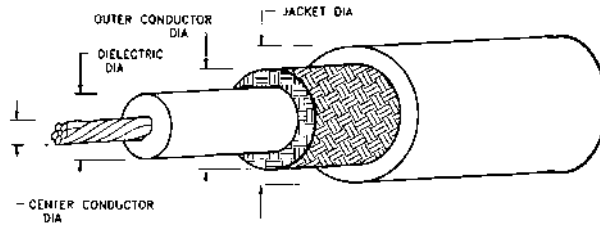

Cable Type	RG55/U	RG58/U	RG141/U	RG142/U	RG174/U	RG178/U	RG179/U	RG180/U	RG187/U	RG188/U	RG195/U	RG196/U	RG214/U	RG223/U	RG303/U	RG316/U
Impedance (Ohms)	53.5	50	50	50	50	50	75	95	75	50	95	50	50	50	50	50
Jacket Diameter	.216 max	.195±.004	.190±.005	.195±.005	.100±.005	.075 max	.100±.005	.145 max	.110 max	.110 max	.155max	.080 max	.425±.007	.2165max	.170±.005	.102 max
Outer Conductor Diameter	.176 max	.150 max	.146 max	.171 max	.088 max	.054 max	.084 max	.124max	.084 max	.081 max	.124 max	.054 max	.360 max	.176 max	.146 max	.081 max
Dielectric Diameter	.116±.005	.116±.004	.116±.005	.116±.005	.080±.003	.034±.002	.036±.003	.102±.003	.060±.003	.060±.003	.102±.003	.034±.002	.285±.003	.116±.004	.1160±.005	.060±.003
Center Conductor Diameter	.032 nom	.0375 nom	.039±.001	.039±.001	.020 nom	.012 nom	.012 nom	.012 nom	.012 nom	.020 nom	.012 nom	.012 nom	.089±.001	.035±.001	.039±.001	.020 nom

RG/U	Attenuation – dB per 100 ft. at Frequency (GHz)							Power – Watts maximum at Frequency (GHz)						
	.1	.2	.4	1	3	5	10	.1	.2	.4	1	3	5	10
55	4.8	7.0	10.0	16.5	30.5	46.0	>100.0	480	320	215	120	60	40	-
58	4.6	6.9	10.6	17.5	37.5	60.0	>100.0	300	200	135	80	40	20	-
141	3.9	5.6	8.0	13.5	27.0	39.0	70.0	1,700	1,200	830	450	220	140	65
142	3.9	5.6	8.0	13.5	27.0	39.0	70.0	1,800	1,300	800	530	265	175	100
174	8.9	12.0	17.5	30.0	64.0	99.0	>100.0	110	80	60	35	15	10	-
178	14.0	19.0	28.0	46.0	85.0	>100.0	>100.0	240	180	120	75	40	-	-
179	10.0	12.5	16.0	24.0	44.0	65.0	>100.0	480	420	320	190	100	73	-
180	5.7	7.5	10.8	17.0	35.0	50.0	88.0	800	570	400	240	130	90	50
187	10.0	12.5	16.0	24.0	44.0	69.0	>100.0	480	420	320	190	100	73	-
188	11.4	14.2	16.7	31.0	60.0	82.0	>100.0	400	325	275	150	80	55	-
195	5.7	7.6	10.8	17.0	35.0	50.0	88.0	800	570	400	240	130	90	50
196	14.0	19.0	28.0	46.0	85.0	>100.0	>100.0	240	180	120	75	40	-	-
214	2.3	3.3	5.0	8.8	18.0	27.0	45.0	780	550	360	200	100	65	40
223	4.8	7.0	10.0	16.5	30.5	46.0	>100.0	480	320	215	120	60	40	-
303	3.9	5.6	8.0	13.5	27.0	39.0	70.0	1,800	1,300	900	500	265	175	100
316	11.4	14.2	16.7	31.0	60.0	82.0	>100.0	400	325	275	150	80	55	-

VSWR vs. Return Loss Table

VSWR	R. L. (dB)	VSWR	R. L. (dB)	VSWR	R. L. (dB)	VSWR	R. L. (dB)	VSWR	R. L. (dB)
1.001	66.025	1.060	30.714	1.138	23.803	1.480	14.264	5.400	3.255
1.002	60.009	1.061	30.575	1.140	23.686	1.490	14.120	5.600	3.136
1.003	56.491	1.062	30.438	1.142	23.571	1.500	13.979	5.800	3.025
1.004	53.997	1.063	30.303	1.144	23.457	1.520	13.708	6.000	2.923
1.005	52.063	1.064	30.171	1.146	23.346	1.540	13.449	6.200	2.827
1.006	50.484	1.065	30.040	1.148	23.235	1.560	13.201	6.400	2.737
1.007	49.149	1.066	29.912	1.150	23.127	1.580	12.964	6.600	2.653
1.008	47.993	1.067	29.785	1.152	23.020	1.600	12.736	6.800	2.573
1.009	46.975	1.068	29.661	1.154	22.914	1.620	12.518	7.000	2.499
1.010	46.064	1.069	29.538	1.156	22.810	1.640	12.308	7.200	2.428
1.011	45.240	1.070	29.417	1.158	22.708	1.660	12.107	7.400	2.362
1.012	44.489	1.071	29.298	1.160	22.607	1.680	11.913	7.600	2.299
1.013	43.798	1.072	29.181	1.162	22.507	1.700	11.725	7.800	2.239
1.014	43.159	1.073	29.066	1.164	22.408	1.720	11.545	8.000	2.183
1.015	42.564	1.074	28.952	1.166	22.311	1.740	11.370	8.200	2.129
1.016	42.007	1.075	28.839	1.168	22.215	1.760	11.202	8.400	2.078
1.017	41.485	1.076	28.728	1.170	22.120	1.780	11.039	8.600	2.029
1.018	40.993	1.077	28.619	1.172	22.027	1.800	10.881	8.800	1.983
1.019	40.528	1.078	28.511	1.174	21.934	1.820	10.729	9.000	1.938
1.020	40.086	1.079	28.405	1.176	21.843	1.840	10.581	9.200	1.896
1.021	39.667	1.080	28.299	1.178	21.753	1.860	10.437	9.400	1.855
1.022	39.867	1.081	28.196	1.180	21.664	1.880	10.298	9.600	1.816
1.023	38.885	1.082	28.093	1.182	21.576	1.900	10.163	9.800	1.779
1.024	38.520	1.083	27.992	1.184	21.489	1.920	10.032	10.000	1.743
1.025	38.170	1.084	27.892	1.186	21.403	1.940	9.904	11.000	1.584
1.026	37.833	1.085	27.794	1.188	21.318	1.960	9.780	12.000	1.451
1.027	37.510	1.086	27.696	1.190	21.234	1.980	9.660	13.000	1.339
1.028	37.198	1.087	27.600	1.192	21.151	2.000	9.542	14.000	1.243
1.029	36.898	1.088	27.505	1.194	21.069	2.100	8.999	15.000	1.160
1.030	36.607	1.089	27.411	1.196	20.988	2.200	8.519	16.000	1.087
1.031	36.327	1.090	27.318	1.198	20.907	2.300	8.091	17.000	1.023
1.032	36.055	1.091	27.226	1.200	20.828	2.400	7.707	18.000	0.966
1.033	35.792	1.092	27.135	1.210	20.443	2.500	7.360	19.000	0.915
1.034	35.537	1.093	27.046	1.220	20.079	2.600	7.044	20.000	0.869
1.035	35.290	1.094	26.957	1.230	19.732	2.700	6.755	22.000	0.790
1.036	35.049	1.095	26.869	1.240	19.401	2.800	6.490	24.000	0.724
1.037	34.816	1.096	26.782	1.250	19.085	2.900	6.246	26.000	0.668
1.038	34.588	1.097	26.697	1.260	18.783	3.000	6.021	28.000	0.621
1.039	34.367	1.098	26.612	1.270	18.493	3.100	5.811	30.000	0.579
1.040	34.151	1.099	26.528	1.280	18.216	3.200	5.617	32.000	0.543
1.041	33.941	1.100	26.444	1.290	17.949	3.300	5.435	34.000	0.511
1.042	33.763	1.102	26.281	1.300	17.692	3.400	5.265	36.000	0.483
1.043	33.536	1.104	26.120	1.310	17.445	3.500	5.105	38.000	0.457
1.044	33.341	1.106	25.963	1.320	17.207	3.600	4.956	40.000	0.434
1.045	33.150	1.108	25.809	1.330	16.977	3.700	4.815	42.000	0.414
1.046	32.963	1.110	25.658	1.340	16.755	3.800	4.682	44.000	0.395
1.047	32.780	1.112	25.510	1.350	16.540	3.900	4.556	46.000	0.378
1.048	32.602	1.114	25.364	1.360	16.332	4.000	4.437	48.000	0.362
1.049	32.427	1.116	25.221	1.370	16.131	4.100	4.324	50.000	0.347
1.050	32.256	1.118	25.081	1.380	15.936	4.200	4.217	55.000	0.316
1.051	32.088	1.120	24.943	1.390	15.747	4.300	4.115	60.000	0.290
1.052	31.923	1.122	24.808	1.400	15.563	4.400	4.018	65.000	0.267
1.053	31.762	1.124	24.675	1.410	15.385	4.500	3.926	70.000	0.248
1.054	31.604	1.126	24.544	1.420	15.211	4.600	3.838	75.000	0.232
1.055	31.449	1.128	24.415	1.430	15.043	4.700	3.753	80.000	0.217
1.056	31.297	1.130	24.289	1.440	14.879	4.800	3.673	85.000	0.204
1.057	31.147	1.132	24.164	1.450	14.719	4.900	3.596	90.000	0.193
1.058	31.000	1.134	24.042	1.460	14.564	5.000	3.522	95.000	0.183
1.059	30.856	1.136	23.921	1.470	14.412	5.200	3.383	100.000	0.174

Emerson Network Power Connectivity Solutions has used the guidelines of MIL-HDBK-5400 and MIL-HDBK-2036 to specify the below listed environmental condition that the standard non QPL catalog products of Midwest Microwave product line are designed to meet.

Temperature range:	Operating	-55°C to +125°C
	Non-Operating	-65°C to +125°C
Thermal Shock:	MIL-STD-202G Method 107, Test Condition B, 5 cycles, -65°C to +125°C	
Vibration:	MIL-STD-202G Method 204, Test Condition B	
	.06” Double Amplitude Displacement	10 - 70 Hz
	15 G’s peak	70 - 2000 Hz
	12 cycles (10 - 2000 - 10 Hz) each axis for 20 min per cycle.	
Shock:	MIL-STD-202G Method 213, Test Condition J	
	1/2 Sine, 30 G’s, 11 millisecond duration.	
	3 shock pulses in each direction along 3 ⊥ axis. Total 18 pulses	
Humidity:	MIL-STD-202G Method 106, Except for steps 7a & 7b	
	98% relative humidity, 25°C to 65°C, 10 cycles, 240 Hrs	
Salt Spray: (Corrosion)	MIL-STD-202G Method 101, Test Condition B (48 Hrs)	
Temperature / Altitude:	70,000 ft. -65°C to +115°C	
	1. +25°C	1 Atm. Stabilized
	2. -65°C	1 Atm. 1 Hour cold soak
	3. -55°C	70,000 ft. Stabilized
	4. -10°C	1 Atm. Form frost
	5. +115°C	70,000 ft. 1 Hour hot soak
	6. +25°C	1 Atm. Stabilized
RFI Leakage:	-40 dBc	

Requirements other than those specified above need to be reviewed on a case-by-case basis. Midwest Microwave products have routinely met environmental requirements more severe than noted above, but in each case they were treated as custom parts with specially assigned custom part numbers. Please contact customer service to inquire about any custom requirements.

Space Qualified Parts

Emerson Network Power Connectivity Solutions custom manufactures Midwest Microwave line of High Reliability (Hi-Rel) products suitable for use under space flight conditions. These products are manufactured using a system that provides complete traceability of all of the piece parts that make up their assembly. All materials used meet or exceed the 1% TML and 0.1% CVCM requirements as tested per ASTM E595.

Hi-Rel parts are manufactured to individual customer specifications and undergo extensive testing as required by the customer. Example below shows how a space rated attenuator inspection and testing requirements may look like.

In-Process Inspections	Sample Size	Group A Inspections – 100%	Group B Inspections – 100%
Visual & Mechanical Dimensions	100%	Visual & Mechanical Inspection	Electrical Characteristics @ Operating Temperature Extremes
Plating Thickness	5 pcs	Thermal Shock	Contact Engaging/Separating Forces
Solderability	5 pcs	Sinusoidal Vibration	Coupling Mechanism Proof Torque
Plating Adhesion	5 pcs	Electrical Characteristics	Connector Mounting Proof Torque
Contact Captivation	100%	Peak Power	
Rotational Contact Retention	6 pcs	Connector Engaging/Separating Force	Group C Inspections - 100%
Axial Contact Retention	6 pcs	Radiographic Inspections	Vibration
Proof Torque	100%		Shock
Contact Engaging Force	100%		Moisture Resistance
Contact Separating Force	100%		Electrical Characteristics
			Resistance to Solvents

General Part Number Logic*

ATT - **0263** - **XX** - **SMA** - **02**

PART IDENTIFIER

- ADT..... Adapter
- ATT Attenuator
- CPL..... Directional Coupler
- DCB DC Block
- EQL..... Equalizer
- HYB Hybrid Coupler
- PWD Power Divider
- TRM Termination

SERIES
Nonspecific

PART SPECIFIC DESCRIPTION

- ADT..... Interface
- ATT dB Value
- CPL..... dB coupling
- EQL..... Slope
- PWD Power divisions
- TRM Gender

INTERFACE
Numerical = custom part

FINISH

- 00..... Gold Plated over
- Stainless Steel
- 02..... Passivated
- Stainless Steel
- 07 Anodized Aluminum
- 10..... Nickel Plated Brass
- 79..... MIL-Spec Gray Paint

* Does not apply to connectors and QPL parts.

Model No.	Page No.	Model No.	Page No.	Model No.	Page No.	Model No.	Page No.
2.9 mm Connectors		ADT-2576-NM-SMM-02 98	ADT-2675-7M-SMM-02 89	ADT-2791-NM-HNF-02..... 107			
29M-0085-79-000-02 162		ADT-2577-NM-SMF-02 98	ADT-2676-7M-SMF-02 89	ADT-2793-TF-SMF-02..... 109			
29M-0085-89-000-02 162		ADT-2578-MF-008-02 198	ADT-2676-MF-001-02 197	ADT-2797-SF-BMM-02 114			
29M-5572-12-DRP-02 162		ADT-2578-MF-010-02 198	ADT-2677-7M-SMM-02 92	ADT-2798-SM-BMM-02 114			
29M-5572-15-DRP-02 162		ADT-2578-NF-SMM-02 98	ADT-2678-7M-SMF-02 92	ADT-2801-7M-HNM-02.....95			
29M-5573-12-DRP-02 162		ADT-2579-FF-016-02 198	ADT-2680-NM-SMM-02 101	ADT-2802-7M-HNF-0295			
29M-5573-15-DRP-02 162		ADT-2579-FF-017-02 198	ADT-2681-NM-SMF-02 102	ADT-2803-NM-HNM-02 107			
29M-5574-12-DRP-02 162		ADT-2579-NF-SMF-02 98	ADT-2682-NF-SMM-02 102	ADT-2804-NF-HNM-02..... 107			
29M-5574-15-DRP-02 162		ADT-2580-MM-002-02 197	ADT-2683-FF-002-02 197	ADT-2805-SF-BMF-02..... 113			
29M-5575-12-DRP-02 162		ADT-2580-NM-SMM-02 97	ADT-2683-NF-SMF-02 102	ADT-2806-SF-BMM-02 113			
29M-5575-15-DRP-02 162		ADT-2581-NM-SMF-02 97	ADT-2685-TM-SMM-02 108	ADT-2807-SM-BMF-02 113			
		ADT-2582-NF-SMM-02 97	ADT-2686-TM-SMF-02 108	ADT-2808-NM-SMF-02 115			
		ADT-2583-NF-SMF-02 97	ADT-2687-TF-SMM-02 108	ADT-2809-NF-SMM-02 115			
3.5 mm Connectors		ADT-2584-NM-TNM-02 104	ADT-2688-TF-SMF-02..... 108	ADT-2810-NF-SMM-0299			
35M-2725-79-141-02 161		ADT-2585-NM-TNF-02 104	ADT-2689-TF-SMM-02 109	ADT-2811-NM-SSM-02..... 101			
35M-2726-83-141-02 161		ADT-2586-NF-TNM-02 104	ADT-2690-NM-SSM-02..... 100	ADT-2812-NM-SSF-02 101			
35M-5572-15-DRP-02 161		ADT-2587-NF-TNF-02..... 104	ADT-2691-NM-SSF-02 100	ADT-2813-NF-SSM-02 101			
35M-5573-15-DRP-02 161		ADT-2588-MF-NNN-02..... 121	ADT-2692-NF-SSM-02 100	ADT-2814-NF-SSF-02 101			
35M-5574-15-DRP-02 161		ADT-2589-MM-NNN-02 121	ADT-2693-NF-SSF-02 100	ADT-2815-TF-SMM-02 109			
35M-5575-15-DRP-02 161		ADT-2590-FF-NNN-02 121	ADT-2694-MF-NNN-02..... 126	ADT-2816-NM-SSM-02..... 103			
35M-5972-12-DRP-02 161		ADT-2591-7M-SCM-02 94	ADT-2695-SM-SSM-02 111	ADT-2817-NM-SSF-02 103			
35M-5973-12-DRP-02 161		ADT-2592-7M-SCF-02 94	ADT-2696-SM-SSF-02 111	ADT-2818-NF-SSM-02 103			
35M-5974-12-DRP-02 161		ADT-2593-MF-SMA-02 117	ADT-2697-SF-SSM-02..... 111	ADT-2819-NF-SSF-02 103			
35M-5975-12-DRP-02 161		ADT-2594-MM-SMA-02..... 117	ADT-2698-SF-SSF-02 111	ADT-2820-MF-HN0-02 125			
		ADT-2595-FF-SMA-02 117	ADT-2699-FF-012-02 197	ADT-2821-FF-HN0-02 125			
		ADT-2596-MF-TNC-02..... 122	ADT-2699-FF-022-02 197	ADT-2822-FF-HN0-02 125			
7 mm Connectors		ADT-2597-MM-TNC-02 122	ADT-2699-TF-SMF-02..... 109	ADT-2823-FF-SMA-02..... 117			
7MM-2141-88-SEX-02..... 164		ADT-2598-FF-TNC-02..... 122	ADT-2701-7M-3MM-02.....90	ADT-2824-FF-SMA-02..... 118			
7MM-2141-89-SEX-02..... 164		ADT-2599-FF-005-02 198	ADT-2702-7M-3MF-0290	ADT-2825-FF-NNN-02 121			
7MM-2325-88-SEX-02..... 164		ADT-2599-NF-SMF-02 99	ADT-2703-7M-SSM-0291	ADT-2826-FF-TNC-02..... 122			
7MM-2325-89-SEX-02..... 164		ADT-2599-NF-SMM-02 99	ADT-2704-7M-SSF-0291	ADT-2828-MF-BNC-10 123			
7MM-2602-7M-HEX-02 164		ADT-2603-7M-NNM-02 93	ADT-2705-7M-SSM-0292	ADT-2829-FF-BNC-10..... 123			
7MM-2708-00-141-02 164		ADT-2604-7M-NNF-02 93	ADT-2706-7M-SSF-0292	ADT-2830-MM-BNC-10 123			
7MM-2711-15-TRM-02 164		ADT-2613-NM-BNM-02 105	ADT-2712-NM-3MM-0296	ADT-2831-FF-BNC-10..... 123			
7MM-2842-00-250-02 164		ADT-2614-NM-BNF-02 105	ADT-2713-NM-3MF-02.....96	ADT-2832-MF-SCO-02 124			
		ADT-2615-NF-BNM-02 105	ADT-2714-NF-3MM-02.....96	ADT-2833-FF-SCO-02..... 124			
		ADT-2616-NF-BNF-02 105	ADT-2715-NF-3MF-02.....96	ADT-2834-MM-SCO-02 124			
		ADT-2618-NM-SCM-02 106	ADT-2733-MF-3MM-02 119	ADT-2835-FF-SCO-02..... 124			
		ADT-2619-NF-SCM-02..... 106	ADT-2734-MM-3MM-02 119	ADT-2837-TF-SMF-02..... 126			
		ADT-2638-NM-SCF-02..... 106	ADT-2735-FF-3MM-02 119	ADT-2838-BF-SMF-02..... 126			
		ADT-2639-NF-SCF-02 106	ADT-2742-7M-3MM-02.....92	ADT-2840-NF-SMF-02 99			
		ADT-2653-7M-SMF-02 90	ADT-2743-7M-3MF-0292	ADT-2845-SF-MMF-02..... 112			
		ADT-2655-7M-SMM-02 90	ADT-2744-MM-HN0-02..... 125	ADT-2846-SM-MMF-02 112			
		ADT-2656-7M-SSM-02 91	ADT-2761-7M-BMM-02.....95	ADT-2847-SF-MMM-02 112			
		ADT-2657-7M-SSF-02 91	ADT-2762-7M-BMF-0295	ADT-2848-SM-MMM-02 112			
		ADT-2667-00-7MM-02..... 126	ADT-2767-SF-BMF-02..... 115	ADT-2850-FF-35M-02 119			
		ADT-2670-BM-SMM-02 110	ADT-2768-SM-BMF-02 113	ADT-2851-MF-29M-00 120			
		ADT-2671-BM-SMF-02 110	ADT-2769-SF-BMM-02 114	ADT-2852-FF-29M-00 120			
		ADT-2672-BF-SMM-02 110	ADT-2770-SM-BMM-02 114	ADT-2853-MM-29M-00 120			
		ADT-2673-BF-SMF-02..... 110	ADT-2779-FF-004-02..... 197	ADT-2854-FF-29M-02 120			
			ADT-2790-NF-HNF-02 107	ADT-8000-FF-SMA-02 118			

Model Number – Page Number

Model No.	Page No.	Model No.	Page No.	Model No.	Page No.	Model No.	Page No.
ADT-8000-MF-SMA-02	118	ATT-(0)591(F/M)-XX-SSB-10 ...	28	BMA-6859-43-STR-02	160	CPL-5210-06-SMA-79.....	65
ADT-8000-MM-SMA-02	118	ATT-(0)592(F/M)-XX-SMB-10 ..	28	BMA-6859-44-STR-02	160	CPL-5210-10-SMA-79.....	65
ATS-3551-18-NNN-02	29	ATT-(0)640(F/M)-XX-29M	6	BNC Connectors			
ATS-3552-18-7MM-02	29	Blind Mate Connectors		BNC-0085-79-000-10.....	173	CPL-5210-20-SMA-79.....	65
ATS-3554-18-SMA-02	29	BMA-0085-83-000-00	155	BNC-0085-83-000-10.....	173	CPL-5210-30-SMA-79	65
ATT-0220-XX-7MM-02	19	BMA-0085-85-000-02	155	BNC-0085-84-000-10.....	173	CPL-5211-06-SMA-79.....	65
ATT-(0)205(F/M)-XX-SMA-02..	11	BMA-0085-86-000-00	155	BNC-0141-79-000-10.....	173	CPL-5211-10-SMA-79.....	65
ATT-(0)218(F/M)-XX-NNN-02 .	20	BMA-0085-87-000-02	155	BNC-0141-83-000-10.....	173	CPL-5211-20-SMA-79.....	65
ATT-(0)219(F/M)-XX-NNN-02 .	20	BMA-0141-83-000-00	155	BNC-0141-84-000-10.....	173	CPL-5211-30-SMA-79.....	65
ATT-(0)224(F/M)-XX-TNC-02 .	24	BMA-0141-85-000-02	155	BNC-2250-79-000-10.....	173	CPL-5212-06-SMA-79.....	65
ATT-(0)225(F/M)-XX-TNC-02 .	24	BMA-0141-86-000-00	155	BNC-2250-79-HEL-10	174	CPL-5212-10-SMA-79.....	65
ATT-(0)238(F/M)-XX-SMA-02..	11	BMA-0141-87-000-02	155	BNC-2250-83-000-10.....	173	CPL-5212-20-SMA-79.....	65
ATT-(0)263(F/M)-XX-SMA-02..	11	BMA-1055-51-000-02	156	BNC-2250-83-HEL-10	174	CPL-5212-30-SMA-79.....	65
ATT-(0)275(F/M)-XX-SMA-02..	13	BMA-1055-53-000-02	156	BNC-2500-79-HEL-10	174	CPL-5213-06-SMA-79.....	65
ATT-(0)276(F/M)-XX-SMA-02..	13	BMA-1055-59-000-02	156	BNC-2500-83-HEL-10	174	CPL-5213-10-SMA-79.....	65
ATT-(0)277(F/M)-XX-SMA-02..	13	BMA-1055-61-000-02	156	BNC-3055-54-000-10.....	174	CPL-5213-20-SMA-79.....	65
ATT-(0)290(F/M)-XX-HEX-02...9		BMA-1188-51-000-02	156	BNC-3055-55-000-10.....	174	CPL-5213-30-SMA-79.....	65
ATT-(0)290(F/M)-XX-SMA-02 ..7		BMA-1188-53-000-02	156	BNC-3055-59-000-10.....	174	CPL-5214-06-SMA-79.....	65
ATT-(0)291(F/M)-XX-HEX-02...9		BMA-1188-59-000-02	156	BNC-3058-54-000-10.....	174	CPL-5214-10-SMA-79.....	65
ATT-(0)291(F/M)-XX-SMA-02 ..7		BMA-1188-61-000-02	156	BNC-3058-55-000-10.....	174	CPL-5214-20-SMA-79.....	65
ATT-(0)292(F/M)-XX-HEX-02...9		BMA-3055-51-001-02	196	BNC-3058-59-000-10.....	174	CPL-5214-30-SMA-79.....	65
ATT-(0)292(F/M)-XX-SMA-02 ..8		BMA-3055-58-001-02	196	BNC-3188-54-000-10.....	174	CPL-5215-06-SMA-79.....	65
ATT-(0)294(F/M)-XX-HEX-02...9		BMA-3055-58-002-02	196	BNC-3188-55-000-10.....	174	CPL-5215-10-SMA-79.....	65
ATT-(0)294(F/M)-XX-SMA-02 ..8		BMA-3188-51-002-02	196	BNC-3188-59-000-10.....	174	CPL-5215-20-SMA-79.....	65
ATT-(0)298(F/M)-XX-HEX-02...9		BMA-3188-58-001-02	196	BNC-5040-12-POT-10	175	CPL-5215-30-SMA-79.....	65
ATT-(0)298(F/M)-XX-SMA-02 ..7		BMA-3188-58-002-02	196	BNC-5040-19-POT-10	176	CPL-5216-06-SMA-79.....	65
ATT-(0)303(F/M)-XX-SMA-07 ..17		BMA-4085-82-001-00	196	BNC-5710-14-TRM-10.....	176	CPL-5216-10-SMA-79.....	65
ATT-(0)313(F/M)-XX-BNC-10 ..26		BMA-4085-82-002-00	196	BNC-5710-15-TRM-10.....	175	CPL-5216-20-SMA-79.....	65
ATT-(0)314(F/M)-XX-BNC-10 ..26		BMA-4085-86-001-00	196	BNC-5730-14-TAB-10	176	CPL-5216-30-SMA-79.....	65
ATT-(0)333(F/M)-XX-SMA-02..12		BMA-4141-82-001-00	196	BNC-5730-15-TAB-10.....	175	CPL-5217-06-SMA-79.....	65
ATT-0389-XX-NNN-02.....	20	BMA-4141-82-002-00	196	BNC-5740-14-POT-10	176	CPL-5217-10-SMA-79.....	65
ATT-(0)390(F/M)-XX-NNN-07 .21		BMA-4141-86-001-02	196	BNC-5740-15-POT-10	175	CPL-5217-20-SMA-79.....	65
ATT-(0)391(F/M)-XX-NNN-07 .21		BMA-5010-90-PCB-00	159	Couplers - Directional			
ATT-(0)392(F/M)-XX-NNN-07 .22		BMA-5010-91-PCB-00	159	CPL-5028-30-NNN-79	72	CPL-5217-30-SMA-79	65
ATT-(0)397(F/M)-XX-NNN-07 .22		BMA-5010-93-PCB-00	159	CPL-5044-10-NNN-79	71	CPL-5220-06-SMA-79.....	66
ATT-0431-XX-SMA-02	19	BMA-5010-94-PCB-00	159	CPL-5044-20-NNN-79	71	CPL-5220-10-SMA-79.....	66
ATT-(0)444(F/M)-XX-SMA-02..10		BMA-5012-10-TRM-02	158	CPL-5044-30-NNN-79	71	CPL-5220-16-SMA-79.....	66
ATT-(0)451(F/M)-XX-SMA-02....8		BMA-5012-12-TRM-02	158	CPL-5045-10-NNN-79	71	CPL-5220-20-SMA-79.....	66
ATT-(0)472(F/M)-XX-SMA-07..17		BMA-5018-12-TRM-02	158	CPL-5045-20-NNN-79	71	CPL-5221-06-SMA-79.....	66
ATT-(0)473(F/M)-XX-SMA-07..16		BMA-5210-14-TRM-02	157	CPL-5045-30-NNN-79	71	CPL-5221-10-SMA-79.....	66
ATT-(0)475(F/M)-XX-SMA-07..16		BMA-5210-15-TRM-02	157	CPL-5046-10-NNN-79	71	CPL-5221-16-SMA-79.....	66
ATT-(0)479(F/M)-XX-TNC-07 ..25		BMA-5510-14-TRM-02	157	CPL-5046-20-NNN-79	71	CPL-5221-20-SMA-79.....	66
ATT-(0)480(F/M)-XX-TNC-07 ..25		BMA-5510-15-TRM-02	157	CPL-5046-30-NNN-79	71	CPL-5222-06-SMA-79	66
ATT-(0)523(F/M)-XX-SMA-02..14		BMA-5918-19-TRM-02	158	CPL-5047-10-NNN-79	71	CPL-5222-10-SMA-79.....	66
ATT-(0)528(F/M)-XX-NNN-07 .23		BMA-5961-19-DRP-02.....	160	CPL-5047-20-NNN-79	71	CPL-5222-16-SMA-79.....	66
ATT-(0)547(F/M)-XX-NNN-07 ..23		BMA-5975-19-DRP-02.....	160	CPL-5047-30-NNN-79	71	CPL-5222-20-SMA-79.....	66
ATT-(0)550(F/M)-XX-35M-02..15		BMA-6856-43-STR-02	160	CPL-5048-10-NNN-79	71	CPL-5226-06-SMA-79.....	66
ATT-(0)553(F/M)-XX-SMA-07..18		BMA-6856-44-STR-02	160	CPL-5048-20-NNN-79	71	CPL-5226-10-SMA-79.....	66
ATT-(0)554(F/M)-XX-SMA-07..18		BMA-6858-43-STR-02	160	CPL-5048-30-NNN-79	71	CPL-5226-16-SMA-79.....	66
ATT-(0)581(F/M)-XX-BNC-07 ..26		BMA-6858-44-STR-02	160				
ATT-(0)590(F/M)-XX-SSM-02 ..27							

Model Number – Page Number

Model No.	Page No.	Model No.	Page No.	Model No.	Page No.	Model No.	Page No.
SMA-0141-82-2HL-00	130	SMA-5123-15-SLT-02	138	SMA-5522-14-SLT-02	138	SMA-5862-14-DRP-02	143
SMA-0141-83-000-00	130	SMA-5130-14-TAB-02	140	SMA-5522-15-SLT-02	138	SMA-5862-15-DRP-02	142
SMA-0141-84-4HL-00	130	SMA-5130-15-TAB-02	140	SMA-5523-14-SLT-02	138	SMA-5863-14-DRP-02	143
SMA-0141-92-000-02	129	SMA-5141-89-000-02	129	SMA-5523-15-SLT-02	138	SMA-5863-15-DRP-02	142
SMA-0142-54-4HL-02	131	SMA-5210-14-TRM-02	136	SMA-5530-14-TAB-02	140	SMA-5864-14-DRP-02	143
SMA-0142-55-000-02	131	SMA-5210-15-TRM-02	136	SMA-5540-14-POT-02	134	SMA-5864-15-DRP-02	142
SMA-0142-56-000-02	131	SMA-5230-14-TAB-02	139	SMA-5540-15-POT-02	133	SMA-5872-14-DRP-02	143
SMA-0142-58-2HL-02	131	SMA-5230-15-TAB-02	139	SMA-5540-16-POT-02	133	SMA-5872-15-DRP-02	142
SMA-0142-59-000-00	131	SMA-5232-14-TAB-02	139	SMA-5540-17-POT-02	134	SMA-5873-14-DRP-02	143
SMA-0188-54-4HL-02	131	SMA-5232-15-TAB-02	139	SMA-5561-14-DRP-02	142	SMA-5873-15-DRP-02	142
SMA-0188-55-000-02	131	SMA-5240-14-POT-02	134	SMA-5561-15-DRP-02	142	SMA-5874-14-DRP-02	143
SMA-0188-56-000-02	131	SMA-5240-15-POT-02	133	SMA-5562-14-DRP-02	143	SMA-5874-15-DRP-02	142
SMA-0188-58-2HL-02	131	SMA-5261-14-DRP-02	143	SMA-5562-15-DRP-02	142	SMA-5910-12-TRM-02	137
SMA-0188-59-000-00	131	SMA-5261-15-DRP-02	142	SMA-5563-14-DRP-02	143	SMA-5940-12-POT-02	135
SMA-1055-54-4HL-02	132	SMA-5320-14-SLT-02	138	SMA-5563-15-DRP-02	142	SMA-5961-12-DRP-02	146
SMA-1055-55-000-02	132	SMA-5320-15-SLT-02	138	SMA-5564-14-DRP-02	143	SMA-5974-12-DRP-02	146
SMA-1055-56-000-02	132	SMA-5321-14-SLT-02	138	SMA-5564-15-DRP-02	142		
SMA-1055-58-2HL-02	132	SMA-5321-15-SLT-02	138	SMA-5572-14-DRP-02	143		
SMA-1055-59-000-02	132	SMA-5321-15-TAB-02	140	SMA-5572-15-DRP-02	142		
SMA-1058-54-4HL-02	132	SMA-5322-14-SLT-02	138	SMA-5573-14-DRP-02	143		
SMA-1058-55-000-02	132	SMA-5322-15-SLT-02	138	SMA-5573-15-DRP-02	142		
SMA-1058-56-000-02	132	SMA-5323-14-SLT-02	138	SMA-5574-14-DRP-02	143		
SMA-1058-58-2HL-02	132	SMA-5323-15-SLT-02	138	SMA-5574-15-DRP-02	142		
SMA-1058-59-000-02	132	SMA-5330-14-TAB-02	140	SMA-5581-34-HRM-02	146		
SMA-1188-54-4HL-02	132	SMA-5330-15-TAB-02	140	SMA-5581-35-HRM-02	145		
SMA-1188-55-000-02	132	SMA-5362-14-DRP-02	143	SMA-5582-34-HRM-02	146		
SMA-1188-56-000-02	132	SMA-5362-15-DRP-02	142	SMA-5582-35-HRM-02	145		
SMA-1188-58-2HL-02	132	SMA-5363-14-DRP-02	143	SMA-5583-34-HRM-02	146		
SMA-1188-59-000-02	132	SMA-5363-15-DRP-02	142	SMA-5583-35-HRM-02	145		
SMA-4085-79-002-02	194	SMA-5364-14-DRP-02	143	SMA-5620-14-SLT-02	138		
SMA-4085-79-005-02	194	SMA-5364-15-DRP-02	202	SMA-5620-15-SLT-02	138		
SMA-4085-82-004-00	194	SMA-5372-14-DRP-02	143	SMA-5621-14-SLT-02	138		
SMA-4085-89-000-02	129	SMA-5372-15-DRP-02	142	SMA-5621-15-SLT-02	138		
SMA-4141-79-002-02	194	SMA-5373-14-DRP-02	143	SMA-5622-14-SLT-02	138		
SMA-4141-82-003-00	194	SMA-5373-15-DRP-02	142	SMA-5622-15-SLT-02	138		
SMA-4141-89-000-02	129	SMA-5374-14-DRP-02	143	SMA-5623-14-SLT-02	138		
SMA-5010-94-PCB-00	137	SMA-5374-15-DRP-02	142	SMA-5623-15-SLT-02	138		
SMA-5012-31-HRM-02	145	SMA-5430-14-TAB-02	139	SMA-5630-14-TAB-02	140		
SMA-5012-32-HRM-02	145	SMA-5430-15-TAB-02	139	SMA-5630-15-TAB-02	140		
SMA-5012-39-HRM-02	146	SMA-5432-14-TAB-02	139	SMA-5640-14-POT-02	134		
SMA-5040-11-POT-02	135	SMA-5432-15-TAB-02	139	SMA-5640-15-POT-02	133		
SMA-5040-12-POT-02	135	SMA-5510-14-TRM-02	136	SMA-5662-14-DRP-02	143		
SMA-5040-18-POT-02	135	SMA-5510-15-TRM-02	136	SMA-5662-15-DRP-02	142		
SMA-5085-89-000-02	129	SMA-5510-16-TRM-02	137	SMA-5663-14-DRP-02	143		
SMA-5120-14-SLT-02	138	SMA-5510-93-PCB-00	137	SMA-5663-15-DRP-02	142		
SMA-5120-15-SLT-02	138	SMA-5512-34-HRM-02	146	SMA-5672-14-DRP-02	143		
SMA-5121-14-SLT-02	138	SMA-5512-35-HRM-02	145	SMA-5672-15-DRP-02	142		
SMA-5121-15-SLT-02	138	SMA-5520-14-SLT-02	138	SMA-5673-14-DRP-02	143		
SMA-5122-14-SLT-02	138	SMA-5520-15-SLT-02	138	SMA-5673-15-DRP-02	142		
SMA-5122-15-SLT-02	138	SMA-5521-14-SLT-02	138	SMA-5674-14-DRP-02	143		
SMA-5123-14-SLT-02	138	SMA-5521-15-SLT-02	138	SMA-5674-15-DRP-02	142		

SMM - Microminiature Connectors

SMM-0034-79-000-00	151
SMM-0034-80-000-00	151
SMM-0034-83-000-00	151
SMM-0034-84-000-00	151
SMM-0047-79-000-00	151
SMM-0047-80-000-00	151
SMM-0047-83-000-00	151
SMM-0047-84-000-00	151
SMM-1196-54-000-00	151
SMM-1196-55-000-00	151
SMM-1196-56-000-00	151
SMM-1196-59-000-00	151
SMM-5010-93-PCB-00	152
SMM-5010-94-PCB-00	152
SMM-5019-11-TRM-00	152
SMM-5819-15-TRM-00	152

SSMA Sub-Miniature Connectors

SSM-0085-79-000-00	147
SSM-0085-79-001-02	195
SSM-0085-80-000-02	147
SSM-0085-80-001-02	195
SSM-0085-83-000-00	147
SSM-0085-83-001-00	195
SSM-0085-84-000-00	147
SSM-0085-92-000-00	147
SSM-1188-54-000-02	148
SSM-1188-55-000-02	148
SSM-1188-56-000-02	148

Emerson Network Power Connectivity Solutions, Inc.,
including its subsidiaries Stratos International, Inc., Trompeter Electronics, Inc., and Semflex, Inc.

TERMS AND CONDITIONS OF SALE

Emerson Network Power Connectivity Solutions, Inc. is herein referred to as the "Seller" and the customer or person or entity purchasing goods ("Goods") from Seller is referred to as the "Buyer." These Terms and Conditions, any price list or schedule, quotation, acknowledgment or invoice from Seller relevant to the sale of the Goods and all documents incorporated by specific reference herein or therein, constitute the complete and exclusive statement of the terms of the agreement governing the sale of Goods by Seller to Buyer. Buyer's acceptance of the Goods will manifest Buyer's assent to these Terms and Conditions. Seller reserves the right in its sole discretion to refuse orders.

1. PRICES: Unless otherwise specified in writing by Seller, the price quoted or specified by Seller for the Goods shall remain in effect for thirty (30) days after the date of Seller's quotation or acknowledgment of Buyer's order for the Goods, whichever occurs first, provided an unconditional authorization from Buyer for the shipment of the Goods is received and accepted by Seller within such time period. If such authorization is not received by Seller within such thirty (30) day period, Seller shall have the right to change the price for the Goods to Seller's price for the Goods at the time of shipment. All prices are exclusive of taxes, transportation and insurance, which are to be borne by Buyer.

2. TAXES: Any current or future tax or governmental charge (or increase in same) affecting Seller's costs of production, sale, or delivery or shipment, or which Seller is otherwise required to pay or collect in connection with the sale, purchase, delivery, storage, processing, use or consumption of Goods, shall be for Buyer's account and shall be added to the price.

3. TERMS OF PAYMENT: Unless otherwise specified by Seller, terms are net thirty (30) days from date of Seller's invoice in U.S. currency. Seller shall have the right, among other remedies, either to terminate this agreement or to suspend further performance under this and/or other agreements with Buyer in the event Buyer fails to make any payment when due, which other agreements Buyer and Seller hereby amend accordingly. Buyer shall be liable for all expenses, including attorneys' fees, relating to the collection of past due amounts. If any payment owed to Seller is not paid when due, it shall bear interest, at a rate to be determined by Seller, which shall not exceed the maximum rate permitted by law, from the date on which it is due until it is paid. Should Buyer's financial responsibility become unsatisfactory to Seller, cash payments or security satisfactory to Seller may be required by Seller for future deliveries and for the Goods theretofore delivered. If such cash payment or security is not provided, in addition to Seller's other rights and remedies, Seller may discontinue deliveries.

4. SHIPMENT AND DELIVERY: While Seller will use all reasonable commercial efforts to maintain the delivery date(s) acknowledged or quoted by Seller, all shipping dates are approximate and not guaranteed. Seller reserves the right to make partial shipments. Seller, at its option, shall not be bound to tender delivery of any Goods for which Buyer has not provided shipping instructions and other required information. If the shipment of the Goods is postponed or delayed by Buyer for any reason, Buyer agrees to reimburse Seller for any and all storage costs and other additional expenses resulting therefrom. Risk of loss and legal title to the Goods shall transfer to Buyer for sales in which the end destination of the Goods is outside of the United States immediately after the Goods have passed beyond the territorial limits of the United States. For all other shipments, risk of loss for damage and responsibility shall pass from Seller to Buyer upon delivery to and receipt by carrier at Seller's shipping point. All shipments are F.O.B. Seller's shipping point. Any claims for shortages or damages suffered in transit are the responsibility of Buyer and shall be submitted by Buyer directly to the carrier.

Shortages or damages must be identified and signed for at the time of delivery. Buyer shall inspect Goods delivered to it by Seller immediately upon receipt, and, any course of dealing to the contrary notwithstanding, failure of Buyer to give Seller notice of any claim within 30 days after receipt of such Goods shall be an unqualified acceptance of such Goods.

5. LIMITED WARRANTY: Subject to the limitations of Section 6, Seller warrants that the Goods manufactured by Seller will be free from defects in material and workmanship under normal use and regular service and maintenance for a period of one year from the date of shipment of the Goods by Seller, unless otherwise specified by Seller in writing. **THIS IS THE SOLE AND EXCLUSIVE WARRANTY GIVEN BY SELLER WITH RESPECT TO THE GOODS AND IS IN LIEU OF AND EXCLUDE ALL OTHER WARRANTIES, EXPRESS OR IMPLIED, ARISING BY OPERATION OF LAW OR OTHERWISE, INCLUDING WITHOUT LIMITATION, MER-**

CHANTABILITY AND FITNESS FOR A PARTICULAR PURPOSE WHETHER OR NOT THE PURPOSE OR USE HAS BEEN DISCLOSED TO SELLER IN SPECIFICATIONS, DRAWINGS OR OTHERWISE, AND WHETHER OR NOT SELLER'S PRODUCTS ARE SPECIFICALLY DESIGNED AND/OR MANUFACTURED BY SELLER FOR BUYER'S USE OR PURPOSE.

This warranty does not extend to any losses or damages due to misuse, accident, abuse, neglect, normal wear and tear, negligence (other than Seller's), unauthorized modification or alteration, use beyond rated capacity, unsuitable power sources or environmental conditions, improper installation, repair, handling, maintenance or application or any other cause not the fault of Seller. To the extent that Buyer or its agents has supplied specifications, information, representation of operating conditions or other data to Seller in the selection or design of the Goods and the preparation of Seller's quotation, and in the event that actual operating conditions or other conditions differ from those represented by Buyer, any warranties or other provisions contained herein which are affected by such conditions shall be null and void.

If within thirty (30) days after Buyer's discovery of any warranty defects within the warranty period, Buyer notifies Seller thereof in writing, Seller shall, at its option and as Buyer's exclusive remedy, repair, correct or replace F.O.B. point of manufacture, or refund the purchase price for, that portion of the Goods found by Seller to be defective. Failure by Buyer to give such written notice within the applicable time period shall be deemed an absolute and unconditional waiver of Buyer's claim for such defects. All costs of dismantling, reinstallation and freight and the time and expense of Seller's personnel and representatives for site travel and diagnosis under this warranty shall be borne by Buyer unless accepted in writing by Seller. Goods repaired or replaced during the warranty period shall be covered by the foregoing warranty for the remainder of the original warranty period or ninety (90) days from the date of shipment, whichever is longer.

Buyer assumes all other responsibility for any loss, damage, or injury to persons or property arising out of, connected with, or resulting from the use of Goods, either alone or in combination with other products/components.

Section 5 applies to any entity or person who may buy, acquire or use the Goods, including any entity or person who obtains the Goods from Buyer, and shall be bound by the limitations therein, including Section 6. Buyer agrees to provide such subsequent transferee conspicuous, written notice of the provisions of Sections 5 and 6.

6. LIMITATION OF REMEDY AND LIABILITY: THE SOLE AND EXCLUSIVE REMEDY FOR BREACH OF ANY WARRANTY HEREUNDER OTHER THAN THE WARRANTY PROVIDED UNDER SECTION 7 SHALL BE LIMITED TO REPAIR, CORRECTION OR REPLACEMENT, OR REFUND OF THE PURCHASE PRICE UNDER SECTION 5.

SELLER SHALL NOT BE LIABLE FOR DAMAGES CAUSED BY DELAY IN PERFORMANCE AND THE REMEDIES SET FORTH IN THIS AGREEMENT ARE EXCLUSIVE. IN NO EVENT, REGARDLESS OF THE FORM OF THE CLAIM OR CAUSE OF ACTION (WHETHER BASED IN CONTRACT, INFRINGEMENT, NEGLIGENCE, STRICT LIABILITY, OTHER TORT OR OTHERWISE), SHALL SELLER'S LIABILITY TO BUYER AND/OR ITS CUSTOMERS EXCEED THE PRICE PAID BY BUYER FOR THE SPECIFIC GOODS PROVIDED BY SELLER GIVING RISE TO THE CLAIM OR CAUSE OF ACTION. BUYER AGREES THAT IN NO EVENT SHALL SELLER'S LIABILITY TO BUYER AND/OR ITS CUSTOMERS EXTEND TO INCLUDE INCIDENTAL, CONSEQUENTIAL OR PUNITIVE DAMAGES. The term "consequential damages" shall include, but not be limited to, loss of anticipated profits, business interruption, loss of use, revenue, reputation and data, costs incurred, including without limitation, for capital, fuel, power and loss or damage to property or equipment.

Buyer expressly acknowledges and agrees that Seller has set its prices and entered into this agreement in reliance upon the limitations of liability and other terms and conditions specified herein, which allocates the risk between Seller and Buyer and form a basis of this bargain between the parties.

It is expressly understood that any technical advice furnished by Seller with respect to the use of the Goods is given without charge, and Seller assumes no obligation or liability for the advice given, or results obtained, all such advice being given and accepted at Buyer's risk.

7. PATENTS AND COPYRIGHTS: Subject to the limitations of the second

paragraph of Section 6, Seller warrants that the Goods sold, except as are made specifically for Buyer according to Buyer's specifications, do not infringe any valid U.S. patent or copyright in existence as of the date of shipment. This warranty is given upon the condition that Buyer promptly notify Seller of any claim or suit involving Buyer in which such infringement is alleged and cooperate fully with Seller and permit Seller to control completely the defense, settlement or compromise of any such allegation of infringement. Seller's warranty as to use patents only applies to infringement arising solely out of the inherent operation according to Seller's specifications and instructions (i) of such Goods, or (ii) of any combination of Goods acquired from Seller in a system designed by Seller. In the event such Goods are held to infringe such a U.S. patent or copyright in such suit, and the use of such Goods is enjoined, or in the case of a compromise or settlement by Seller, Seller shall have the right, at its option and expense, to procure for Buyer the right to continue using such Goods, or replace them with non-infringing Goods, or modify same to become non-infringing, or grant Buyer a credit for the depreciated value of such Goods and accept return of them. In the event of the foregoing, Seller may also, at its option, cancel the agreement as to future deliveries of such Goods, without liability.

8. EXCUSE OF PERFORMANCE: Seller shall not be liable for delays in performance or for non-performance due to acts of God; acts of Buyer; war; fire; flood; weather; sabotage; strikes or labor disputes; civil disturbances or riots; governmental requests, restrictions, allocations, laws, regulations, orders or actions; unavailability of or delays in transportation; default of suppliers; or unforeseen circumstances or any events or causes beyond Seller's reasonable control. Deliveries or other performance may be suspended for an appropriate period of time or canceled by Seller upon notice to Buyer in the event of any of the foregoing, but the balance of the agreement shall otherwise remain unaffected as a result of the foregoing.

If Seller determines that its ability to supply the total demand for the Goods, or to obtain material used directly or indirectly in the manufacture of the Goods, is hindered, limited or made impracticable due to causes set forth in the preceding paragraph, Seller may allocate its available supply of the Goods or such material without obligation to acquire other supplies of any such Goods or material among itself and its purchasers on such basis as Seller determines to be equitable without liability for any failure of performance which may result therefrom.

9. CANCELLATION: Unless otherwise agreed in writing by Seller, orders under this agreement may not be canceled by Buyer for any reason.

10. CHANGES: Buyer may request changes or additions to the Goods consistent with Seller's specifications and criteria. In the event such changes or additions are accepted by Seller, Seller may revise the price and dates of delivery.

Seller reserves the right to change designs and specifications for the Goods without prior notice to Buyer, except with respect to Goods being made-to-order for Buyer. Seller shall have no obligation to install or make such change in any Goods manufactured prior to the date of such change.

11. NUCLEAR/MEDICAL. GOODS AND SERVICES SOLD HEREUNDER ARE NOT FOR USE IN CONNECTION WITH ANY NUCLEAR, MEDICAL, LIFESUPPORT AND RELATED APPLICATIONS. Buyer accepts goods and services with the foregoing understanding, agrees to communicate the same in writing to any subsequent purchasers or users and to defend, indemnify and hold harmless Seller from any claims, losses, suits, judgments and damages, including incidental and consequential damages, arising from such use, whether the cause of action be based in tort, contract or otherwise, including allegations that the Seller's liability is based on negligence or strict liability.

12. BUYER'S COMPLIANCE WITH LAWS: In connection with the transactions contemplated by this agreement, Buyer is familiar with and shall fully comply with all applicable laws, regulations, rules and other requirements of the United States and of any applicable state, foreign and local governmental body in connection with the purchase, receipt, use, transfer and disposal of the Goods.

13. EXPORT/IMPORT: Buyer agrees that all applicable import and export control laws, regulations, orders and requirements, including without limitation those of the United States and the European Union, and the jurisdictions in which the Seller and Buyer are established or from which Goods and Services may be supplied, will apply to their receipt and use. In no event shall Buyer use, transfer, release, import, export, Goods in violation of such applicable laws, regulations, orders or requirements.

14. TOOLING: Tool, die, and pattern charges, if any, are in addition to the price of the Goods and are due and payable upon completion of the tool-

ing. All such tools, dies and patterns shall be and remain the property of Seller. Charges for tools, dies, and patterns do not convey to Buyer, title, ownership interest in, or rights to possession or removal, or prevent their use by Seller for other purchasers, except as otherwise expressly provided by Seller and Buyer in writing with reference to this provision.

15. RETURNED GOODS: Except as otherwise provided with respect to warranty defects in Section 5, advance written permission to return Goods must be obtained from Seller's customer service department. Such Goods must be current, unused, catalogued Goods and must be shipped, transportation prepaid, to the Seller's specified return location. Returns made without proper written permission will not be accepted by Seller. Credit or exchange for such returned Goods will be at the billing price or current price, whichever is lower, from which will be deducted an inspection, restocking and repacking charge and the cost of any reconditioning. Seller reserves the right to inspect Goods prior to authorizing return.

16. BUYER SUPPLIED DATA: To the extent that Seller has been provided by or on behalf of Buyer any specifications, description of operating conditions or other data and information in connection with the selection or design of the Goods, and the actual operating conditions or other circumstances differ from those provided by Buyer and relied upon by Seller, any warranties or other provisions contained herein which are affected by such conditions shall be null and void.

17. SOFTWARE¹: Notwithstanding any other provision herein to the contrary, Seller or applicable third party licensor to Seller shall retain all rights of ownership and title in its respective Software, including without limitation all rights of ownership and title in its respective copies of such Software. Except as otherwise provided herein, Buyer is hereby granted a nonexclusive, nontransferable royalty free license to use the Software incorporated into the Goods solely for purposes of Buyer properly utilizing such Goods purchased from Seller. All other Software shall be furnished to, and used by, Buyer only after execution of Seller's (or the licensor's) applicable standard license agreement, the terms of which are incorporated herein by reference.

18. DRAWINGS: Seller's prints and drawings (including without limitation, the underlying technology) furnished by Seller to Buyer in connection with this agreement are the property of Seller and Seller retains all rights, including without limitation, exclusive rights of use, licensing and sale. Possession of such prints or drawings does not convey to Buyer any rights or license, and Buyer shall return all copies (in whatever medium) of such prints or drawings to Seller immediately upon request therefore.

18. ASSIGNMENT: Buyer shall not assign its rights or delegate its duties hereunder or any interest herein without the prior written consent of Seller, and any such assignment, without such consent, shall be void.

19. GENERAL PROVISIONS: These terms and conditions supersede all other communications, negotiations and prior oral or written statements regarding the subject matter of these terms and conditions. No change, modification, rescission, discharge, abandonment, or waiver of these terms and conditions shall be binding upon the Seller unless made in writing and signed on its behalf by a duly authorized representative of Seller. No conditions, usage of trade, course of dealing or performance, understanding or agreement purporting to modify, vary, explain, or supplement these terms and conditions shall be binding unless hereafter made in writing and signed by the party to be bound, and no modification or additional terms shall be applicable to this agreement by Seller's receipt, acknowledgment, or acceptance of purchase orders, shipping instruction forms, or other documentation containing terms at variance with or in addition to those set forth herein. Any such modifications or additional terms are specifically rejected and deemed a material alteration hereof. If this document shall be deemed an acceptance of a prior offer by Buyer, such acceptance is expressly conditional upon Buyer's assent to any additional or different terms set forth herein. No waiver by either party with respect to any breach or default or of any right or remedy, and no course of dealing, shall be deemed to constitute a continuing waiver of any other breach or default or of any other right or remedy, unless such waiver be expressed in writing and signed by the party to be bound. All typographical or clerical errors made by Seller in any quotation, acknowledgment or publication are subject to correction.

The validity, performance, and all other matters relating to the interpretation and effect of this agreement shall be governed by the law of the state of Missouri. Buyer and Seller agree that the proper venue for all actions arising in connection herewith shall be only in Missouri and the parties agree to submit to such jurisdiction. No action, regardless of form, arising out of transactions relating to this contract, may be brought by either party more than two (2) years after the cause of action has accrued. The U.N. Convention on Contracts for the International Sales of Goods shall not apply to this agreement.

¹ Note the definition of "Software" includes "firmware."

Get Connected...



Emerson Network Power Connectivity Solutions has a wide range of cable assemblies and connectors suited for RF, Microwave and Fiber Optic signal transmission. Connectivity Solutions is a vertically integrated supplier of custom, fixed length and semi rigid cable assemblies from DC to 50 GHz. Our product lines deliver custom-engineered products and solutions to satisfy the most demanding and complex requirements.

Emerson Connectivity Solutions products support wire line and wireless communications, data networking, test and measurement, telecomm, broadcast, medical, military, aerospace and industrial applications.



EmersonConnectivity.com
Toll free: 800-247-8256
Phone: 507-833-8822

Connectivity Solutions



EMERSON. CONSIDER IT SOLVED.™



EMERSON™

Network Power

Connectivity Solutions

Emerson Network Power Connectivity Solutions

US Headquarters

3000 Lakeside Drive, Ste. 308N
Bannockburn, IL 60015, USA

North America

299 Johnson Avenue, Ste. 100
Waseca, MN 56093, USA

Toll Free: 800.247.8256

Tel: 507.833.8822

Fax: 507.833.6287

ECOrders@Emerson.com

Europe, Middle East, Africa

Emerson Network Power Connectivity Solutions, Ltd.

11 Bilton Road

Chelmsford

Essex CM1 2UP

England

Tel: +44 1245.359.515

Fax: +44 1245.358.938

EMEAConnectivitySales@Emerson.com

Asia Pacific

Emerson Network Power Connectivity Solutions

(Shanghai) Co., Ltd.

Building 1, No. 800 ShenFu Road

XinZhliang Industry Park

Shanghai, China 201108

Tel: +86 21.5442.7668

Fax: +86 21.5442.7628

APConnectivitySales@Emerson.com

About Emerson Network Power Connectivity Solutions

Emerson Network Power Connectivity Solutions, an Emerson business, serves the needs of wireless communications, military, telephony and data networks, CATV security systems, health care, military and industrial facilities with a full spectrum of RF/microwave and fiber optic connectivity products. For more information, visit www.EmersonConnectivity.com

About Emerson

Emerson (NYSE: EMR), based in St. Louis, is a global leader in bringing technology and engineering together to provide innovative solutions to customers through its network power, process management, industrial automation, climate technologies, and appliance and tools businesses. For more information, visit www.Emerson.com



www.EmersonConnectivity.com

Emerson Network Power

The global leader in enabling business-critical continuity.

- AC Power Systems
- Connectivity
- DC Power Systems
- Embedded Power
- Inbound Power
- Integrated Cabinet
- Outside Plant
- Precision Cooling
- Site Monitoring and Services